



Profesionální lisovací kleště na dutinky **2**



Odizolovací a řezací nářadí **3**



Automatické kleště pro odizolování a řezání vodičů **4**



Řezací, odizolovací a lisovací nářadí pro telekomunikační techniku **4**



Lisovací kleště pro izolované, neizolované dutinky a dvojité dutinky **5**



Lisovací nářadí pro izolované kabelová oka **6**



Lisovací kleště pro neizolované kabelové koncovky **6**



Robustní lisovací kleště pro neizolované kabelové koncovky **7**



Lisovací kleště pro mosazné kabelové koncovky **7**



Ruční hydraulické lisy **8**



Akumulátorový hydraulický lis **9**



Nabíječka k akumulátorům **9**



Akumulátor **9**



Akumulátorový hydraulický lis v kufříku **10**



Akumulátorové hydraulické řezací nářadí v kufříku **11**



Hydraulické řezací nářadí **12**



Řezací nářadí k Cu a Al kabelům **13**



Nářadí pro řezání Cu a Al kabelů a vodičů **14**



Kombinované kleště s izolací do 1000 V~ **14**

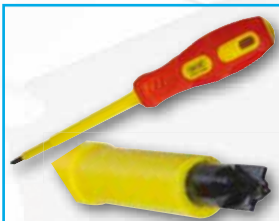

Univerzální šroubovák „kombiprofil“ s izolací do 1000 V ~ **15**

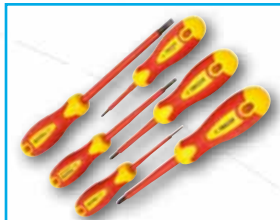

Souprava šroubováků s izolací do 1000V **15**



SD šroubováky s CrV hrotem **16**



Sada SD šroubováků s CrV hrotem **17**



Nářadí pro instalaci stahovacích pásek **18**



Nářadí k utahování a odřezávkových stahovacích pásek **18**



Protahovací péra vodičů do elektroinstalačních trubek **18**



Tepl vzdušná pistole **19**



Blankovací nůž se slzou **19**



Nářadí pro odizolování kabelů **19**



UTILK Nože s čepeli **20**





BD Čepel **21**

B/O Vysvětlení piktogramů hlavičky tabulek

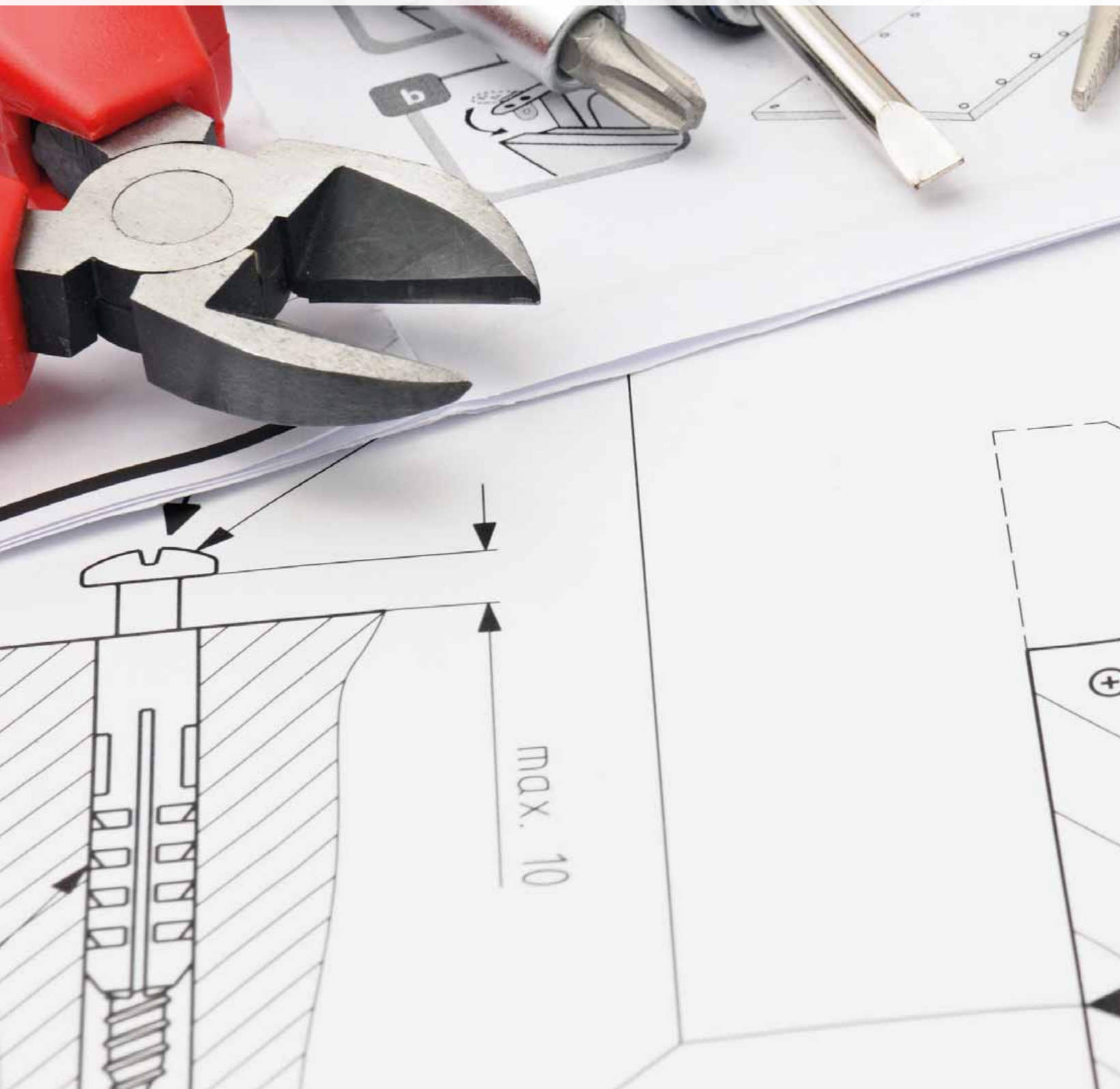
 Hmotnost	 T_o Teplota okolí	 Typ hlavic šroubováků	 Délka náradí
 A_{max} Max. řezný průřez	 d_{max} Max. řezný průměr	 mm^2 Lisovací rozsah	 mm^2 Průřez zapojitelných vodičů
 a Zdvih pístu	 l_{max} Kapacita vyřezávání	 kN_{max} Max. lisovací síla	 Hlavice je otočitelná o 360 stupňů
 Ah Kapacita akumulátoru	 V Napětí akumulátoru	 Typ akumulátoru	 Nastavitelná napínací síla
 w Šířka řezání	 Poznámky, vysvětlivky	 U_n Jmenovité napětí	 Jmenovitý výkon



Profesionální lisovací kleště na izolované, neizolované dutinky a dvojité dutinky

TRACON	 mm ²		
F6L	0,5-6	205 mm	470 g
F25L	6-25	240 mm	620 g
F50L	35-50	240 mm	620 g



F6L





F25L

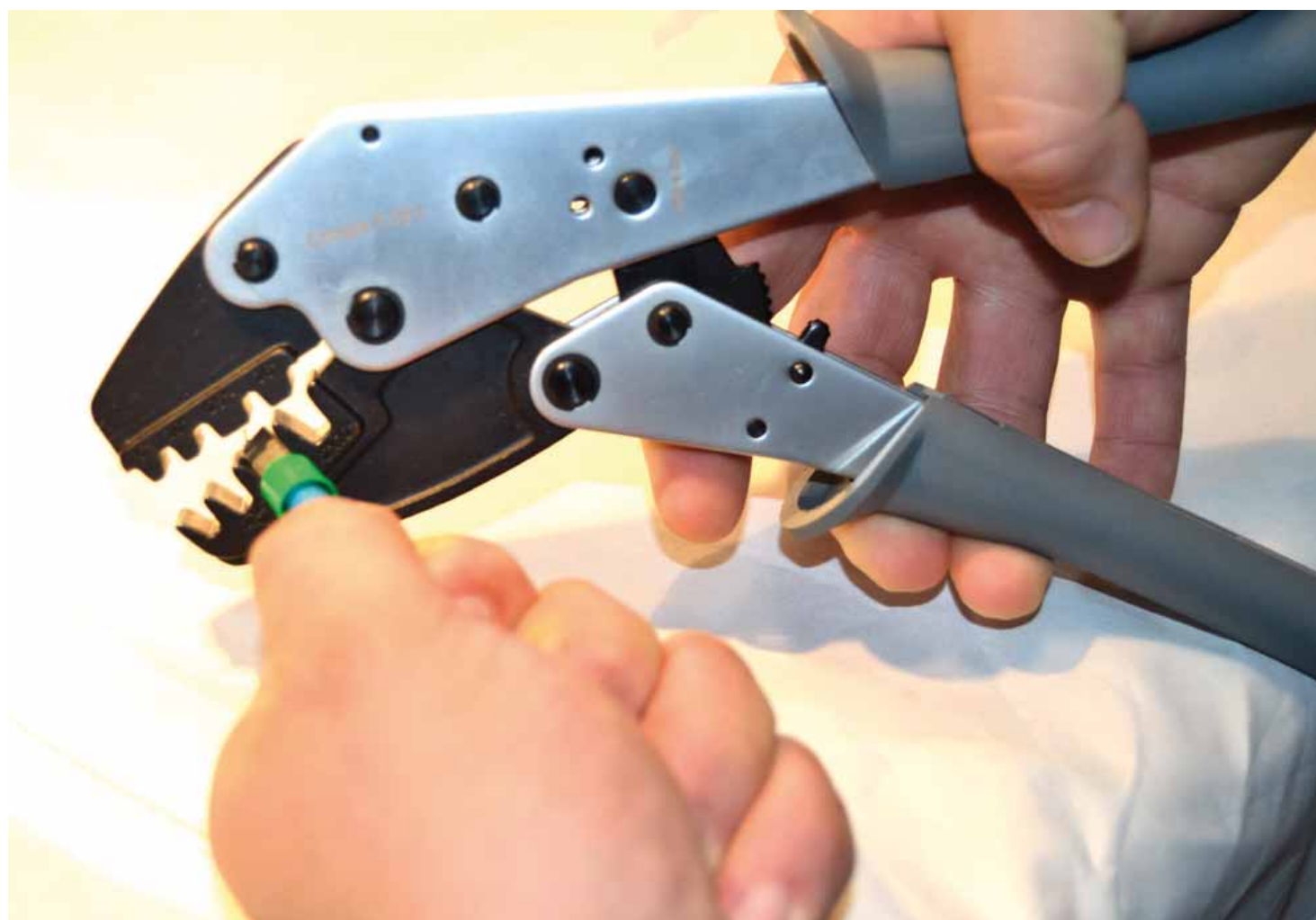

F50L



Odizolovací a řezací nářadí

TRACON	 mm ²		 m
MACS6	0,08-6	205 mm	180 g
MACS16	6-16	205 mm	180 g



Souprava nářadí na lisování konektorů SOLAR11-4AB a SOLAR11-4N

TRACON	 mm ²		 m
SOLAR11-PT	2.5-6	270 mm	725 g / 1710 g





NAČTĚTE KÓD!

- Prohlédněte si naše novinky!
- Buďte informováni!

Náš sortiment se neustále a rychle rozrůstá. Předložený katalog odráží stav k dubnu 2021.

Pro aktuální informace, prosím, navštivte naši internetovou stránku!

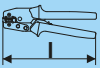
Kleště pro odizolování a řezání vodičů

TRACON	 mm ²		 m
TKCS	0,1-4 (6)	200 mm	175 g
TP700A	0,25-2,5	180 mm	380 g
TP700B	0,75-6	180 mm	380 g
LY731	0,5-6	200 mm	300 g



TKCS



TP700A







TP700B



LY731

Řezací, odizolovací a lisovací nářadí pro telekomunikační techniku

TRACON		 m	
RJ86	220 mm	310 g	RJ11, RJ12, RJ45
RJ468	220 mm	200 g	RJ11, RJ12, RJ45, RJ50
RG317 	230 mm	200 g	BNC, TNC, RG 1,72 / 2,6 / 5,4 / 6,5 / 8,1 mm



RJ86



RJ468



RG317













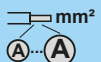
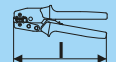

NAČTĚTE KÓD!

- Prohlédněte si naše novinky!
- Buďte informováni!

Náš sortiment se neustále a rychle rozrůstá. Předložený katalog odráží stav k dubnu 2021.

Pro aktuální informace, prosím, navštivte naši internetovou stránku!







Lisovací kleště pro izolované, neizolované dutinky a dvojité dutinky

TRACON		 mm ²		 m
9039		6-16	230 mm	600 g
9102-LT		0,25-2,5	145 mm	160 g
9004-LT		0,5-16	180 mm	320 g
9039A-SPEC		0,25-6	175 mm	400 g
9039B-SPEC		6-16	210 mm	470 g
9039-HEXA		0,25-6	175 mm	400 g
9039A		1,5-6	230 mm	600 g
9039AR		0,5-6	230 mm	600 g
9039BR		10-35	230 mm	600 g
9039B		10-35	230 mm	600 g

 Vysvětlivky piktogramů **B/O**











Univerzální lisovací kleště k izolovaným kabelovým koncovkám

TRACON		 mm ²		 m
LY35C		10-35	490 mm	2.150 g
9006RS		0,5-2,5	230 mm	600 g
9006R		2,5-6	230 mm	600 g
9006		2,5-6	230 mm	600 g











Lisovací kleště pro neizolované kabelové koncovky typu SZ, CL, TH, CS a V

TRACON		 mm ²		 m
HD156R		1,5-6	225 mm	540 g
HD156		1,5-6	247 mm	540 g
KH8		1,5-10	280 mm	470 g
KH14		6-16	280 mm	470 g
KH16		1,5-16	280 mm	470 g



Robustní lisovací kleště pro neizolované kabelové koncovky

TRACON					mm ²		m
KH120					10-95	645 mm	3.000 g
HX50B*					6-50	390 mm	1.300 g
HX120B*					10-120	630 mm	4.000 g
HX150B*					25-150	650 mm	3.200 g

* Lisovací rozsah závisí od typu použité kabelové koncovky.



KH120

HX50B
HX120B
HX150B

HX50B-FEJ
Náhradní čelisti – 1 pár
k lisovacímu nářadí HX50B
pro Cu a Al neizolované koncovky







HX120B-FEJ
Náhradní čelisti – 1 pár
k lisovacímu nářadí HX120B
pro Cu a Al neizolované koncovky



HX150B-FEJ
Náhradní čelisti – 1 pár
k lisovacímu nářadí HX150B
pro Cu a Al neizolované koncovky

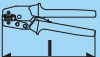

Lisovací kleště pro mosazné kabelové koncovky

TRACON			mm ²		m
LY03BR			0,5-6	230 mm	600 g
LY03B			0,5-6	230 mm	600 g

 Vysvětlivky
piktogramů **B/0**

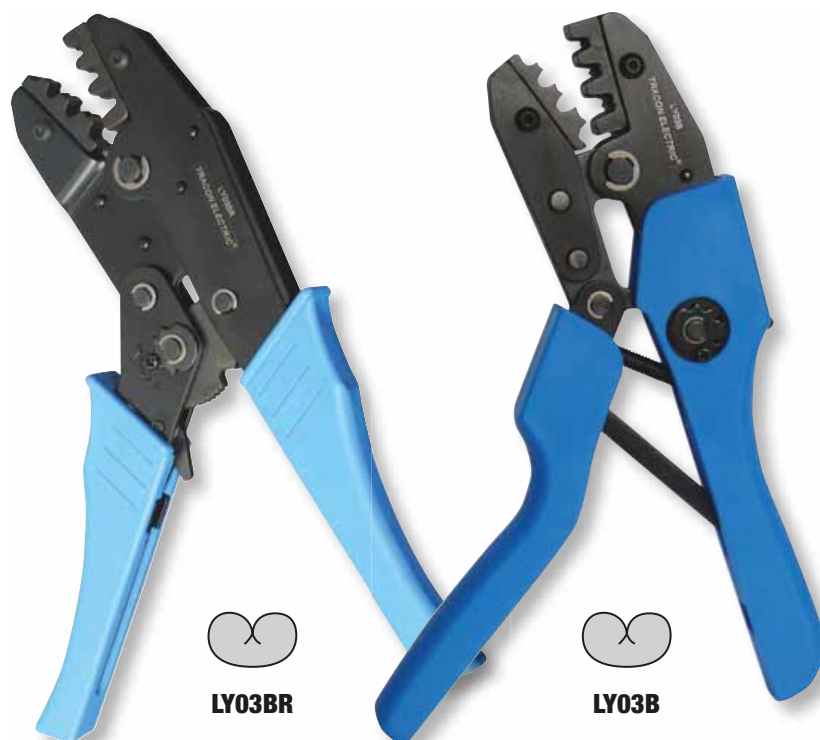





LY03BR



LY03B

Ruční hydraulický lis

TRACON	 mm ²	 kN max			
D31*	4-95	35	360°	200 mm	1.550 g
D51*	10-185	55	180°	365 mm	2.500 g
D52F*	10-240	67	180°	375 mm	2.800 g
C120F*	16-400	120	180°	590 mm	7.000 g
KHP70**	4-70	50	–	375 mm	3.000 g
KHP240**	16-240	120	–	480 mm	6.250 g

* Příslušenství: Plastová přenosná taška

** Příslušenství: Plastová přenosná taška + lisovací čelisti



Čelistní vložky (páry) k hydraulickému lisu D31

TRACON		Cu mm ²	Al mm ²
D31-4	KZ 4	4	-
D31-6	KZ 5	6	4
D31-10	KZ 6	10	6
D31-16	KZ 8	16	10
D31-25	KZ 10	25	16
D31-35	KZ 12	35	25
D31-50	KZ 14	50	35
D31-70	KZ 16	70	50
D31-95	KZ 18	95	70



Čelistní vložky (páry) k hydraulickému lisu D52F

TRACON	Cu mm ²	Al mm ²
D52F-1016	10-16	10
D52F-2535	25-35	16-25
D52F-5070	50-70	50-35
D52F-95120	95-120	70-95
D52F-150	150	120
D52F-185	185	150
D52F-240	240	185



Čelistní vložky (páry) k hydraulickému lisu D51

TRACON		Cu mm ²	Al mm ²
D51-10-120	KZ 6	10	6
	KZ 20	120	95
D51-16-70	KZ 8	16	10
	KZ 16	70	50
D51-25-95	KZ 10	25	16
	KZ 18	95	70
D51-35-50	KZ 12	35	25
	KZ 14	50	35
D51-150	KZ 22	150	120
D51-185	KZ 25	185	150











Čelistní vložky (páry) k hydraulickému lisu C120F

TRACON	Cu mm ²	Al mm ²
C120F-16	16	-
C120F-25	25	16
C120F-35	35	25
C120F-50	50	35
C120F-70	70	50
C120F-95	95	70
C120F-120	120	95
C120F-150	150	120
C120F-185	185	150
C120F-240	240	185
C120F-300	300	240
C120F-400	400	300



Akumulátorový hydraulický lis

TRACON		 mm ²	 kN max			 m
D31E		4-95	35	360°	200 mm	1.550 g
D55E		10-185	55	340°	315 mm	3.250 g
D62E		6-240	62	340°	320 mm	3.550 g

Příslušenství:

- Nabíječka k akumulátorům, AKKUT1
- Akumulátor, AKKU1
- Kovový přenosný kufřík



Čelistní vložky (páry) k hydraulickému lisu D62E

TRACON		Cu mm ²	Al mm ²
D62-10	KZ 6	10	6
D62-16	KZ 8	16	10
D62-25	KZ 10	25	16
D62-35	KZ 12	35	25
D62-50	KZ 14	50	35
D62-70	KZ 16	70	50
D62-95	KZ 18	95	70
D62-120	KZ 20	120	95
D62-150	KZ 22	150	120
D62-185	KZ 25	185	150
D62-240	KZ 28	240	185
D62-300	KZ 32	300	240



Čelistní vložky (páry) k hydraulickému lisu D31E

TRACON		Cu mm ²	Al mm ²
D31-4	KZ 4	4	-
D31-6	KZ 5	6	4
D31-10	KZ 6	10	6
D31-16	KZ 8	16	10
D31-25	KZ 10	25	16
D31-35	KZ 12	35	25
D31-50	KZ 14	50	35
D31-70	KZ 16	70	50
D31-95	KZ 18	95	70







Čelistní vložky (páry) k hydraulickému lisu D55E

TRACON		Cu mm ²	Al mm ²
D51-10-120	KZ 6	10	6
	KZ 20	120	95
D51-16-70	KZ 8	16	10
	KZ 16	70	50
D51-25-95	KZ 10	25	16
	KZ 18	95	70
D51-35-50	KZ 12	35	25
	KZ 14	50	35
D51-150	KZ 22	150	120
D51-185	KZ 25	185	150





Nabíječka k akumulátorům

TRACON		 V	 Ah	
AKKUT1	230 V AC	18 V	2100 mAh	Li-ion











Akumulátor

TRACON	 V	 Ah	
AKKU1	18 V	2000 mAh	Li-ion



Akumulátorový hydraulický lis v kufříku









TRACON	 mm ²	 kN max	 350°	 420 mm	 V	 Ah	 Li-ion	 230 V AC	 m
DK60E	16-300	60	350°	420 mm	18 V	2×3200 mAh	Li-ion	230 V AC	4.900 g

Lisovací síla	60 kN
posun	17 mm
Počet lisování na jedno nabití	320 lisování (Cu 150mm ²)
Čas lisování	3-6s (závislý od tloušťky kabelu)
Napětí akumulátoru	18 V
Kapacita baterie	3.2 Ah
Hmotnost (včetně akumulátoru)	4.9 kg
Čas na úplné nabití	1 hodina
Kufr	plastová krabice

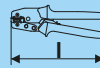
Příslušenství (podle velikosti)	
Lisovací čelisti	16, 25, 35, 50, 70, 95, 120, 150, 185, 240, 300 mm ²
Akumulátor	2 ks
Nabíječka	1 ks
Těsnění k hlavicím	1 sada
Těsnění k bezpečnostnímu ventilu	1 sada



Akumulátorové hydraulické řezací nářadí v kufříku

TRACON	 d_{max}	 kN_{max}			 V	 Ah		 lpr	 m
DKV105	105 mm	120	360°	610 mm	18 V	2×5000 mAh	Li-ion	230 V AC	8.550 g

Řezací síla	120 kN
posun	108 mm
Interval řezání	Ø 105 mm CU/AL kabel a pancířované kabely
Počet řezů na jedno nabití	~70 řezů
Čas řezání	15-30s (závisí na velikosti a materiálu kabelu)
Napětí akumulátoru	18 V
Kapacita baterie	5.0 Ah
Čas na úplné nabití	1 hodina
Rozměry	610 × 430 × 85mm
Kufr	plastová krabice
Příslušenství (podle velikosti)	
Nabíječka	2 ks
Nabíječka	1 ks
Těsnění k hlavicím	1 sada
Těsnění k bezpečnostnímu ventilu	1 sada



Hydraulické řezací nářadí



TRACON	kN max	l _{max}	a	m
HKS-15	150 kN	max. 2-3 mm	25 mm	6.2 kg

- Součástí lisu:
- Řezací čelisti: Ø21,8mm; Ø27,6mm; Ø34,1mm; Ø42,7mm; Ø48,7mm; Ø60,5mm; □32×32mm
 - Plastový kufr

Používá se k vyřezávání kruhových otvorů na ocelovo-plechových rozvodných skříních, montážních panelech. Ulehčuje montáž ovládacích hlavice, kontrolky, tlačítek, spínačů. Možnost vyřezávání čtvercových výřezů pro panelové měřicí přístroje jako i otvorů pro průchodky na přírubách ocelových rozvaděčů.



Příslušenství k hydraulickému řezacímu lisu HKS-15



TRACON		l _{max}
HKS-15-20	Průchodka MG20	Ø20 mm
HKS-15-22	Ovládací hlavice Ø22 mm	Ø22 mm
HKS-15-25	Průchodka MG25	Ø25 mm
HKS-15-32	Průchodka MG32	Ø32 mm
HKS-15-40	Průchodka MG40	Ø40 mm
HKS-15-50	Průchodka MG50	Ø50 mm
HKS-15-63	Průchodka MG63	Ø63 mm
HKS-15-PG13,5	Průchodka PG13,5	Ø20 mm
HKS-15-PG16	Průchodka PG16	Ø23,5 mm
HKS-15-PG21	Průchodka PG21	Ø29,5 mm
HKS-15-PG29	Průchodka PG29	Ø36 mm
HKS-15-PG36	Průchodka PG36	Ø46 mm
HKS-15-PG42	Průchodka PG42	Ø51 mm
HKS-15-PG48	Průchodka PG48	Ø59 mm
HKS-15-43×43	Panelový přístroj s rámem 48×48 mm	□43×43 mm
HKS-15-68×68	Panelový přístroj s rámem 72×72 mm	□68×68 mm
HKS-15-92×92	Panelový přístroj s rámem 96×96 mm	□92×92 mm
HKS-15-BSZ10	Utahovací šroub, 105 mm	max. 2-3 mm

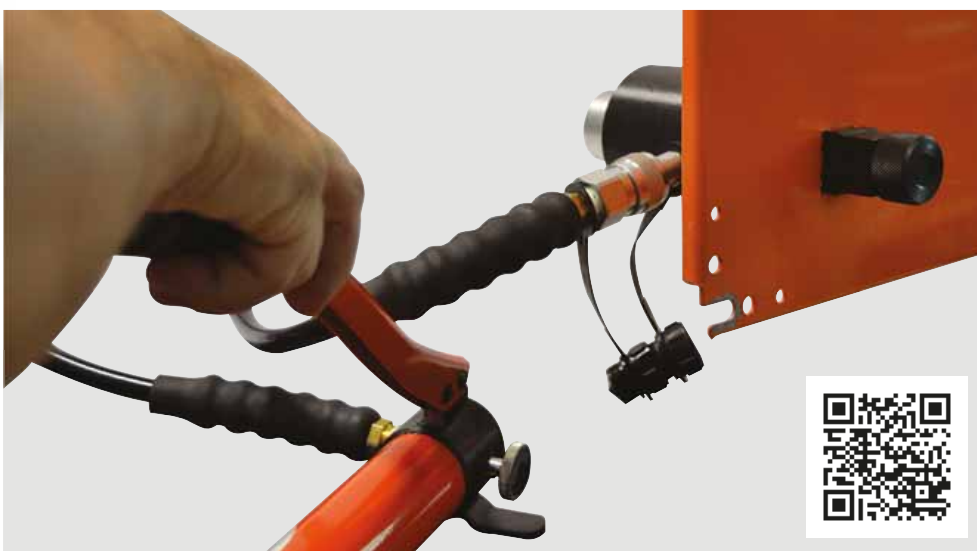

Řezací nářadí k Cu a Al kabelům

TRACON	d _{max} 	NYN 	NYN 	NYCWY 	NAYY 	NAYY 	AYCWY
RKV300	35 mm	max. 4×50	max. 1×240	max. 4×50/25	max. 4×70	max. 1×300	max. 4×50/25
RKV700	60 mm	max. 4×95	max. 1×240	max. 4×95/50	max. 4×120	max. 1×300	max. 4×95/35
RKV1000	95 mm	–	–	max. 4×240/120	max. 4×240	max. 1×500	–



RKV300



RKV700



Teleskopická rukojeť

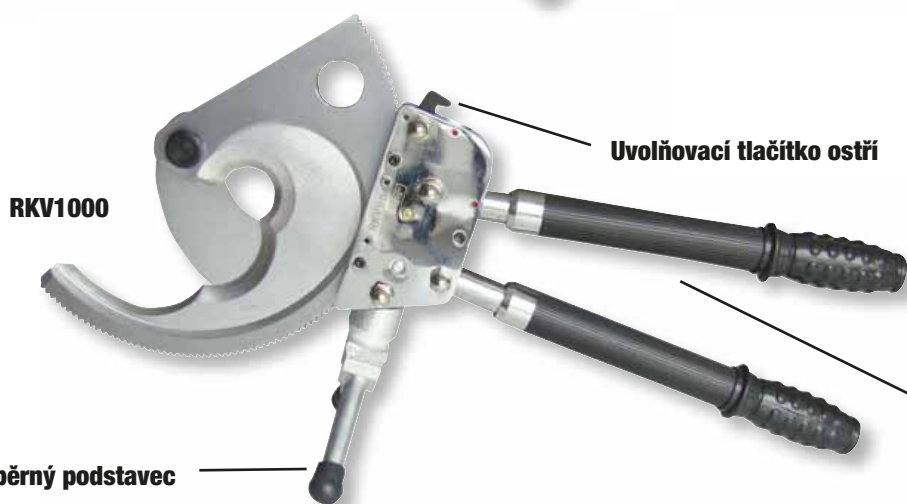

RKV1000

Uvolňovací tlačítko ostří

Podpěrný podstavec



Teleskopická rukojeť



Nářadí pro řezání Cu a Al kabelů a vodičů

TRACON	A _{max} 	d _{max} 		m
CC22	16 mm ²	5,5 mm	150 mm	190 g
CC38	25 mm ²	6,5 mm	210 mm	350 g
CC60	35 mm ²	8 mm	230 mm	510 g
CC80	70 mm ²	9 mm	235 mm	510 g
CC100	100 mm ²	15 mm	320 mm	500 g
CC250	250 mm ²	17 mm	600 mm	1250 g
CC500	500 mm ²	25 mm	800 mm	2850 g



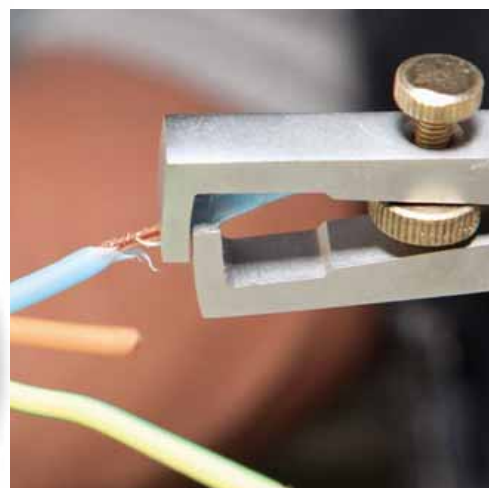

Kombinované kleště s izolací do 1000 V~

TRACON		m 	
KF-1000	160 mm	230 g	kombinované kleště
KF-1000-2	200 mm	370 g	kombinované kleště
KB-1000	160 mm	230 g	odizolovací kleště
KC-1000	160 mm	210 g	štípací kleště
KL-1000	160 mm	230 g	ploché kleště



Šroubováky s izolací do 1000 V~, SD



TRACON		
SD375F		3×75 mm
SD4100F		4×100 mm
SD5125F		5×125 mm
SD6100F		6×100 mm
SD6125F		6×125 mm
SD6150F		6×150 mm
SD375S		3×75 mm (PH0)
SD4100S		4×100 mm
SD5125S		5×125 mm (PH1)
SD6100S		6×100 mm (PH2)
SD6125S		6×125 mm (PH2)
SD6150S		6×150 mm (PH2)



RELEVANT STANDARD
EN 60900



Univerzální šroubováky „kombiprofil“ s izolací do 1000 V ~

TRACON		
SDDK4100S		4×100 mm
SDDK5125S		5×125 mm (PZ1)
SDDK6150S		6×150 mm (PZ2)

Šroubováky mají speciálně vytvarovaný hrot umožňující dotahování svorkových šroubů používaných v elektroměrech, jističích, stykačích, které se nacházejí v sortimentu společnosti Tracon Electric s.r.o

Integrují výhody hrotů plochého a křížového šroubováku, což umožňuje lehčí a bezpečnější dotahování svorek přístrojů.





VDE TEST REPORT NO.:
40011797



RELEVANT STANDARD
EN 60900



Souprava šroubováků s izolací do 1000V

TRACON		
KSET1000	1.0 × 5.5 × 125 mm	PH2 × 100 mm
	0.8 × 4.0 × 100 mm	PH1 × 80 mm
	0.4 × 2.5 × 75 mm	PH0 × 60 mm

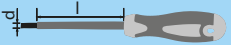

SD šroubováky s CrV hrotem

Ploché (SL) šroubováky

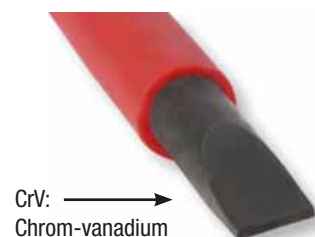

TRACON			
SD2575SL	SL 2,5 × 75 mm	CrV	52 g
SD40100SL	SL 4,0 × 100 mm	CrV	58 g
SD55125SL	SL 5,5 × 125 mm	CrV	90 g
SD65150SL	SL 6,5 × 150 mm	CrV	127 g



CrV: →
Chrom-vanadium

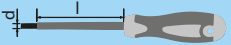

Křížové(Philips, PH) šroubováky



TRACON			
SD3060PH0	PH0 3,0 × 60 mm	CrV	49 g
SD5080PH1	PH1 5,0 × 80 mm	CrV	73 g
SD60100PH2	PH2 6,0 × 100 mm	CrV	102 g
SD80150PH3	PH3 8,0 × 150 mm	CrV	178 g



CrV: →
Chrom-vanadium

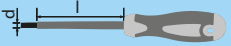

Pozidriv(PZ) šroubováky

TRACON			
SD3060PZ0	PZ0 3,0 × 60 mm	CrV	49 g
SD5080PZ1	PZ1 5,0 × 80 mm	CrV	73 g
SD60100PZ2	PZ2 6,0 × 100 mm	CrV	102 g
SD80150PZ3	PZ3 8,0 × 150 mm	CrV	178 g





CrV: →
Chrom-vanadium

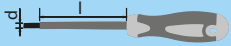

SD šroubováky s CrV hrotem

Kombiprofi (SLPZ) šroubováky

TRACON			
SD5080SLPZ1	SL/PZ1 5,0 × 80 mm	CrV	73 g
SD60100SLPZ2	SL/PZ2 6,0 × 100 mm	CrV	102 g



CrV: →
Chrom-vanadium

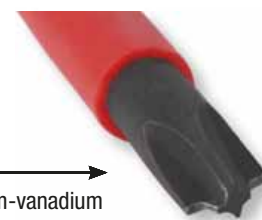



SD5080SLPZ1



SD60100SLPZ2



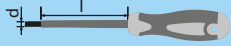

Sada 8 šroubováků v pouzdře

TRACON			
SDSETOF8			
-	SD2575SL	SL 2,5 × 75 mm	CrV 52 g
-	SD40100SL	SL 4,0 × 100 mm	CrV 58 g
-	SD55125SL	SL 5,5 × 125 mm	CrV 90 g
-	SD65150SL	SL 6,5 × 150 mm	CrV 127 g
-	SD3060PH0	PH0 3,0 × 60 mm	CrV 49 g
-	SD5080PH1	PH1 5,0 × 80 mm	CrV 73 g
-	SD60100PH2	PH2 6,0 × 100 mm	CrV 102 g
-	SD80150PH3	PH3 8,0 × 150 mm	CrV 178 g

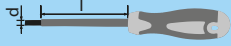

Sada 12 šroubováků v pouzdře

TRACON			
SDSETOF12			
-	SD2575SL	SL 2,5 × 75 mm	CrV 52 g
-	SD40100SL	SL 4,0 × 100 mm	CrV 58 g
-	SD55125SL	SL 5,5 × 125 mm	CrV 90 g
-	SD65150SL	SL 6,5 × 150 mm	CrV 127 g
-	SD3060PH0	PH0 3,0 × 60 mm	CrV 49 g
-	SD5080PH1	PH1 5,0 × 80 mm	CrV 73 g
-	SD60100PH2	PH2 6,0 × 100 mm	CrV 102 g
-	SD80150PH3	PH3 8,0 × 150 mm	CrV 178 g
-	SD3060PZ0	PZ0 3,0 × 60 mm	CrV 49 g
-	SD5080PZ1	PZ1 5,0 × 80 mm	CrV 73 g
-	SD60100PZ2	PZ2 6,0 × 100 mm	CrV 102 g
-	SD80150PZ3	PZ3 8,0 × 150 mm	CrV 178 g





NAČTĚTE KÓD!

- Prohlédněte si naše novinky!
- Buďte informováni!

Náš sortiment se neustále a rychle rozrůstá.
Předložený katalog odráží stav k dubnu 2021.

Pro aktuální informace, prosím,
navštivte naši internetovou stránku!

Nářadí pro instalaci stahovacích pásek

TRACON		
TG007	2.2-8 mm	220 g
TG008	2.2-4.8 mm	320 g



TG008





TG007



Nářadí k utahování a odřezáničkových stahovacích pásek

TRACON		
TGF	4,6 - 7,9mm	620 g





Protahovací struny vodičů do elektroinstalačních trubek

TRACON			
TBSZ-5	5 m		Plastová struna, s kovovou hlavicí a smyčkou
TBSZ-10	10 m	∅ = 3 mm	
TBSZ-20	20 m		
TBSZS-5	5 m		Ocelová spirála
TBSZS-10	10 m	∅ = 3.2 mm	
TBSZS-20	20 m		
TBSZF-5	5 m		Plochá ocelová struna
TBSZF-10	10 m	d = 3.2 mm	
TBSZF-20	20 m		



TBSZS



TBSZF



TBSZ



Teplovzdušná pistole

TRACON	U _n				
HLF-02	230 V AC	1.000/2.000 W	350/600 °C	1450 g	300 / 500 l/min

SMRŠŤOVACÍ PRODUKTY

D/2-D/13

Blankovací nůž se slzou

TRACON		
BK-01	160 mm	70 g



Nářadí pro odizolování kabelů

TRACON		max. ∅	
KBY	200 mm	12 mm	95 g



NAČTĚTE KÓD!

- Prohlédněte si naše novinky!
- Buďte informováni!

Náš sortiment se neustále a rychle rozrůstá.
Předložený katalog odráží stav k dubnu 2021.

Pro aktuální informace, prosím,
navštivte naši internetovou stránku!

UTILK Nože s čepelí

TRACON					
UTILK01			168×35×18 mm l=110; d=18; x=0,7 (×4)	Zn + TPR	250 g
UTILK02			178×33×19 mm l=110; d=18; x=0,7 (×1)	Zn + TPR	250 g
UTILK03			155×33×19 mm l=110; d=18; x=0,7 (×1)	ABS + TPR	125 g
UTILK04			175×41×27 mm l = 62; d=19; x=0,6 (×1)	Al + TPR	194 g
UTILK05			149×19×17 mm l=90; d=12.5; x=0,2mm; x1	ABS	59 g
UTILK06			140×23×18 mm l=90; d=12.5; x=0,2mm; x1	Al	80 g
UTILK07			145×22×18 mm l=82; d=9; x=0,6mm; x1	TPR	54 g
UTILK08			145×21×17 mm l=82; d=9; x=0,6mm; x1	ABS	50 g

UTILK01
S rukojetí ze zinku,
s gumovou vložkou

UTILK05
Flexibilní čepel SK4 s
pružinovou fixací

UTILK02
S rukojetí ze slitiny zinku,
s gumovou vložkou

UTILK06
Flexibilní čepel SK4 s
pevnou fixací



UTILK03
S rukojetí z ABS,
s gumovou vložkou

UTILK07
Úzká SK4 čepel s
pružinovou fixací, s držákem

UTILK04
Nůž s trapézovou čepelí,
hliníková rukojeť s gumovou vložkou

UTILK08
Úzká SK4 čepel s
pružinovou fixací

BD Čepele

TRACON		
BD02	l=90; d=12,5; x=0,2mm; (×30)	38 g
BD05	l=110; d=18; x=0,5mm; (×10)	105 g
BD06	l=110; d=18; x=0,6mm; (×10)	115 g
BD07	l=110; d=18; x=0,7mm; (×10)	125 g
BDT06	l=62; d=19; x=0,6mm; (×10)	92 g
BD069	l=82; d=9; x=0,6mm; (×10)	38 g



Mimořádně ostrá čepel • 5× odolnější než běžné čepel • Nerezavějící ocel

- Laserově tvarované hrany čepelí zabezpečující vyšší tvrdost
- Těž pro materiály s vyšší tvrdostí • Nástrojářská ocel SK4



NAČTĚTE KÓD!

- Prohlédněte si naše novinky!
- Buďte informováni!

Náš sortiment se neustále a rychle rozrůstá.
Předložený katalog odráží stav k dubnu 2021.

Pro aktuální informace, prosím,
navštivte naši internetovou stránku!