



Kliješta za završne tuljke 2



Kliješta za skidanje izolacije i sječenje 3



Univerzalna kliješta za skidanje izolacije i sječenje 4



Kliješta za komunikacijsku tehniku 4



Univerzalna kliješta za prešanje neizoliranih i izoliranih, jednostrukih i dvostrukih završnih tuljaka 5



Univerzalna kliješta za prešanje izoliranih kablskih i natičnih stopica 6



Univerzalna kliješta za prešanje neizoliranih kablskih stopica 6



Mehanička kliješta za prešanje neizoliranih kablskih stopica 7



Univerzalna kliješta za prešanje neizoliranih natičnih stopica 7



Hidraulična kliješta za prešanje, na ručni pogon 8



Hidraulični alat za prešanje, s akumulatorom 9



Punjač za akumulatore 9



Akumulator 9



Elektro-hidraulični alat za prešanje s kalupima, u torbi 10



Elektro-hidraulični alat za sječenje kabela, u torbi 11



Hidraulična preša za bušenje 12



Kliješta s transmisijom za sječenje Cu i Al kabela 13



Kliješta za sječenje bakre nog i aluminijskog kabela 14

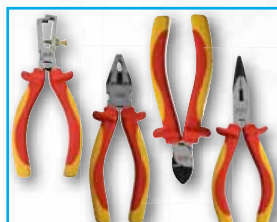

Kliješta izolirana za 1000 V 14



Odvijači za 1000 V, kombi-profil 15

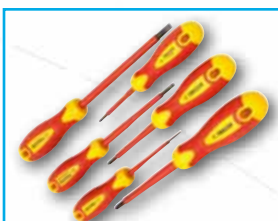

Set odvijača izoliranih za 1000 V 15



SD odvijači s CrV vrškom 16



SD odvijači s CrV vrškom 17



Alat za zatezanje i sječenje kablskih vezica 18



Alat za zatezanje i sječenje čeličnih kablskih vezica 18



Užad (sajle) za uvlačenje 18



Fen za vrući zrak 19



Nož s dvije oštrice za skidanje izolacije 19



Alat za skidanje izolacije 19



UTILK Skalpel 20



BD Oštrice 21

B



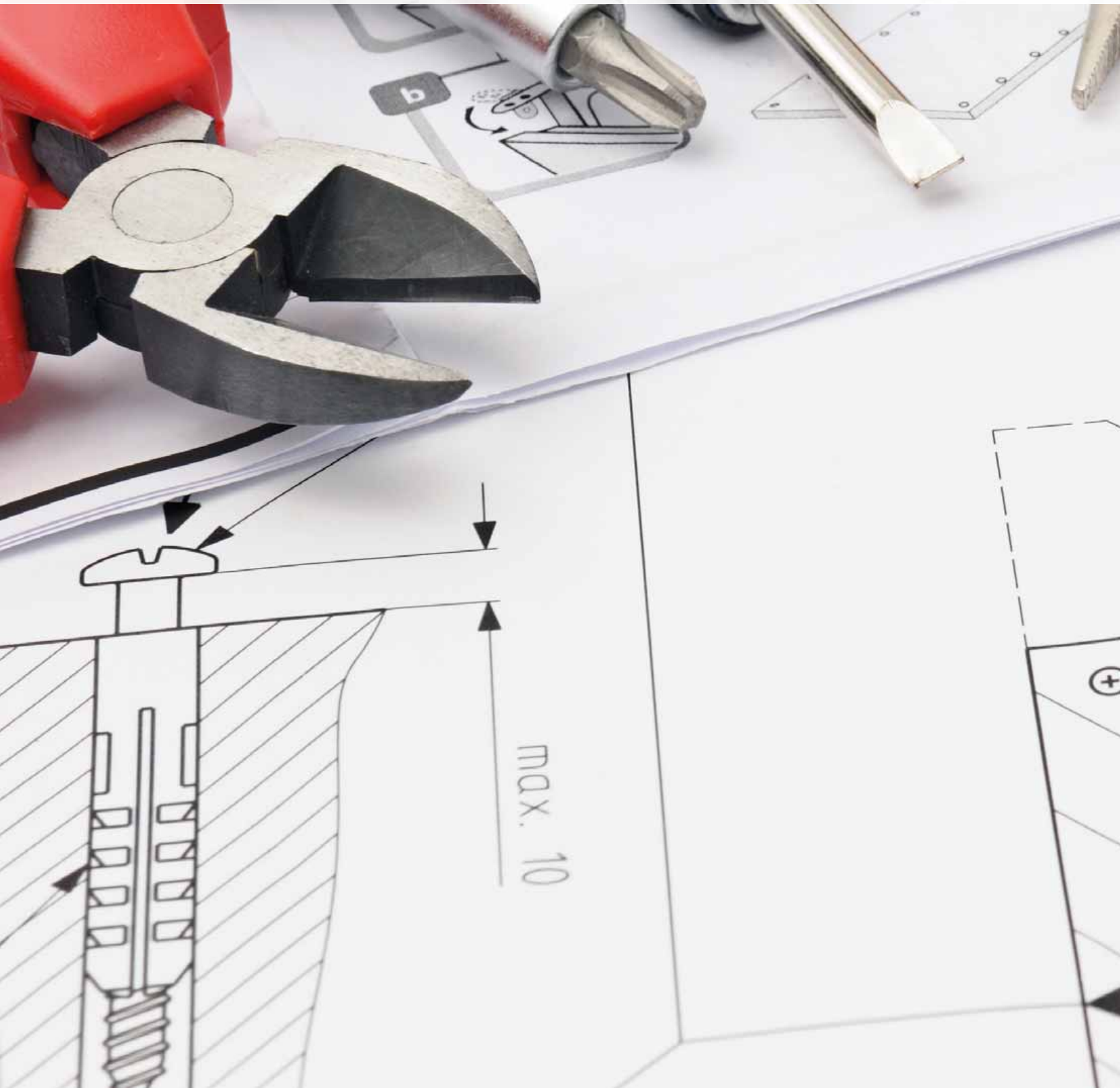

Piktogrami za zaglavlje tablica

 Masa	 Temperatura okoline	 Tipovi odvijača	 Duljina alata
 A_{max} Max. presjek sječenja	 d_{max} Max. promjer sječenja	 mm^2 Područje prešanja	 mm^2 Max. presjek vodiča
 Duljina klipnog udara	 l_{max} Kapacitet bušenja	 kN_{max} Max. sila prešanja	 Glava je okretna 360°
 Snaga akumulatora (Ah)	 Napon akumulatora (V)	 Tip akumulatora	 Promjenjiva sila napinjanja
 Širina sječenja	 Napomena i dopuna	 U_n Nazivni napon (V)	 Nazivna snaga



Kliješta za završne tuljke

TRACON	 mm ²		
F6L	0,5-6	205 mm	470 g
F25L	6-25	240 mm	620 g
F50L	35-50	240 mm	620 g



F6L





F25L

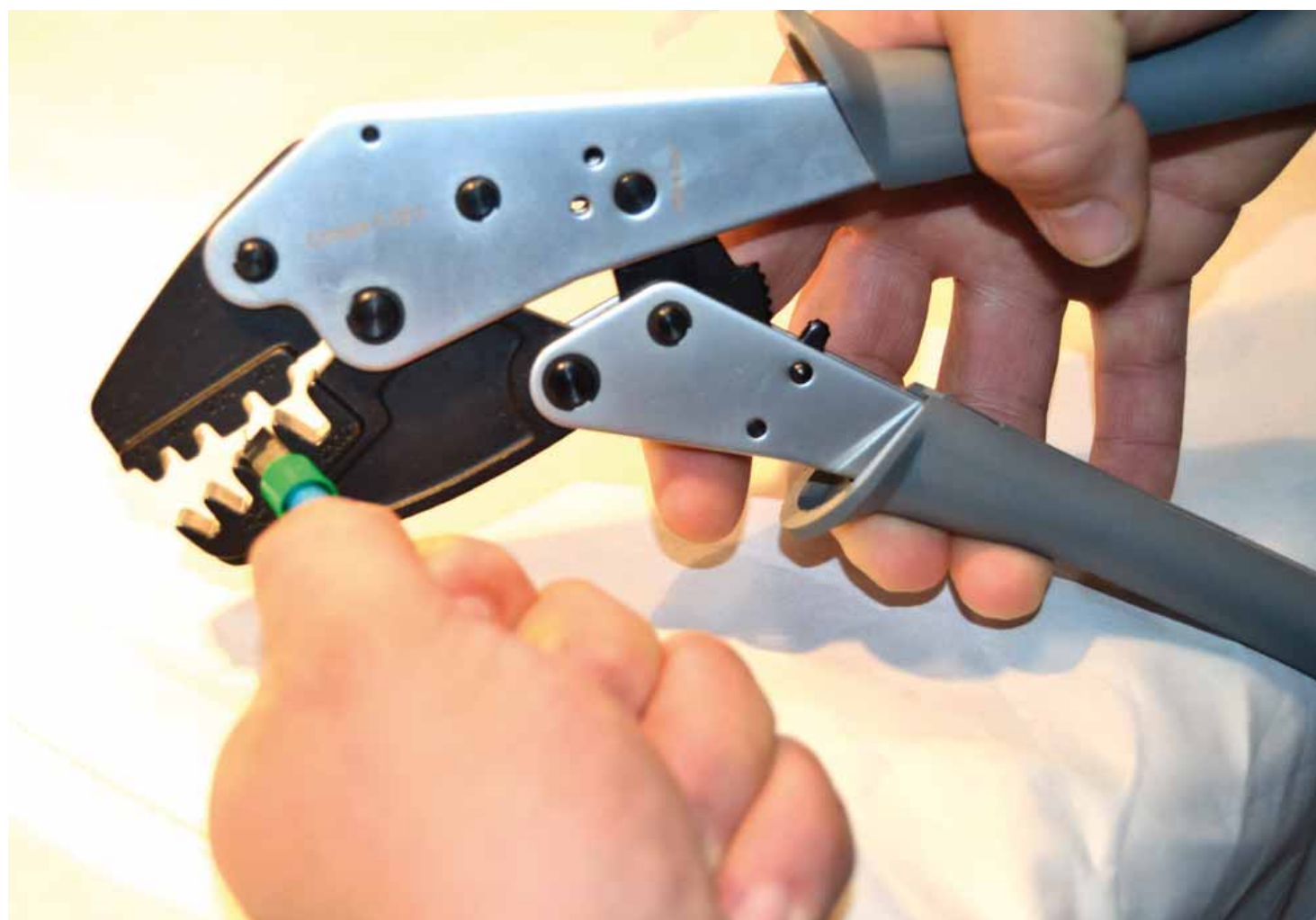

F50L



Kliješta za skidanje izolacije i sječenje

TRACON	 mm ²		 m
MACS6	0,08-6	205 mm	180 g
MACS16	6-16	205 mm	180 g



Set kliješta za priključnice SOLAR11-4AB i SOLAR11-4N

TRACON	 mm ²		 m
SOLAR11-PT	2.5-6	270 mm	725 g / 1710 g





UČITAJTE ŠIFRU!

- Pogledajte naše novosti
- Budite u tijeku

Naša ponuda se brzo i kontinuirano razvija!
 Katalog prikazuje stanje u travnju 2021. godine.
 Za aktualne informacije posjetite našu
 web stranicu!

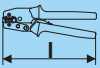
Univerzalna kliješta za skidanje izolacije i sječenje

TRACON	 mm ²		 m
TKCS	0,1-4 (6)	200 mm	175 g
TP700A	0,25-2,5	180 mm	380 g
TP700B	0,75-6	180 mm	380 g
LY731	0,5-6	200 mm	300 g



TKCS



TP700A







TP700B



LY731

Kliješta za komunikacijsku tehniku

TRACON		 m	
RJ86	220 mm	310 g	RJ11, RJ12, RJ45
RJ468	220 mm	200 g	RJ11, RJ12, RJ45, RJ50
RG317 	230 mm	200 g	BNC, TNC, RG 1,72 / 2,6 / 5,4 / 6,5 / 8,1 mm



RJ86



RJ468



RG317











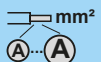
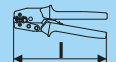



UČITAJTE ŠIFRU!

- Pogledajte naše novosti
- Budite u tijeku

Naša ponuda se brzo i kontinuirano razvija!
 Katalog prikazuje stanje u travnju 2021. godine.
 Za aktualne informacije posjetite našu
 web stranicu!







Univerzalna kliješta za prešanje neizoliranih i izoliranih, jednostrukih i dvostrukih završnih tuljaka

TRACON		 mm ²		
9039		6-16	230 mm	600 g
9102-LT		0,25-2,5	145 mm	160 g
9004-LT		0,5-16	180 mm	320 g
9039A-SPEC		0,25-6	175 mm	400 g
9039B-SPEC		6-16	210 mm	470 g
9039-HEXA		0,25-6	175 mm	400 g
9039A		1,5-6	230 mm	600 g
9039AR		0,5-6	230 mm	600 g
9039BR		10-35	230 mm	600 g
9039B		10-35	230 mm	600 g

 Piktogrami **B/0**









Univerzalna kliješta za prešanje izoliranih kabljskih stopica

TRACON		mm ²		m
LY35C		10-35	490 mm	2.150 g
9006RS		0,5-2,5	230 mm	600 g
9006R		2,5-6	230 mm	600 g
9006		2,5-6	230 mm	600 g











Univerzalna kliješta za prešanje neizoliranih kabljskih stopica

TRACON		mm ²		m
HD156R		1,5-6	225 mm	540 g
HD156		1,5-6	247 mm	540 g
KH8		1,5-10	280 mm	470 g
KH14		6-16	280 mm	470 g
KH16		1,5-16	280 mm	470 g



Mehanička kliješta za prešanje neizoliranih kabljskih stopica

TRACON				
KH120		10-95	645 mm	3.000 g
HX50B*		6-50	390 mm	1.300 g
HX120B*		10-120	630 mm	4.000 g
HX150B*		25-150	650 mm	3.200 g

* Područje gnječenja ovisi o tipu i dimenzijama stopica ili spojnih čahura, vidi poglavlje A!



KH120

HX50B
HX120B
HX150B**HX50B-FEJ**

KALUP – Za kliješta tipa HX50B za gnječenje neizoliranih kabljskih stopica od bakra i aluminija.

**HX120B-FEJ**







KALUP – Za kliješta tipa HX120B za gnječenje neizoliranih kabljskih stopica od bakra i aluminija.

**HX150B-FEJ**

KALUP – Za kliješta tipa HX150B za gnječenje neizoliranih kabljskih stopica od bakra i aluminija.



Univerzalna kliješta za prešanje neizoliranih natičnih stopica













TRACON				
LY03BR		0,5-6	230 mm	600 g
LY03B		0,5-6	230 mm	600 g

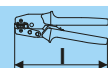

LY03BR

LY03B

Hidraulična kliješta za prešanje, na ručni pogon



TRACON		 mm ²	 kN _{max}			 m
D31*		4-95	35	360°	200 mm	1.550 g
D51*		10-185	55	180°	365 mm	2.500 g
D52F*		10-240	67	180°	375 mm	2.800 g
C120F*		16-400	120	180°	590 mm	7.000 g
KHP70**		4-70	50	–	375 mm	3.000 g
KHP240**		16-240	120	–	480 mm	6.250 g

*Dijelovi kompleta: plastična torba za transport

**Dijelovi kompleta: plastična torba za transport + kalupi za prešanje





Kalupi za hidraulična kliješta D31

TRACON		Cu  mm ²	Al  mm ²
D31-4	KZ 4	4	-
D31-6	KZ 5	6	4
D31-10	KZ 6	10	6
D31-16	KZ 8	16	10
D31-25	KZ 10	25	16
D31-35	KZ 12	35	25
D31-50	KZ 14	50	35
D31-70	KZ 16	70	50
D31-95	KZ 18	95	70





Kalupi za hidraulična kliješta D52F

TRACON	Cu  mm ²	Al  mm ²
D52F-1016	10-16	10
D52F-2535	25-35	16-25
D52F-5070	50-70	50-35
D52F-95120	95-120	70-95
D52F-150	150	120
D52F-185	185	150
D52F-240	240	185





Kalupi za hidraulična kliješta D51

TRACON		Cu  mm ²	Al  mm ²
D51-10-120	KZ 6	10	6
	KZ 20	120	95
D51-16-70	KZ 8	16	10
	KZ 16	70	50
D51-25-95	KZ 10	25	16
	KZ 18	95	70
D51-35-50	KZ 12	35	25
	KZ 14	50	35
D51-150	KZ 22	150	120
D51-185	KZ 25	185	150









Kalupi za hidraulična kliješta C120F

TRACON	Cu  mm ²	Al  mm ²
C120F-16	16	-
C120F-25	25	16
C120F-35	35	25
C120F-50	50	35
C120F-70	70	50
C120F-95	95	70
C120F-120	120	95
C120F-150	150	120
C120F-185	185	150
C120F-240	240	185
C120F-300	300	240
C120F-400	400	300



Hidraulični alat za prešanje, s akumulatorom

TRACON		mm^2	kN_{max}			
D31E		4-95	35	360°	200 mm	1.550 g
D55E		10-185	55	340°	315 mm	3.250 g
D62E		6-240	62	340°	320 mm	3.550 g

Dijelovi kompleta:

- punjač za akumulator, AKKUT1
- akumulator, AKKU1
- Metalna torba za transport



Kalupi za hidraulični alat D62E

TRACON		Cu mm^2	Al mm^2
D62-10	KZ 6	10	6
D62-16	KZ 8	16	10
D62-25	KZ 10	25	16
D62-35	KZ 12	35	25
D62-50	KZ 14	50	35
D62-70	KZ 16	70	50
D62-95	KZ 18	95	70
D62-120	KZ 20	120	95
D62-150	KZ 22	150	120
D62-185	KZ 25	185	150
D62-240	KZ 28	240	185
D62-300	KZ 32	300	240



Kalupi za hidraulični alat D31E

TRACON		Cu mm^2	Al mm^2
D31-4	KZ 4	4	-
D31-6	KZ 5	6	4
D31-10	KZ 6	10	6
D31-16	KZ 8	16	10
D31-25	KZ 10	25	16
D31-35	KZ 12	35	25
D31-50	KZ 14	50	35
D31-70	KZ 16	70	50
D31-95	KZ 18	95	70



Kalupi za hidraulični alat D55E

TRACON		Cu mm^2	Al mm^2
D51-10-120	KZ 6	10	6
	KZ 20	120	95
D51-16-70	KZ 8	16	10
	KZ 16	70	50
D51-25-95	KZ 10	25	16
	KZ 18	95	70
D51-35-50	KZ 12	35	25
	KZ 14	50	35
D51-150	KZ 22	150	120
D51-185	KZ 25	185	150



Punjač za akumulator

TRACON		V	Ah	Li-ion
AKKUT1	230 V AC	18 V	2100 mAh	Li-ion











Akumulator

TRACON	V	Ah	Li-ion
AKKU1	18 V	2000 mAh	Li-ion



Elektro-hidraulični alat za prešanje s kalupima, u torbi









TRACON	 mm ²	 kN max	 350°	 420 mm	 V	 Ah	 Li-ion	 230 V AC	 m
DK60E	16-300	60	350°	420 mm	18 V	2×3200 mAh	Li-ion	230 V AC	4.900 g

Sila prešanja	60KN
Povlačenje	17 mm
Broj prešanja jednim punjenjem	320 prešanja (Cu 150 mm ²)
Vrijeme prešanja	3-6s (ovisi o dimenziji kabela)
Napon akumulatora	18 V
Punjenje	3.2 Ah
Masa (s akumulatorom)	4.9 kg
Vrijeme punjenja	1 sat
Torba za transport	plastična kutija

Pribor (uključen u isporuku):	
Kalupi za prešanje	16, 25, 35, 50, 70, 95, 120, 150, 185, 240, 300 mm ²
Akumulator	2 kom.
Punjač	1 kom.
Brtveni prsten radnog cilindra	1 set
Brtveni prsten sigurnosnog ventila	1 set



Elektro-hidraulični alat za sječenje kabela, u torbi

TRACON	 d_{max}	 kN_{max}	 360°	 610 mm	 18 V	 2x5000 mAh	 Li-ion	 230 V AC	 8.550 g
DKV105	105 mm	120	360°	610 mm	18 V	2x5000 mAh	Li-ion	230 V AC	8.550 g

Sila sječenja	120KN
Povlačenje	108 mm
Područje sječenja	Ø 105 mm Cu/Al kabel i oklopljeni kabel
Broj sječenja jednim punjenjem	~70 sječenja
Vrijeme sječenja	15-30s (ovisi o dimenziji i materijalu kabela)
Napon akumulatora	18 V
Punjenje	5.0 Ah
Vrijeme punjenja	1 sat
Dimenzije	610 × 430 × 85mm
Torba za transport	plastična kutija
Pribor (uključen u isporuku):	
Akumulator	2 kom.
Punjač	1 kom.
Brtveni prsten radnog cilindra	1 set
Brtveni prsten sigurnosnog ventila	1 set



HKS-15 Hidraulična preša za bušenje



TRACON	kN max	Imax	a	m
HKS-15	150 kN	max. 2-3 mm	25 mm	6.2 kg

Preši pripadaju: • Kalupi za prešanje Ø21,8mm; Ø27,6mm; Ø34,1mm; Ø42,7mm; Ø48,7mm; Ø60,5mm; □32×32mm • Torba za transport

Namijenjena je za opremanje metalnih ormara. Pomoću ovog alata na metalni ormar se mogu montirati signalne svjetiljke, tipkala, sklopke, te brtvene uvodnice za uvođenje kabela.



Dijelovi po narudžbi



TRACON		Imax
HKS-15-20	kabelska uvodnica MG20	Ø20 mm
HKS-15-22	tipkalo Ø22 mm	Ø22 mm
HKS-15-25	kabelska uvodnica MG25	Ø25 mm
HKS-15-32	kabelska uvodnica MG32	Ø32 mm
HKS-15-40	kabelska uvodnica MG40	Ø40 mm
HKS-15-50	kabelska uvodnica MG50	Ø50 mm
HKS-15-63	kabelska uvodnica MG63	Ø63 mm
HKS-15-PG13,5	kabelska uvodnica PG13,5	Ø20 mm
HKS-15-PG16	kabelska uvodnica PG16	Ø23,5 mm
HKS-15-PG21	kabelska uvodnica PG21	Ø29,5 mm
HKS-15-PG29	kabelska uvodnica PG29	Ø36 mm
HKS-15-PG36	kabelska uvodnica PG36	Ø46 mm
HKS-15-PG42	kabelska uvodnica PG42	Ø51 mm
HKS-15-PG48	kabelska uvodnica PG48	Ø59 mm
HKS-15-43×43	instrument za okvir 48×48 mm	□43×43 mm
HKS-15-68×68	instrument za okvir 72×72 mm	□68×68 mm
HKS-15-92×92	instrument za okvir 96×96 mm	□92×92 mm
HKS-15-BSZ10	sajla za uvlačenje, 105 mm	max. 2-3 mm

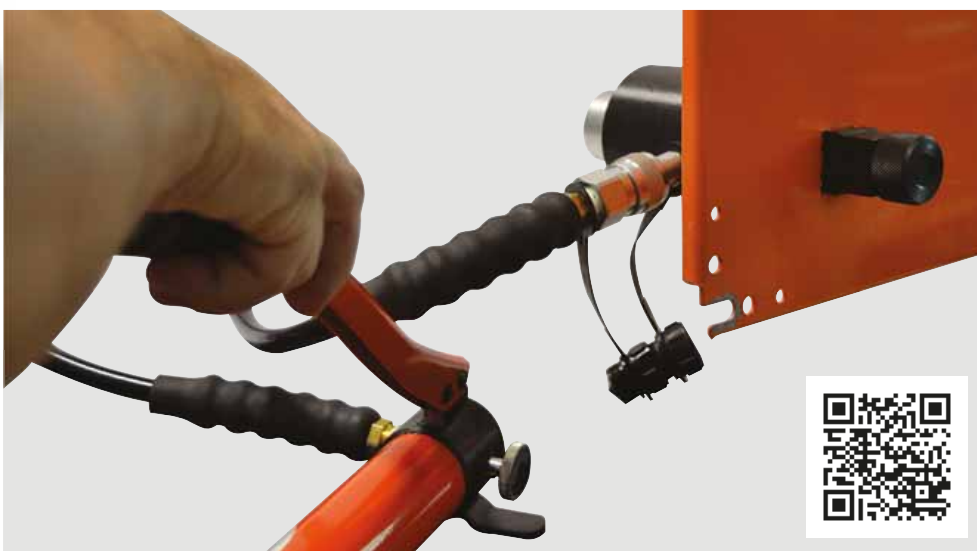

Kliješta s transmisijom za sječenje Cu i Al kabela

TRACON	d _{max} 	NYN 	NYN 	NYCWY 	NAYY 	NAYY 	AYCWY
RKV300	35 mm	max. 4×50	max. 1×240	max. 4×50/25	max. 4×70	max. 1×300	max. 4×50/25
RKV700	60 mm	max. 4×95	max. 1×240	max. 4×95/50	max. 4×120	max. 1×300	max. 4×95/35
RKV1000	95 mm	–	–	max. 4×240/120	max. 4×240	max. 1×500	–



RKV300



RKV700



teleskopska ručka

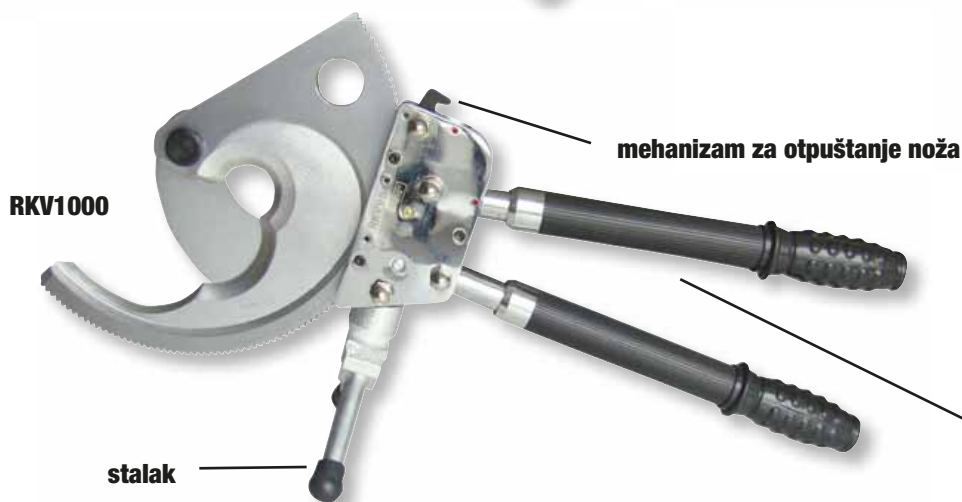

RKV1000

mekhanizam za otpuštanje noža



stalak



teleskopska ručka



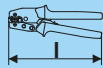

Kliješta za sječenje bakrenog i aluminijskog kabela

TRACON	A_{max}	d_{max}		
CC22	16 mm ²	5,5 mm	150 mm	190 g
CC38	25 mm ²	6,5 mm	210 mm	350 g
CC60	35 mm ²	8 mm	230 mm	510 g
CC80	70 mm ²	9 mm	235 mm	510 g
CC100	100 mm ²	15 mm	320 mm	500 g
CC250	250 mm ²	17 mm	600 mm	1250 g
CC500	500 mm ²	25 mm	800 mm	2850 g

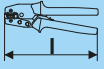

Kliješta izolirana za 1000 V

TRACON			
KF-1000	160 mm	230 g	Kombinirana kliješta
KF-1000-2	200 mm	370 g	Kombinirana kliješta
KB-1000	160 mm	230 g	Kliješta za skidanje izolacije
KC-1000	160 mm	210 g	Sjekaća kliješta
KL-1000	160 mm	230 g	Plosnata kliješta



RELEVANT STANDARD
EN 60900

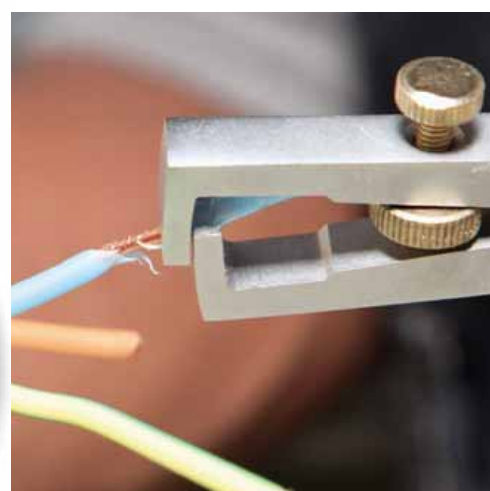

Odvijači izolirani za 1000 V, SD

TRACON



SD375F		3×75 mm
SD4100F		4×100 mm
SD5125F		5×125 mm
SD6100F		6×100 mm
SD6125F		6×125 mm
SD6150F		6×150 mm
SD375S		3×75 mm (PH0)
SD4100S		4×100 mm
SD5125S		5×125 mm (PH1)
SD6100S		6×100 mm (PH2)
SD6125S		6×125 mm (PH2)
SD6150S		6×150 mm (PH2)



RELEVANT STANDARD
EN 60900



Odvijači izolirani za 1000 V, kombi-profil

TRACON



SDDK4100S		4×100 mm
SDDK5125S		5×125 mm (PZ1)
SDDK6150S		6×150 mm (PZ2)



VDE TEST REPORT NO.:
40011797



RELEVANT STANDARD
EN 60900

Odvijači **SDDK** su posebno oblikovani i prilagođeni za specijalno oblikovane vijke u električnim brojilima, automatskim osiguračima i magnetskim sklopkama iz ponude Tracona. Ti vijci su zvjezdastog profila, pogodni za pritezanje i pomoću plosnatog odvijača. Kombi-profil objedinjuje prednosti križnih i plosnatih odvijača, omogućivši lakše i pouzdanije pritezanje.



Set odvijača izoliranih za 1000 V

TRACON





KSET1000	1.0 × 5.5 × 125 mm	PH2 × 100 mm
	0.8 × 4.0 × 100 mm	PH1 × 80 mm
	0.4 × 2.5 × 75 mm	PH0 × 60 mm



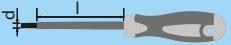

SD odvijači s CrV vrškom

Plosnati (SL) odvijači

TRACON			
SD2575SL	SL 2,5 × 75 mm	CrV	52 g
SD40100SL	SL 4,0 × 100 mm	CrV	58 g
SD55125SL	SL 5,5 × 125 mm	CrV	90 g
SD65150SL	SL 6,5 × 150 mm	CrV	127 g



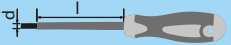

Križni (Phillips, PH) odvijači

TRACON			
SD3060PH0	PH0 3,0 × 60 mm	CrV	49 g
SD5080PH1	PH1 5,0 × 80 mm	CrV	73 g
SD60100PH2	PH2 6,0 × 100 mm	CrV	102 g
SD80150PH3	PH3 8,0 × 150 mm	CrV	178 g



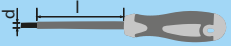

Pozidriv (PZ) odvijači

TRACON			
SD3060PZ0	PZ0 3,0 × 60 mm	CrV	49 g
SD5080PZ1	PZ1 5,0 × 80 mm	CrV	73 g
SD60100PZ2	PZ2 6,0 × 100 mm	CrV	102 g
SD80150PZ3	PZ3 8,0 × 150 mm	CrV	178 g

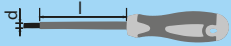

SD odvijači s CrV vrškom

Kombinirani (SLPZ) odvijači

TRACON			
SD5080SLPZ1	SL/PZ1 5,0 × 80 mm	CrV	73 g
SD60100SLPZ2	SL/PZ2 6,0 × 100 mm	CrV	102 g



CrV: →
krom-vanadij

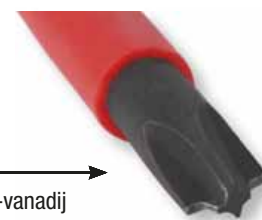



SD5080SLPZ1



SD60100SLPZ2



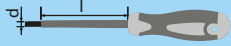

Set od 8 odvijača u kutiji

TRACON			
SDSETOF8			
-	SD2575SL	SL 2,5 × 75 mm	CrV 52 g
-	SD40100SL	SL 4,0 × 100 mm	CrV 58 g
-	SD55125SL	SL 5,5 × 125 mm	CrV 90 g
-	SD65150SL	SL 6,5 × 150 mm	CrV 127 g
-	SD3060PH0	PH0 3,0 × 60 mm	CrV 49 g
-	SD5080PH1	PH1 5,0 × 80 mm	CrV 73 g
-	SD60100PH2	PH2 6,0 × 100 mm	CrV 102 g
-	SD80150PH3	PH3 8,0 × 150 mm	CrV 178 g

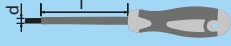

Set od 12 odvijača u kutiji

TRACON			
SDSETOF12			
-	SD2575SL	SL 2,5 × 75 mm	CrV 52 g
-	SD40100SL	SL 4,0 × 100 mm	CrV 58 g
-	SD55125SL	SL 5,5 × 125 mm	CrV 90 g
-	SD65150SL	SL 6,5 × 150 mm	CrV 127 g
-	SD3060PH0	PH0 3,0 × 60 mm	CrV 49 g
-	SD5080PH1	PH1 5,0 × 80 mm	CrV 73 g
-	SD60100PH2	PH2 6,0 × 100 mm	CrV 102 g
-	SD80150PH3	PH3 8,0 × 150 mm	CrV 178 g
-	SD3060PZ0	PZ0 3,0 × 60 mm	CrV 49 g
-	SD5080PZ1	PZ1 5,0 × 80 mm	CrV 73 g
-	SD60100PZ2	PZ2 6,0 × 100 mm	CrV 102 g
-	SD80150PZ3	PZ3 8,0 × 150 mm	CrV 178 g





UČITAJTE ŠIFRU!

- Pogledajte naše novosti
- Budite u tijeku



Naša ponuda se brzo i kontinuirano razvija!
Katalog prikazuje stanje u travnju 2021. godine.
Za aktualne informacije posjetite našu
web stranicu!

Alat za zatezanje i sječenje kablskih vezica

TRACON		
TG007	2.2-8 mm	220 g
TG008	2.2-4.8 mm	320 g



TG008



TG007



Alat za zatezanje i sječenje čeličnih kablskih vezica

TRACON		
TGF	4,6 - 7,9mm	620 g





Užad (sajle) za uvlačenje

TRACON			
TBSZ-5	5 m		Plastično uže za uvlačenje s metalnom glavom i ušicom
TBSZ-10	10 m	∅ = 3 mm	
TBSZ-20	20 m		
TBSZS-5	5 m		Metalno uže za uvlačenje
TBSZS-10	10 m	∅ = 3.2 mm	
TBSZS-20	20 m		
TBSZF-5	5 m		Metalna vrpca za uvlačenje
TBSZF-10	10 m	d = 3.2 mm	
TBSZF-20	20 m		



Fen za vrući zrak

TRACON	U_n				
HLF-02	230 V AC	1.000/2.000 W	350/600 °C	1450 g	300 / 500 l/min



STEZNI PROIZVODI



D/2-D/13

Nož s dvije oštrice za skidanje izolacije

TRACON		
KB-UNI	160 mm	70 g



Alat za skidanje izolacije

TRACON		max. 	
KBY	200 mm	12 mm	95 g













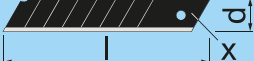

UČITAJTE ŠIFRU!

- Pogledajte naše novosti
- Budite u tijeku

Naša ponuda se brzo i kontinuirano razvija!
 Katalog prikazuje stanje u travnju 2021. godine.
 Za aktualne informacije posjetite našu
 web stranicu!

UTILK Skalpel

TRACON						
UTILK01			168×35×18 mm	l=110; d=18; x=0,7 (×4)	Zn + TPR	250 g
UTILK02			178×33×19 mm	l=110; d=18; x=0,7 (×1)	Zn + TPR	250 g
UTILK03			155×33×19 mm	l=110; d=18; x=0,7 (×1)	ABS + TPR	125 g
UTILK04			175×41×27 mm	l = 62; d=19; x=0,6 (×1)	Al + TPR	194 g
UTILK05			149×19×17 mm	l=90; d=12.5; x=0,2mm; x1	ABS	59 g
UTILK06			140×23×18 mm	l=90; d=12.5; x=0,2mm; x1	Al	80 g
UTILK07			145×22×18 mm	l=82; d=9; x=0,6mm; x1	TPR	54 g
UTILK08			145×21×17 mm	l=82; d=9; x=0,6mm; x1	ABS	50 g

UTILK01
Ručka od cinka,
s gumenim umetkom

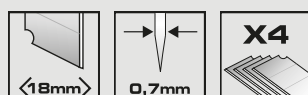

UTILK05
Savrtljiva SK4 oštrica,
opružno pričvrščena, ručka od ABS-a

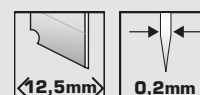

UTILK02
Ručka od legure cinka,
s gumenim umetkom

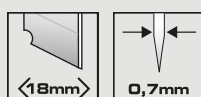

UTILK06
Savrtljiva SK4 oštrica,
fiksno pričvrščena, aluminijaska legura

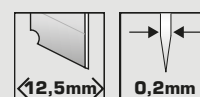

UTILK03
Ručka od ABS-a,
s gumenim umetkom

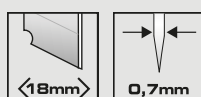

UTILK07
Uska SK4 oštrica, opružno pričvrščena,
s ušicom, ručka od TPR gume

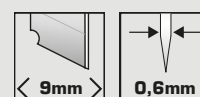

UTILK04
Skalpel s trapeznom oštricom,
alu ručka s gumenim umetkom



UTILK08
Uska SK4 oštrica, opružno pričvrščena,
ručka od ABS-a

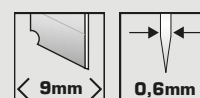

BD Oštrice

TRACON		m
BD02	l=90; d=12,5; x=0,2mm; (×30)	38 g
BD05	l=110; d=18; x=0,5mm; (×10)	105 g
BD06	l=110; d=18; x=0,6mm; (×10)	115 g
BD07	l=110; d=18; x=0,7mm; (×10)	125 g
BDT06	l=62; d=19; x=0,6mm; (×10)	92 g
BD069	l=82; d=9; x=0,6mm; (×10)	38 g

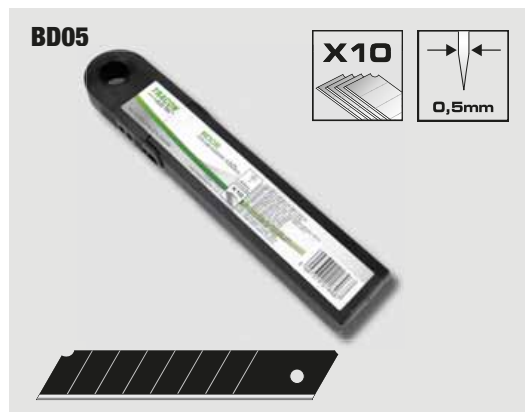

- ekstremno oštra • 5× trajnija od standardne oštrice • nehrđajući čelik
- laserom obrađeni rezni rubovi rezultiraju većim stupnjem tvrdoće
 - za posebno teške zadatke • SK4 alatni čelik



UČITAJTE ŠIFRU!

- Pogledajte naše novosti
- Budite u tijeku

Naša ponuda se brzo i kontinuirano razvija!
Katalog prikazuje stanje u travnju 2021. godine.
Za aktualne informacije posjetite našu
web stranicu!