



Odvodnici prenapona, tip 1+2 **4**



Odvodnici prenapona, tip 2 **5**



Odvodnici prenapona, tip 1+2+3 **6**



Odvodnici prenapona, tip 3 **7**



DC odvodnici prenapona **7**



Odvodnik prenapona tipa 2+3 (za LED pogonske jedinice) **11**



EVOZ automatski osigurači **16**



EVOTDA automatski osigurač **17**



EVOH automatski osigurači za velike struje **18**



EVON automatski osigurači **19**



EVOK kombinirane zaštitne sklopke **20**



EVOV zaštitne strujne sklopke **21**

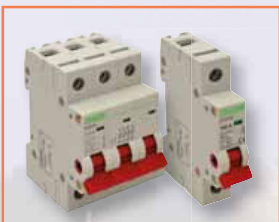

EVOTIK rastavljačke sklopke **23**



EVOSVK izmjenične sklopke za redanje **24**



EVOMS rastavne sklopke za redanje, s lokotom **25**



EVOSLJL signalne svjetiljke **25**



EVOV modularno tipkalo i sklopka **26**



EVOBT sigurnosni transformator (za zvonca) **26**



EVOHK instalacijski sklopnici **27**



Releji za povećani i smanjeni napon s automatskim ponovnim uključivanjem **28**



Automatski osigurači tipa MB **31**



Automatski osigurači tipa TDZ **32**



DC automatski osigurači za istosmjerne električne mreže **33**



Kombinirana zaštitna sklopka tipa KVK **35**



Zaštitne strujne sklopke tipa RB **36**



Zaštitna strujna sklopka s motornim automatom za ponovno uklapanje **39**



Stubišni automat (vremenska sklopka) **41**



Impulsni relej **42**



Signalna zvonca **42**



Priključnice za redanje **43**



Nadžbukna sklopka i utičnica tipa TP-RH **44**



Podžbukna utičnica s USB portom **46**



Bežično zvono **47**



Senzor ugljičnog monoksida **50**



































Bežični senzor dima s mogućnošću dojavljivanja **51**



Piktogrami za zaglavlje tablica

	Napomena i dopuna		Vrijeme premošćivanja (h)		Boja		Duljina strujnog kruga tipkala
	Totalna odvodna moć struje munje	I_n	Nazivna struja (A)		Broj LED (kom.)	IP..	Stupanj zaštite
U_p	Razina naponske zaštite		Odvodna moć struje munje	U_n	Nazivni napon (V)		Nazivna radna struja
I_{cn} EN60698	Nazivna pogonska kratkospojna prekidna moć automatskih osigurača	U_c	Max. stalni pogonski napon	I_{max} 8/20µs	Max. odvodna struja		Dimenzije (LxWxH)
IΔ_n (mA)	Nazivna isklonpa struja greške	I_e	Nazivna pogonska struja	U_m	Nazivni radni napon		Max. presjek vodiča
	Gornja razina naponske zaštite	P_{max}	Nazivna snaga	P_s	Vlastiti utrošak snage		Kontakti
	Broj polova		Donja razina strujne zaštite		Isklonpa karakteristika		Utičnica s poklopcem
	Max. sekundarna struja		Broj modula		Lijevi bok automatskog osigurača		Broj primjenjivih tipkala
	Bočni zaštitni kontakt		Sekundarni napon		Primarni napon		Kuglični ležaj
	Mrežni sustav		Šiljasti zaštitni kontakt		Obična utičnica		Zatvarač protiv refleksa

Piktogrami za tehničke parametre

230 V AC	Nazivni napon (V)		Nazivna frekvencija		Učestalost skapanja/sat	IP 54	Stupanj zaštite
	Jačina zvuka		Relativna vlažnost		Temperatura okoline		Pokazivanje preniskog napona baterije
	Zamjenjivi umetak		Kompaktni		Pomoćni kontakti		Max. presjek vodiča
	Termoosigurač		Iskrište		Varistor		Optička signalizacija
	Preporučeni predosigurač		Razred energetske učinkovitosti	E3	Razred energetske učinkovitosti		Otpor
	Mjerni instrument s LCD pokazivačem		Rasvjetno tijelo sa zaštitom od dodira II. razreda		Za izmjenične mreže		Za mreže s izmjeničnom i pulsirajućom istosmjernom strujom
U_{imp} 6 kV	Nazivni podnosivi udarni napon		Nazivni izolacijski napon		Električni vijek trajanja		Mehanički vijek trajanja
I_{cn} EN60698 10 kA	Nazivna pogonska kratkospojna prekidna moć automatskih osigurača		Rasvjetno tijelo zamontažu na bočni zid	P_m 0,8 W	Vlastiti utrošak snage		Vijek trajanja
	Plombiranje u stanju "0-1-2"		Plombiranje u stanju "OFF"		Udaljenost između kontakata	V0 UL94	Otpornost na vatru po UL 94
	Montiranje na nosač		Montaža na nosače za redanje sa šiljcima		Montaža na nosače za redanje sa šiljcima i/ili viličastim stopicama		Tip okidača: Termički i magnetski

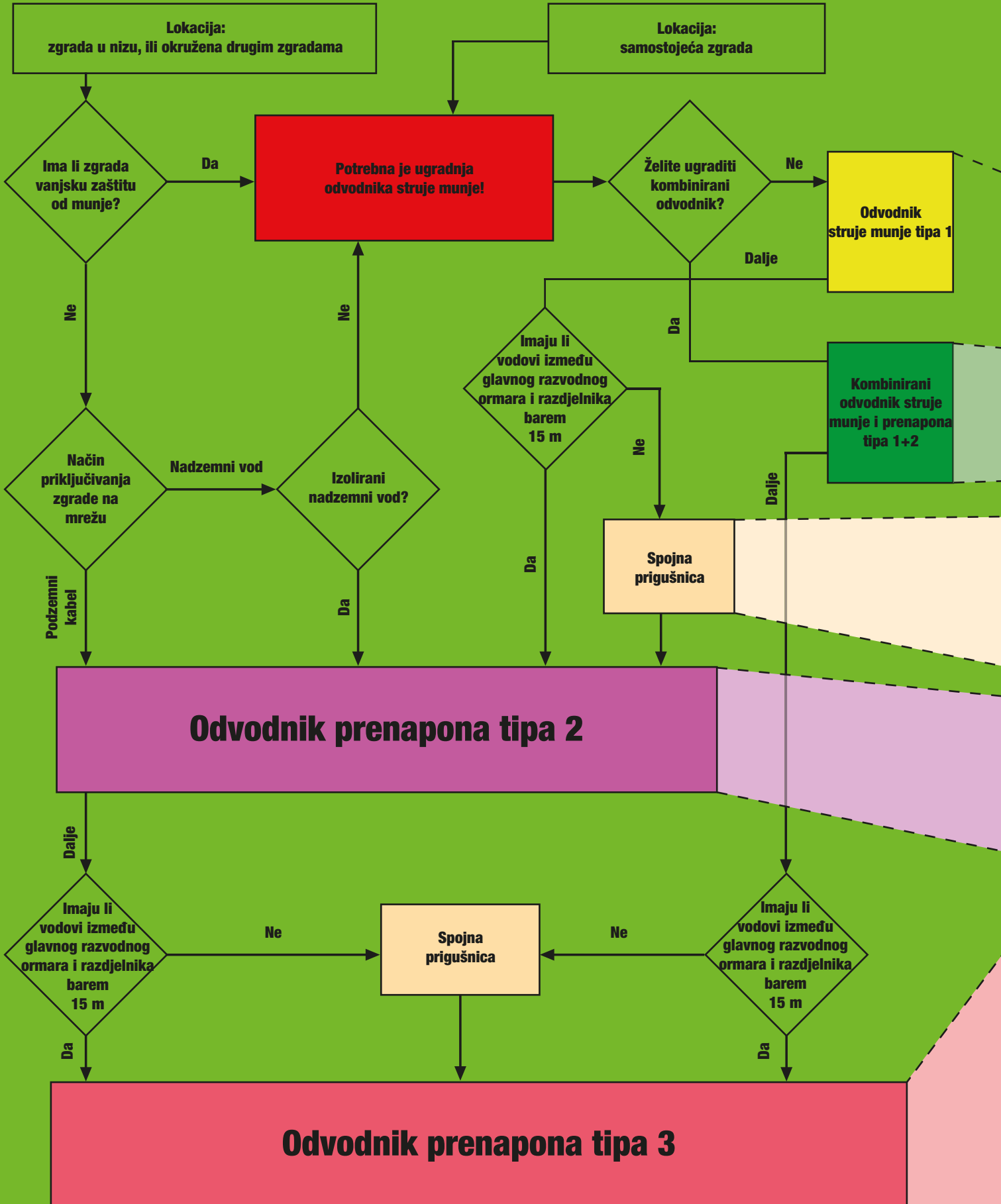

Pomoć pri izboru

Pri projektiranju odgovarajućeg sustava zaštite od munje i prenapona, radi njegove složenosti svakom korisniku preporučujemo izvedbu uz pomoć stručne osobe!

Priloženi dijagram tijekom pruža pomoć pri projektiranju, njegovim praćenjem mogu se izabrati sastavni elementi za zaštitu mreže jake struje.

Dijagram tijekom treba započeti od lokacije (mjesto izgradnje) i uvijek nastaviti do odvodnika tipa 3.

Za minimalnu zaštitu treba ugraditi barem odvodnike tipa 2 i 3!

Općenito, mjesto ugradnje za odvodnike tipa 1 i 1+2 je glavni razvodni ormar, a za ugradnju odvodnika tipa 2 i 3 preporučujemo podrazdjelnike.

Ukoliko je duljina voda napajanja između odvodnika tipa 3 i štitičenog uređaja veća od 30 m kod priključka uređaja zaštitu tipa 3 treba ponoviti!

Za zaštitu sustava slabe struje preporučujemo produžne priključnice s prenaponskom zaštitom.

Detaljniji opis u DODATKU.

DC odvodnici prenapona



F/7

Odvodnici prenapona, tip 1+2



F/4

Odvodnici prenapona, tip 1+2+3



F/6

Spojna prigušnica



F/11

Odvodnici prenapona, tip 2



F/5

Odvodnici prenapona, tip 3



F/7

Odvodnici prenapona, tip 2+3



F/6

Višestruke priključnice sa zaštitom



G/11-G/12

Odvodnici prenapona, tip 1+2

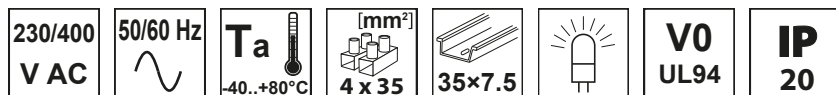

TRACON	xP	U _c	I _{imp} L-N/(N-PE)1P 10/350µs	I _n L-N/(N-PE) 8/20µs	I _{max} 8/20µs	U _p L-N/(N-PE)	gG	W (mm)
ESPD1+2-50-1P	1P	385 V AC	50 kA	50 kA	160 kA	≤ 2,5 kV	500 A	TN 36
ESPD1+2-50-2P	2P	385 V AC	50 kA	50 kA	160 kA	≤ 2,5 kV		TN 72
ESPD1+2-50-3P	3P	385 V AC	50 kA	50 kA	160 kA	≤ 2,5 kV		TN-C 108
ESPD1+2-50-4P	4P	385 V AC	50 kA	50 kA	160 kA	≤ 2,5 kV		TN-S 144
ESPD1+2-50-1+1P	1+1P	385 V AC	50 kA / 100 kA	50 kA / 100 kA	160 kA / 200 kA	≤ 2,5 kV		TN, TT 72
ESPD1+2-50-3+1P	3+1P	385 V AC	50 kA / 100 kA	50 kA / 100 kA	160 kA / 200 kA	≤ 2,5 kV		TN-S, TT 144
ESPD1+2-12.5-1P	1P	275 V AC	12,5 kA	20 kA	50 kA	≤ 1,3 kV	160 A	TN 18
ESPD1+2-12.5-2P	2P	275 V AC	12,5 kA	20 kA	50 kA	≤ 1,3 kV		TN 36
ESPD1+2-12.5-3P	3P	275 V AC	12,5 kA	20 kA	50 kA	≤ 1,3 kV		TN-C 54
ESPD1+2-12.5-4P	4P	275 V AC	12,5 kA	20 kA	50 kA	≤ 1,3 kV		TN-S 72
ESPD1+2-12.5-1+1P	1+1P	275 V AC	12,5 kA	20 kA / 40 kA	50 kA / 70 kA	≤ 1,3 kV / 1,5 kV		TN, TT 36
ESPD1+2-12.5-3+1P	3+1P	275 V AC	12,5 kA	20 kA / 40 kA	50 kA / 70 kA	≤ 1,3 kV / 1,5 kV		TN-S, TT 72
ESPD1+2-12.5M*	1P	275 V AC	12,5 kA	20 kA	50 kA	≤ 1,3 kV	TN 18	
ESPD1+2-12.5NPE*	+1P	275 V AC	12,5 kA	40 kA	70 kA	≤ 1,5 kV	TN, TT 18	

* zamjenjivi ulošci

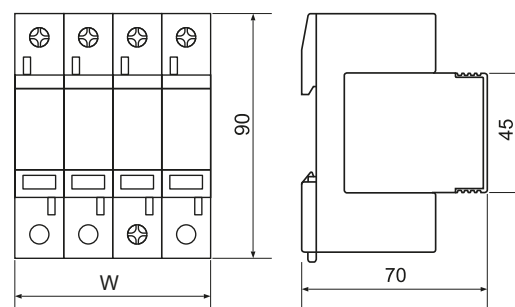
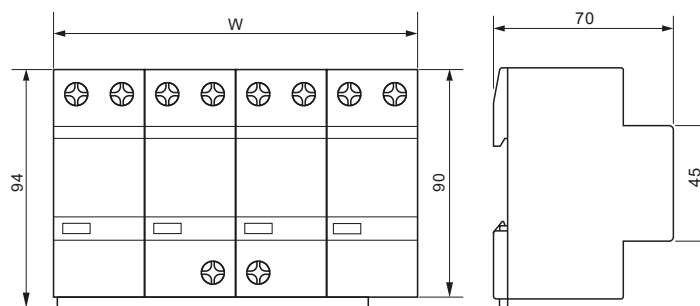

UČITAJTE ŠIFRU!

- Pogledajte naše novosti
- Budite u tijeku

**Naša ponuda se brzo i kontinuirano razvija!
Katalog prikazuje stanje u travnju 2021. godine.
Za aktualne informacije posjetite našu
web stranicu!**

Odvodnici prenapona, tip 2

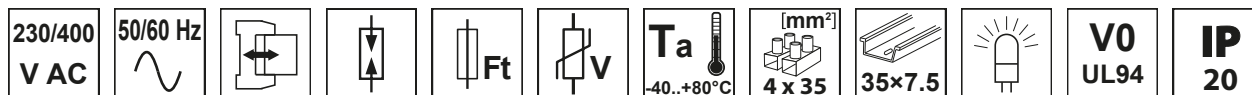

TRACON	$\times P$ 1P 2P 3P 4P	U_c	I_n L-N/(N-PE) 8/20 μ s	I_{max} 8/20 μ s	U_p L-N/(N-PE)	gG	W (mm)
ESPD2-40-1P	1P	275 V AC	20 kA	40 kA	$\leq 1,3$ kV	125 A	TN 18
ESPD2-40-2P	2P	275 V AC	20 kA	40 kA	$\leq 1,3$ kV		TN 36
ESPD2-40-3P	3P	275 V AC	20 kA	40 kA	$\leq 1,3$ kV		TN-C 54
ESPD2-40-4P	4P	275 V AC	20 kA	40 kA	$\leq 1,3$ kV		TN-S 72
ESPD2-40-1+1P	1+1P	275 / 255 V AC	20 kA	40 kA	$\leq 1,3$ kV / 1,5 kV		TN, TT 36
ESPD2-40-3+1P	3+1P	275 / 255 V AC	20 kA	40 kA	$\leq 1,3$ kV / 1,5 kV		TN-S, TT 72
ESPD2-40M*	1P	275 V AC	20 kA	40 kA	$\leq 1,3$ kV	200 A	TN 18
ESPD2-40NPE*	+1P	255 V AC	20 kA	40 kA	$\leq 1,5$ kV		TN, TT 18
ESPD2-70-1P	1P	275 V AC	40 kA	70 kA	$\leq 1,7$ kV		TN 18
ESPD2-70-2P	2P	275 V AC	40 kA	70 kA	$\leq 1,7$ kV		TN 36
ESPD2-70-3P	3P	275 V AC	40 kA	70 kA	$\leq 1,7$ kV		TN-C 54
ESPD2-70-4P	4P	275 V AC	40 kA	70 kA	$\leq 1,7$ kV		TN-S 72
ESPD2-70-1+1P	1+1P	275 / 255 V AC	40 kA	70 kA	$\leq 1,7$ kV / 1,5 kV	200 A	TN, TT 36
ESPD2-70-3+1P	3+1P	275 / 255 V AC	40 kA	70 kA	$\leq 1,7$ kV / 1,5 kV		TN-S, TT 72
ESPD2-70M*	1P	275 V AC	40 kA	70 kA	$\leq 1,7$ kV		TN 18
ESPD2-70NPE*	+1P	255 V AC	40 kA	70 kA	$\leq 1,5$ kV		TN, TT 18

* zamjenjivi ulošci

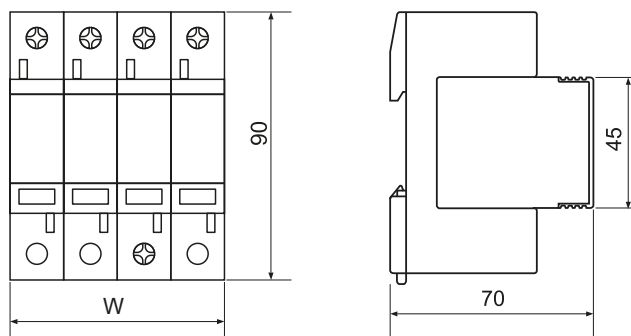

UČITAJTE ŠIFRU!

- Pogledajte naše novosti
- Budite u tijeku

Naša ponuda se brzo i kontinuirano razvija!
 Katalog prikazuje stanje u travnju 2021. godine.
 Za aktualne informacije posjetite našu
 web stranicu!

Odvodnici prenapona, tip 2+3

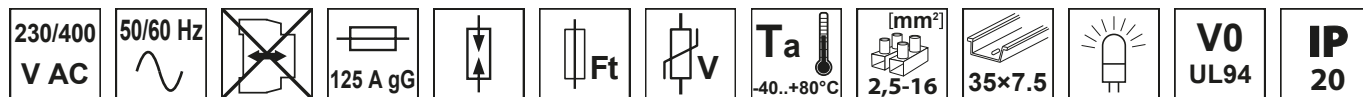

TRACON	xP	U _c	I _n L-N/(N-PE) 8/20µs	I _{max} 8/20µs	U _{oc}	U _p L-N/(N-PE)		W (mm)
ESPD2+3-40-2P	2P	275 V AC	20 kA	40 kA	10 kV	≤ 1,3 kV	TN	18
ESPD2+3-40-4P	4P	275 V AC	20 kA	40 kA	10 kV	≤ 1,3 kV	TN-S	36
ESPD2+3-40-1+1P	1+1P	275 V AC	20 kA	40 kA	10 kV	≤ 1,3 kV / 1,5 kV	TN, TT	18
ESPD2+3-40-3+1P	3+1P	275 V AC	20 kA	40 kA	10 kV	≤ 1,3 kV / 1,5 kV	TN-S, TT	36

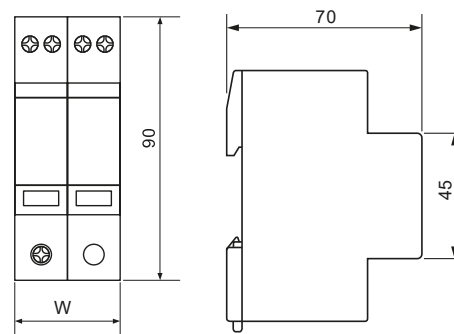

Odvodnici prenapona, tip 1+2+3

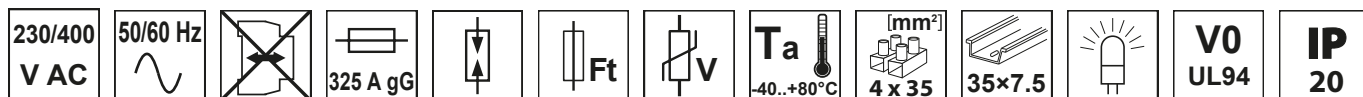

TRACON	xP	U _c	I _{imp} L-N/(N-PE)1P 10/350µs	I _n L-N/(N-PE) 8/20µs	I _{max} 8/20µs	U _{oc}	U _p L-N/(N-PE)		W (mm)
ESPD1+2+3-25-1P	1P	275 V AC	25 kA	25 kA	100 kA	20 kV	≤ 1,3 kV	TN	36
ESPD1+2+3-25-2P	2P	275 V AC	25 kA	25 kA	100 kA	20 kV	≤ 1,3 kV	TN	72
ESPD1+2+3-25-3P	3P	275 V AC	25 kA	25 kA	100 kA	20 kV	≤ 1,3 kV	TN-C	108
ESPD1+2+3-25-4P	4P	275 V AC	25 kA	25 kA	100 kA	20 kV	≤ 1,3 kV	TN-S	144
ESPD1+2+3-25-1+1P	1+1P	275 V AC	25 kA / 100 kA	25 kA / 100 kA	100 kA	20 kV	≤ 1,3 kV / 1,5 kV	TN, TT	72
ESPD1+2+3-25-3+1P	3+1P	275 V AC	25 kA / 100 kA	25 kA / 100 kA	100 kA	20 kV	≤ 1,3 kV / 1,5 kV	TN-S, TT	144

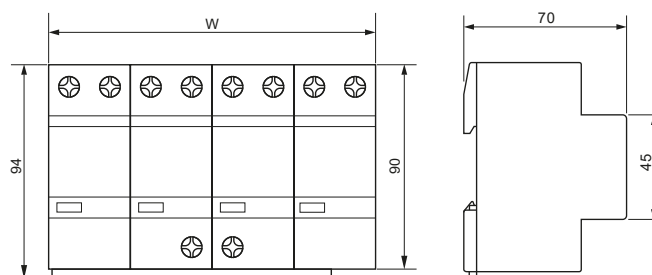

Odvodnici prenapona, tip 3

230 V AC
50/60 Hz

Ta -40...+80°C
V0 UL94
IP 20

Piktogrami
F/0

TRACON	xP	U _n	U _c	I _n L-N/(N-PE) 8/20µs	I _{max} 8/20µs	U _{oc}	U _p	gG		W (mm)
ESPD3-3-2P	1+1P	230 V AC	275 V AC	3 kA	6 kA	6 kV	≤ 1,2 kV	16 A	TN, TT	36×24×15
ESPD3-5-1+1P	1+1P	230 V AC	275 V AC	5 kA	10 kA	10 kV	≤ 1,1 kV	32 A	TN, TT	18
ESPD3-5-2P	2P	230 V AC	275 V AC	5 kA	10 kA	10 kV	≤ 1,1 kV	32 A	TN	18
ESPD3-10-1+1P	1+1P	230 V AC	275 V AC	10 kA	20 kA	20 kV	≤ 1,2 kV	63 A	TN, TT	18
ESPD3-10-2P	2P	230 V AC	275 V AC	10 kA	20 kA	20 kV	≤ 1,2 kV	63 A	TN	18

[mm²]

1,5-4

[mm²]

2,5-16

DC odvodnici prenapona

600/1000 V DC

Ta -40...+80°C
[mm²]

4 x 35

35×7.5

V0 UL94
IP 20



TRACON	xP	U _n	U _c	gG	I _{imp} L-N/(N-PE)1P 10/350µs	I _n L-N/(N-PE) 8/20µs	I _{max} 8/20µs	U _p	W (mm)
ESPD1+2-DC50-600	3P	600 V DC	800 V DC	200 A	12,5 kA	20 kA	50 kA	≤ 3 kV	72
ESPD1+2-DC50-1000	3P	1.000 V DC	1.200 V DC		12,5 kA	20 kA	50 kA	≤ 4 kV	72
ESPD2-DC40-600	3P	600 V DC	800 V DC	125 A	—	20 kA	40 kA	≤ 3 kV	72
ESPD2-DC40-1000	3P	1.000 V DC	1.200 V DC		—	20 kA	40 kA	≤ 4 kV	72
ESPD2-DC40-600V*		600 V DC	800 V DC		—	20 kA	40 kA	≤ 3 kV	18
ESPD2-DC40-600VG*		600 V DC	800 V DC		—	20 kA	40 kA	≤ 3 kV	18
ESPD2-DC40-1000V*		1.000 V DC	1.200 V DC		—	20 kA	40 kA	≤ 4 kV	18
ESPD2-DC40-1000VG*		1.000 V DC	1.200 V DC		—	20 kA	40 kA	≤ 4 kV	18

* zamjenjivi ulošci

Kombinirani odvodnici prenapona (tipa 1+2)

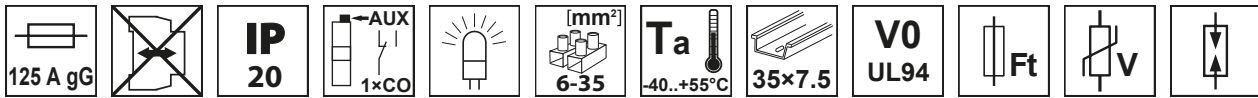

TRACON	xP	I _{imp} 1P 10/350µs	I _{max} 8/20µs	U _n	U _p	U _c	W (mm)	
TTV1+2-100-1P	1P	8 kA	100 kA	230/400 V, 50 Hz	2,2 kV	385 V AC, 500 V DC	27	TN, TT, IT
TTV1+2-100-2P	2P	8 kA	100 kA				54	TN, TT, IT
TTV1+2-100-3P	3P	8 kA	100 kA				81	TN, TT, IT
TTV1+2-100-4P	4P	8 kA	100 kA				108	TN, TT, IT
TTV1+2-100-3P+N/PE	3P+N/PE	8 kA	100 kA				108	TN, TT, IT
TTV1+2-80-1P	1P	8 kA	80 kA		2,2 kV	385 V AC, 500 V DC	27	TN, TT, IT
TTV1+2-80-2P	2P	8 kA	80 kA				54	TN, TT, IT
TTV1+2-80-3P	3P	8 kA	80 kA				81	TN, TT, IT
TTV1+2-80-4P	4P	8 kA	80 kA				108	TN, TT, IT
TTV1+2-80-3P+N/PE	3P+N/PE	8 kA	80 kA				108	TN, TT, IT

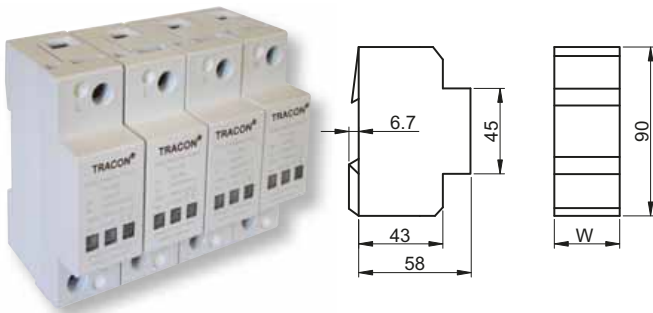

Ovi aparati su u 3-faznim ili 1-faznim mrežama napajanja prikladni za odvođenje udarnih struja velike energije (valnog oblika 10/350 µs) koje mogu nastati tijekom udara munje i/ili prenapona uslijed nadstruja nastalih pri sklapanju (valnog oblika 8/20 µs). Izvedeni su kompaktno. Odvodnici tipa 1+2 ugrađuju se iza prve naprave za zaštitu od kratkog spoja, neposredno iza električnog brojila (u glavni razvodni ormar).

Pozor! Odvodna sposobnost kombiniranih aparata općenito ne dostiže razinu samostalnih stupnjeva!
Uz odgovarajuće dimenzioniranje mogu se primijenjivati i u fotovoltnim (DC) sustavima!

Pomoć pri odabiru vidi na strani F/2-3!

DC odvodnici prenapona tipa 2

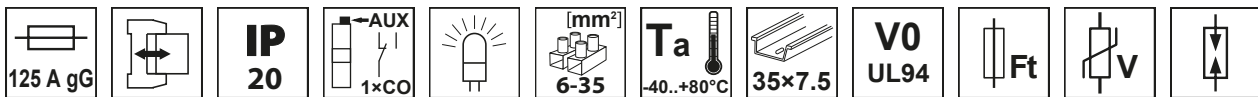

TRACON	xP	U _n	U _p	U _c	I _n L-N 8/20µs	I _{max} 8/20µs
TTV2-40-DC-600	3P	600 V DC	3 kV	800 V DC	20 kA	40 kA
TTV2-40-DC-1000	3P	1000 V DC	4 kV	1200 V DC	20 kA	40 kA



Ulošci

TRACON	I _n L-N 8/20µs	I _{max} 8/20µs	U _p
TTV2-40-DC-600-M	20 kA	40 kA	3 kV
TTV2-40-DC-1000-M	20 kA	40 kA	4 kV
TTV2-40-DC-600-V	20 kA	40 kA	3 kV
TTV2-40-DC-1000-V	20 kA	40 kA	4 kV
TTV2-40-DC-600-G	20 kA	40 kA	3 kV
TTV2-40-DC-1000-G	20 kA	40 kA	4 kV

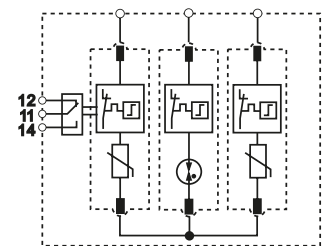
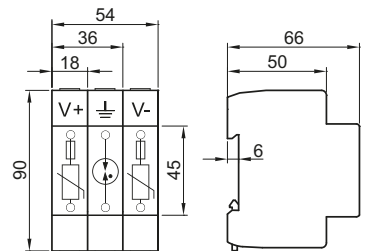

RELEVANT STANDARD
EN 61643

Ovi aparati su prikladni za odvođenje prenapona nastalih uslijed nadstruja pri sklapanju (valnog oblika 8/20 µs). DC odvodnici prenapona su izričito namijenjeni za istosmjerne strujne krugove solarnih (PV) sustava. Izvedeni su kao zamjenjivi moduli. Pomoćni kontakt je ugrađen u podnožje.

Odvodnici prenapona tipa 2

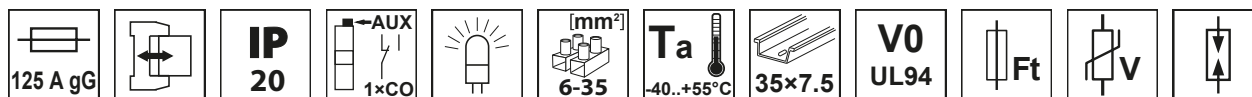

TRACON	xP	I _n L-N 8/20μs	I _{max} 8/20μs	U _n	U _p	U _c	W (mm)	
TTV2-60-1P	1P	30 kA	60 kA	230 V, 3×230/400 V	2,0 kV	385 V AC	18	TN, TT, IT
TTV2-60-2P	2P	30 kA	60 kA				36	TN, TT, IT
TTV2-60-3P	3P	30 kA	60 kA				54	TN, TT, IT
TTV2-60-3P+N/PE	3P+N/PE	30 kA	60 kA				72	TN, TT, IT
TTV2-60-4P	4P	30 kA	60 kA				72	TN, TT, IT
TTV2-40-1P	1P	20 kA	40 kA				18	TN, TT, IT
TTV2-40-2P	2P	20 kA	40 kA		36	TN, TT, IT		
TTV2-40-3P	3P	20 kA	40 kA		54	TN, TT, IT		
TTV2-40-3P+N/PE	3P+N/PE	20 kA	40 kA		72	TN, TT, IT		
TTV2-40-4P	4P	20 kA	40 kA		72	TN, TT, IT		
TTV2-30-1P+N/PE*	1P+N/PE	15 kA	30 kA		1,5 kV	320 V AC	18	TN, TT, IT
TTV2-30-3P+N/PE**	3P+N/PE	15 kA	30 kA		36	TN, TT, IT		
TTV2-20-1P	1P	10 kA	20 kA	1,5 kV	385 V AC	18	TN, TT, IT	
TTV2-20-2P	2P	10 kA	20 kA			36	TN, TT, IT	
TTV2-20-3P	3P	10 kA	20 kA			54	TN, TT, IT	
TTV2-20-3P+N/PE	3P+N/PE	10 kA	20 kA			72	TN, TT, IT	
TTV2-20-4P	4P	10 kA	20 kA			72	TN, TT, IT	

* 2 odvodnika u aparatu širine jednog modula za 1-fazne mreže tipa TNC-S i TNS

** 4 odvodnika u aparatu širine dva modula za 3-fazne mreže tipa TNC-S i TNS

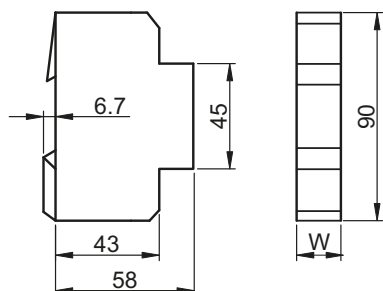

Ovi aparati su prikladni za odvođenje prenapona uslijed nadstruja nastalih pri sklapanju (valnog oblika 8/20 μs).

Odvodnike tipa 2 treba ugraditi u razvodne ormare iza glavnog razvodnog ormara u distribucijske mreže koje sadrže i odvodnike tipa 1 (u zgradama s više stanova u razvodne ormare stanova).

Radi odgovarajućeg rada između odvodnika tipa 1 i tipa 2 moraju se primijeniti vodiči barem 10 – 15 m ili spojna prigušnica. Pomoćni kontakt je ugrađen u osnovu.

Podnožja + Ulošci

TRACON	I _n L-N 8/20μs	I _{max} 8/20μs	W (mm)	TTV2-BASE-2P	TTV2-BASE-3P	TTV2-BASE-4P
TTV2-60-M	30 kA	60 kA	18	OK	OK	OK
TTV2-40-M	20 kA	40 kA	18	-	-	-
TTV2-30-A-M*	15 kA	30 kA	18	-	-	-
TTV2-30-B-M**	15 kA	30 kA	18	-	-	-
TTV2-20-M	10 kA	20 kA	18	-	-	-
TTV2-40-N/PE-M	20 kA	40 kA	18	OK	OK	OK

*2P uložak za aparat TTV2-30-3P+N/PE

**1P+N/PE uložak za aparate TTV2-30-1P+N/PE ili TTV2-30-3P+N/PE



TTV2-20-M

TTV2-40-N/PE-M

Odvodnici prenapona tipa 3 (fina zaštita), redajuća izvedba

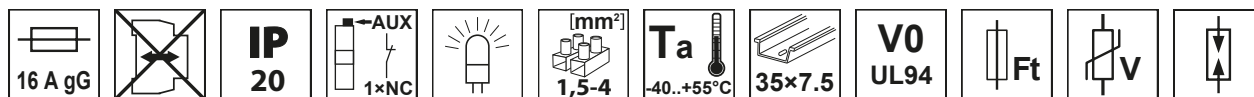

TRACON	xP	I _n L-N 8/20μs	I _{max} 8/20μs	U _n	U _p	U _c	W (mm)	
TTV3-10-1P+N/PE	1P+N/PE	5 kA	10 kA	230 V, 50 Hz; 1~	1,5 kV	385/440 V	36	TN, TT
TTV3-10-3P+N/PE	3P+N/PE	5 kA	10 kA	3×230/400 V, 50 Hz; 3~			72	TN, IT



RELEVANT STANDARD
EN 61643

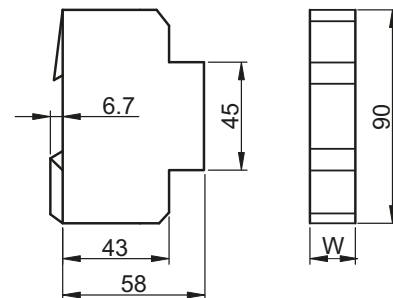

Odvodnike tipa 3 treba postaviti na najmanju moguću udaljenost od šticenog uređaja. To su sekundarne jedinice za zaštitu od munje koje ujedno ograničavaju i vršne vrijednosti napona nastalih uslijed sklapanja u mreži, te sprječavaju da kroz vodiče napajanja prenaponske smetnje dopru u elektroničke uređaje i u njima izazovu kvarove. Izvedeni su kompaktno.

Pozor! Samostalno, kao jedini zaštitni aparati nisu međutim dostatni za rješavanje zaštite uređaja od prenapona!

1- i 3-fazne izvedbe, prikladne za montažu u razvodne kutije mogu se priključiti paralelno ili serijski sa šticehim uređajem. U slučaju rednog spajanja zaštitni aparat treba ugraditi iza nadstrujne zaštite.

KVALITETA

I SIGURNOST

Odvodnici prenapona tipa 3 (fina zaštita), ugradbena izvedba

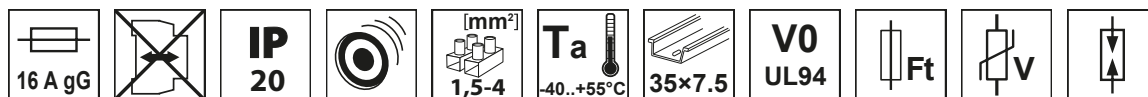

TRACON	$\times P$ 1P2P 1P 2P	I_n L-N 8/20 μ s	I_{max} 8/20 μ s	U_n	U_p	U_c	Terminal Diagram
TTV3-5-1P+N-PE	1P+N-PE	2,5 kA	5 kA	230 V, 50 Hz; 1~	1,25 kV	255 V AC	TN, IT

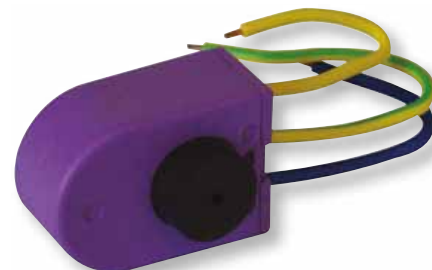
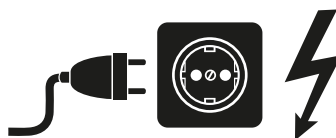
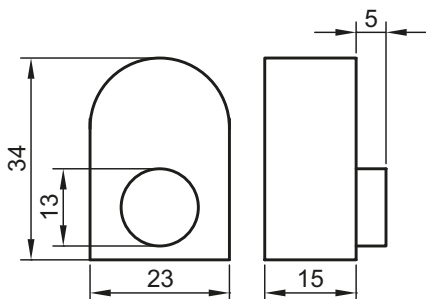

Odvodnike tipa 3 treba postaviti na najmanju moguću udaljenost od šticeg uređaja. To su sekundarne jedinice za zaštitu od munje koje ujedno ograničavaju i vršne vrijednosti napona nastalih uslijed sklapanja u mreži, te sprječavaju da kroz vodiče napajanja prenaponske smetnje dopru u elektroničke uređaje i u njima izazovu kvarove. Izvedeni su kompaktno.

Pozor! Samostalno, kao jedini zaštitni aparati nisu međutim dostatni za rješavanje zaštite uređaja od prenapona!

Odvodnik prenapona tipa 2+3 (za LED pogonske jedinice)

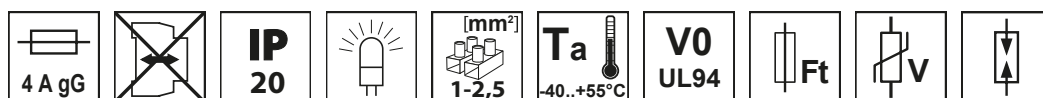

TRACON	I_n L-N 8/20 μ s	I_{max} 8/20 μ s	U_n	U_p	U_c	Terminal Diagram
TTVL2+3-10	5 kA	10 kA	230 V, 50 Hz	1,5 kV	320 V AC	TN, IT



Kompaktni odvodnik prenapona TTVL2+3-10 je namijenjen za zaštitu LED pogonskih jedinica. Jednofazne pogonske jedinice 120-277 VAC štiti od atmosferskih prenapona (uslijed udara munje) ili prijelaznih pojava (tranzijenata).

Njegovu neispravnost označava upaljena signalna svjetiljka na jedinici.

Za zaštitu LSJA i LSJB (E/16-17) uličnih rasvjetnih tijela od prenapona uslijed udara munje.

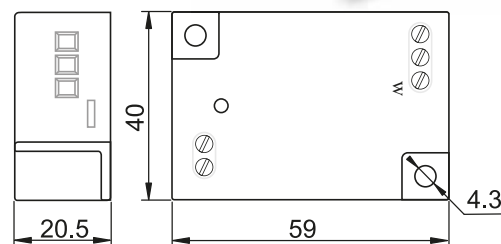

Spojna prigušnica

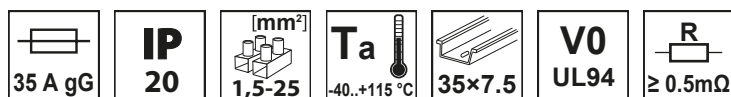

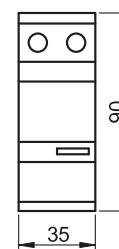
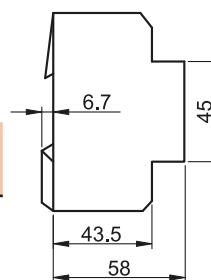

TRACON	$\times 17.5$ 2	I_n	U_n	L
TTV-CSF35	2	35 A	500 V AC/DC	18 μ H \pm 10 %



Osnovni uvjet za koordinirani redosljed rada odvodnika struje munje tipa 1 i odvodnika prenapona tipa 2, koji u kompleksnom sustavu prenaponske zaštite slijedi iza njega, jeste stvaranje naponske razlike između stupnjeva, radi čega se ugrađuje impedancija odgovarajućeg iznosa. Taj se uvjet ispuni općenito, ako se između dva zaštitna aparata nalazi vodič duljine barem 10 – 15 metara.



Automatski osigurači (instalacijski prekidači)

TRACON			I_n	I_{cn} EN60698	
EVON	C	1+N	6 – 32 A	4,5 kA	F/19
EVOZ	B, C	1, 2, 3, 4	1 – 63 A	6 kA	F/16
EVOTDA	B, C	1, 2, 3, 4	1 – 63 A	10 kA	F/17
EVOH	C	1, 2, 3, 4	63 – 125 A	10 kA	F/18
DPN	C	1+N	6 – 32 A	4,5 kA	F/30
MB	B, C	1, 2, 3	6 – 63 A	4,5 kA	F/31
TDZ	B, C, D	1, 2, 3, 4	1 – 63 A	6 kA	F/32
DC	C	1, 2, 3, 4	6 – 63 A	6/10 kA	F/33
KMH	C	1, 2, 3, 4	63 – 125 A	6 kA	F/34

Automatski osigurači su namijenjeni za zaštitu električnih instalacija od preopterećenja i za sprječavanje kvarova uslijed kratkog spoja, odnosno za zaštitu okoliša i sprječavanje nesreća. Isklapati se mogu pomoću bimetalnog termičkog okidača (u slučaju preopterećenja), ili elektromagnetskog brzog okidača (u slučaju kratkog spoja), te ručno. Pri višepolnim izvedbama svi polovi djeluju istodobno.

Isklopne karakteristike

Standardi EN 60898 određuju funkcionalne značajke, zahtjeve prema obliku i konstrukciji, te redoslijed ispitivanja.

Automatski osigurači svih triju karakteristika (B, C, D) u području preopterećenja ($< 2,55 \times I_n$) djeluju jednako. Razlika je u području nadstruja višim od $3 \times I_n$, u kojem automatski osigurači tipa B okidaju pri $3 \dots 5 \times I_n$, tipa C pri $5 \dots 10 \times I_n$, a tipa D pri $10 \dots 15 \times I_n$.

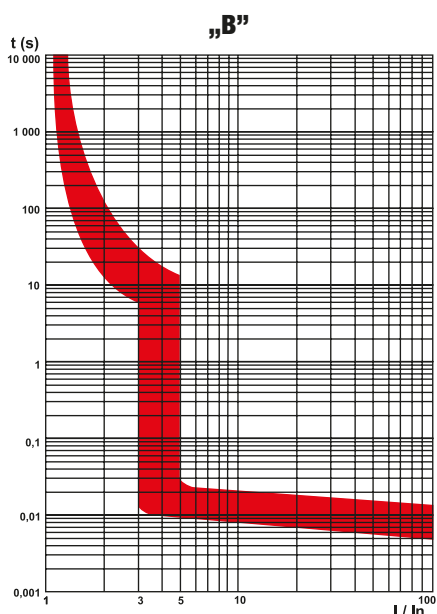

za opću namjenu – za trošila, vodove, strujne krugove sa žaruljama

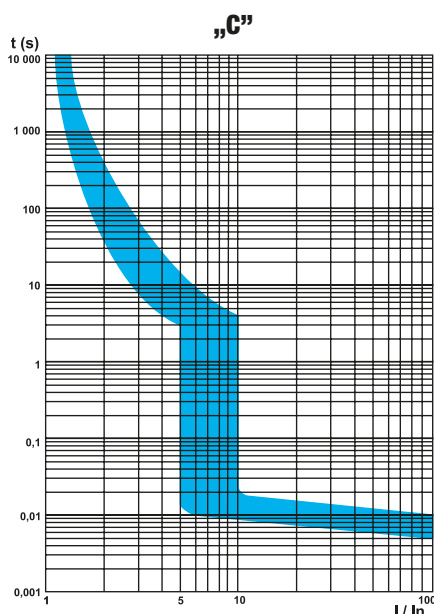

za opću namjenu – za kućanske aparate i naprave, manje i slabije motore

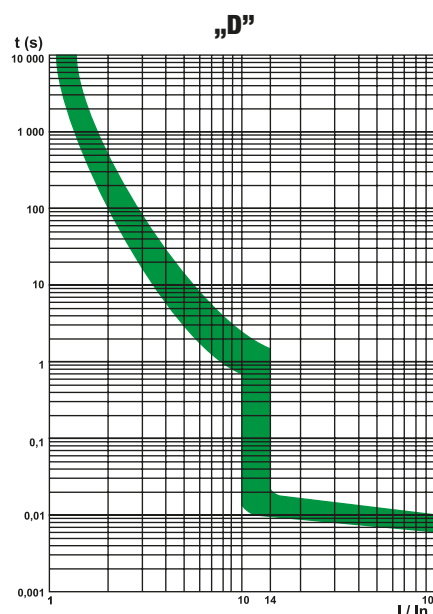

za velike i jake motore, transformatore

Temperaturno ovisni parametri

Dopuštena maksimalna struja opterećenja automatskih osigurača smanjuje se pri povećanoj temperaturi okoline. Ukoliko u razvodni ormar postavimo više automatskih osigurača neposredno jedan do drugoga, pri izboru vrste prekidača moramo uzeti u obzir i rast temperature u unutrašnjosti ormara.





Primjerice, ako maksimalno strujno opterećenje malog prekidača s nazivnom strujom 16A pri 20 °C može biti 17,9A, na 40 °C iznosi točno koliko i nazivna struja tj. 16A, a pri 60 °C samo 13,9A.

Referentna pogonska temperatura automatskih osigurača iznosi 40 °C.

Dopuštena maksimalna struja opterećenja (A)

I_n (A)	20 °C	30 °C	40 °C	50 °C	60 °C
2	2.18	2.08	2	1.9	1.8
4	4.52	4.24	4	3.72	3.44
6	6.48	6.24	6	5.76	5.46
10	11.4	10.7	10	9.2	8.4
16	17.9	16.9	16	15	13.9
20	22.2	21.2	20	18.8	17.6
25	27.7	26.5	25	23.5	21.7
32	35.2	33.6	32	30.4	28.4
40	44.4	42.4	40	37.5	34.8
50	56	53	50	46.5	43
63	71.8	67.4	63	57.9	52.9

Kombinirane zaštitne sklopke





TRACON		xP 	x17.5 	I_n (A)	I_{cn} EN60698	
EVOKE	B, C	2	1	6 – 32 A	6 kA	F/19
EVOK	B, C	2	2	6 – 40 A	4.5 kA	F/20
EVOKM	B, C	2	2	6 – 63 A	6 kA	F/20
KVKVE	B, C	2	1	6 – 32 A	6 kA	F/35
KVK	B, C	2	2	6 – 32 A	3 kA	F/35
KVKM	B, C	2	2	6 – 40 A	6 kA	F/36

Kombinirana zaštitna sklopka je namijenjena prvenstveno za elektroinstalacije u zgradama: za zaštitu ljudi od strujnog udara, zaštitu od preopterećenja i zaštitu od kratkog spoja. Posebno je prikladna za strujne krugove u prostorijama u kojima se želi postići povećana sigurnost (dječja soba, bolničke prostorije, itd.). Za obavljanje sve tri funkcije u jednom zajedničkom kućištu se nalaze strujni transformator zaštitne strujne sklopke, brzi magnetski okidač i bimetalni termički nadstrujni okidač. Strujni krug štice nog trošila prekida jed-nopolno. Ima optički indikator koji crvenom bojom označava uklopljeno stanje aparata. Strujno-zaštitna funkcionalnost aparata se provjerava pritiskom na probnu tipku „T”. Kontrolu je potrebno izvoditi po mogućnosti barem jednom mjesečno.

Zbog prilagođenih dimenzija, u slučaju naknadnih promjena, moguće ju je jednostavno ugraditi na mjesto postojećeg aparata za zaštitu (automatski osigurač).



Zaštitne strujne sklopke (FID sklopke)

TRACON		xP 	I_n (A)	$I_{\Delta n}$ (mA)	I_{cn} EN60698	
EVOV		2, 4	25, 40, 63, 80	30, 100, 300	6 kA	F/21
RB		2, 4	25, 40, 63	30, 100, 300, 500	4,5 kA	F/36
TFV		2, 4	16, 25, 40, 63	30, 100, 300	6 kA	F/37
TFVH		4	80, 100	30, 100, 300	6 kA	F/37
EVOG		2, 4	25, 40, 63, 80	30, 100, 300	6 kA	F/22
TFG		2, 4	16, 25, 40, 63	30, 100, 300	6 kA	F/38
TFGA		–	16	30	6 kA	F/38
TFIG		2, 4	16, 25, 40, 63, 80	30, 100, 300	10 kA	F/39

TRACON	Naziv	EVOV	EVOG	RB	TFV	TFVH	TFG	TFIG
EDS-□, EDFK-□	razvodni ormari	✓	✓	✓	✓	✓	✓	✓
TFSS-□	redni nosači	✓	✓	✓	✓	✓	✓	✓
TFSS-□V	viličasti nosači	✓	✓	✓	✓	✓	✓	✓
TFSS-1CS	vijčana stezaljka	✓	✓	✓	✓	✓	✓	–
35/7,5□SIN	nosači prema standardizaciji EN50022	✓	✓	✓	✓	✓	✓	✓

Zaštitne strujne sklopke u mrežama sa zaštitnim vodičem najsuvremenije su naprave za zaštitu od indirektnog dodira, ali ponekad mogu pružiti i zaštitu od izravnog dodira. Zaštitna sklopka automatski proradi, ako struja greške koja nastaje u štice noj mreži (npr. zbog kvara na izolaciji ili izravnog spoja) dostigne kritičnu vrijednost. Za neovisne struje kratkog spoja većih od 6000 A preporučuje se uporaba osigurača. Primjena zaštitne sklopke se preporučuje, a u nekim slučajevima je i obvezatna, kao primjerice: uz vanjske priključke, na gradilištima, uz miješalicu za beton, «jacuzzi» kade itd.



EVO MODULARNI PROIZVODI

Automatski osigurači,
6 kA-10 kA

F/16

Automatski
osigurači, 1+N

F/19

Kombinirane
zaštitne sklopke

F/19

Zaštitne strujne
sklopke

F/21

Rastavljačke
sklopke

F/23

Izmjenične sklopke



F/24

Rastavne sklopke s
lokotom

F/25

Signalne svjetiljke



F/25

Modularna tipkala



F/26

Sigurnosni transforma-
tori (za zvonca)

F/26

Instalacijski
sklopnici

F/27

Releji za automatsko
ponovno uključivanje

F/28

Naše novitete potražite u web trgovini!

Pomoćni kontakt i kontakt za dojavu kvara

230/400 V AC	x5.000	x4.000	IP 20	35x7.5	[mm ²] 0,5-4	Ta -25..+55°C	U _i 500 V	V0 UL94
-----------------	--------	--------	--------------	--------	-----------------------------	----------------	-------------------------	-------------------

Piktogrami **F/0**

TRACON		I _n (A) 400 V AC	I _n (A) 230 V AC	I _n (A) 110 V DC	I _n (A) 48 V DC	I _n (A) 24 V DC
EVOZ-AUX11	EVOZ					
EVOH-AUX11	EVOH					
EVOTDA-AUX11	EVOTDA					
EVOZ-AL	EVOZ	3 A	6 A	1 A	2 A	4 A
EVOH-AL	EVOH					
EVOTDA-AL	EVOTDA					

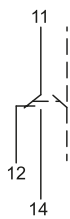
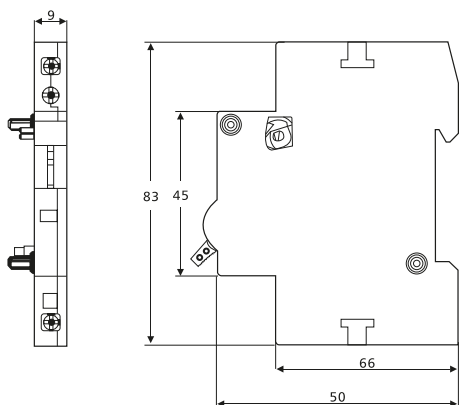

Okidač za radnu struju (shunt) i okidač za smanjeni i povećani napon

230/400 V AC	x4.000	x3.000	IP 20	35x7.5	[mm ²] 0,5-4	Ta -25..+55°C	U _i 500 V	V0 UL94
-----------------	--------	--------	--------------	--------	-----------------------------	----------------	-------------------------	-------------------



TRACON		U _m	U _{up}	U _{down}
EVOZ-SR*	EVOZ	110-415 V AC / 110-220 V DC	–	–
EVOH-SR*	EVOH	110-415 V AC / 110-220 V DC	–	–
EVOTDA-SR*	EVOTDA	110-415 V AC / 110-220 V DC	–	–
EVOZ-UOVR	EVOZ	–	280 V ± 5%	170 V ± 5%
EVOH-UOVR	EVOH	–	280 V ± 5%	170 V ± 5%
EVOTDA-UOVR	EVOTDA	–	280 V ± 5%	170 V ± 5%

*Okidač na radnu struju

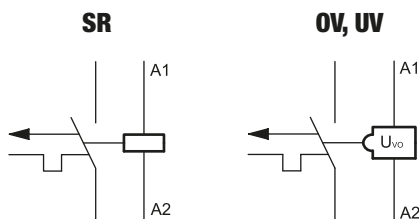
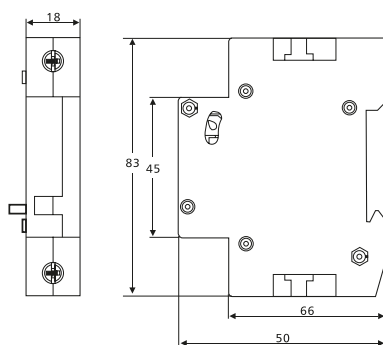

EVOZ automatski osigurači

230/400 V AC
 $\times 20.000$
 $\times 4.000$
IP 20
35x7.5
[mm²] 1,0-25
Ta -25..+55°C
500 V Ui
V0 UL94
12t 3
Icn EN 60898 6 kA
OFF

TRACON		I _n (A)
B	C	
EVOZ1B1	EVOZ1C1	1
EVOZ1B2	EVOZ1C2	2
EVOZ1B4	EVOZ1C4	4
EVOZ1B6	EVOZ1C6	6
EVOZ1B10	EVOZ1C10	10
EVOZ1B13	EVOZ1C13	13
EVOZ1B16	EVOZ1C16	16
EVOZ1B20	EVOZ1C20	20
EVOZ1B25	EVOZ1C25	25
EVOZ1B32	EVOZ1C32	32
EVOZ1B40	EVOZ1C40	40
EVOZ1B50	EVOZ1C50	50
EVOZ1B63	EVOZ1C63	63
EVOZ2B1	EVOZ2C1	1
EVOZ2B2	EVOZ2C2	2
EVOZ2B4	EVOZ2C4	4
EVOZ2B6	EVOZ2C6	6
EVOZ2B10	EVOZ2C10	10
EVOZ2B13	EVOZ2C13	13
EVOZ2B16	EVOZ2C16	16
EVOZ2B20	EVOZ2C20	20
EVOZ2B25	EVOZ2C25	25
EVOZ2B32	EVOZ2C32	32
EVOZ2B40	EVOZ2C40	40
EVOZ2B50	EVOZ2C50	50
EVOZ2B63	EVOZ2C63	63

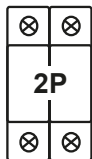

TRACON		I _n (A)
B	C	
EVOZ3B1	EVOZ3C1	1
EVOZ3B2	EVOZ3C2	2
EVOZ3B4	EVOZ3C4	4
EVOZ3B6	EVOZ3C6	6
EVOZ3B10	EVOZ3C10	10
EVOZ3B13	EVOZ3C13	13
EVOZ3B16	EVOZ3C16	16
EVOZ3B20	EVOZ3C20	20
EVOZ3B25	EVOZ3C25	25
EVOZ3B32	EVOZ3C32	32
EVOZ3B40	EVOZ3C40	40
EVOZ3B50	EVOZ3C50	50
EVOZ3B63	EVOZ3C63	63
EVOZ4B1	EVOZ4C1	1
EVOZ4B2	EVOZ4C2	2
EVOZ4B4	EVOZ4C4	4
EVOZ4B6	EVOZ4C6	6
EVOZ4B10	EVOZ4C10	10
EVOZ4B13	EVOZ4C13	13
EVOZ4B16	EVOZ4C16	16
EVOZ4B20	EVOZ4C20	20
EVOZ4B25	EVOZ4C25	25
EVOZ4B32	EVOZ4C32	32
EVOZ4B40	EVOZ4C40	40
EVOZ4B50	EVOZ4C50	50
EVOZ4B63	EVOZ4C63	63

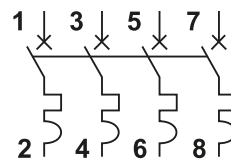
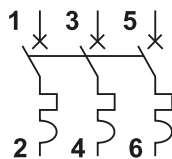
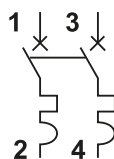
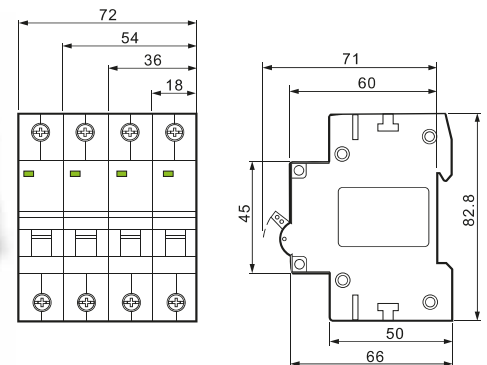
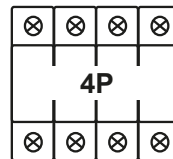
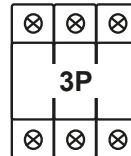

RELEVANT STANDARD
EN 60898-1

RELEVANT STANDARD
EN 60947-2

EVOTDA automatski osigurač

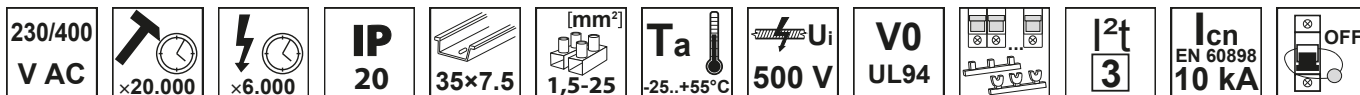

TRACON		I _n (A)
B	C	
TDA-1B-1	TDA-1C-1	1
TDA-1B-2	TDA-1C-2	2
TDA-1B-4	TDA-1C-4	4
TDA-1B-6	TDA-1C-6	6
TDA-1B-10	TDA-1C-10	10
TDA-1B-13	TDA-1C-13	13
TDA-1B-16	TDA-1C-16	16
TDA-1B-20	TDA-1C-20	20
TDA-1B-25	TDA-1C-25	25
TDA-1B-32	TDA-1C-32	32
TDA-1B-40	TDA-1C-40	40
TDA-1B-50	TDA-1C-50	50
TDA-1B-63	TDA-1C-63	63
<hr/>		
TDA-2B-1	TDA-2C-1	1
TDA-2B-2	TDA-2C-2	2
TDA-2B-4	TDA-2C-4	4
TDA-2B-6	TDA-2C-6	6
TDA-2B-10	TDA-2C-10	10
TDA-2B-13	TDA-2C-13	13
TDA-2B-16	TDA-2C-16	16
TDA-2B-20	TDA-2C-20	20
TDA-2B-25	TDA-2C-25	25
TDA-2B-32	TDA-2C-32	32
TDA-2B-40	TDA-2C-40	40
TDA-2B-50	TDA-2C-50	50
TDA-2B-63	TDA-2C-63	63

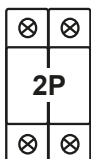
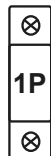

TRACON		I _n (A)
B	C	
TDA-3B-1	TDA-3C-1	1
TDA-3B-2	TDA-3C-2	2
TDA-3B-4	TDA-3C-4	4
TDA-3B-6	TDA-3C-6	6
TDA-3B-10	TDA-3C-10	10
TDA-3B-13	TDA-3C-13	13
TDA-3B-16	TDA-3C-16	16
TDA-3B-20	TDA-3C-20	20
TDA-3B-25	TDA-3C-25	25
TDA-3B-32	TDA-3C-32	32
TDA-3B-40	TDA-3C-40	40
TDA-3B-50	TDA-3C-50	50
TDA-3B-63	TDA-3C-63	63
<hr/>		
TDA-4B-1	TDA-4C-1	1
TDA-4B-2	TDA-4C-2	2
TDA-4B-4	TDA-4C-4	4
TDA-4B-6	TDA-4C-6	6
TDA-4B-10	TDA-4C-10	10
TDA-4B-13	TDA-4C-13	13
TDA-4B-16	TDA-4C-16	16
TDA-4B-20	TDA-4C-20	20
TDA-4B-25	TDA-4C-25	25
TDA-4B-32	TDA-4C-32	32
TDA-4B-40	TDA-4C-40	40
TDA-4B-50	TDA-4C-50	50
TDA-4B-63	TDA-4C-63	63

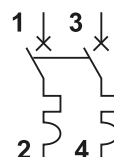
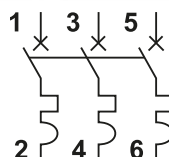
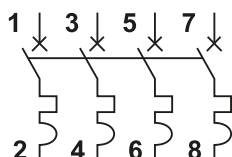
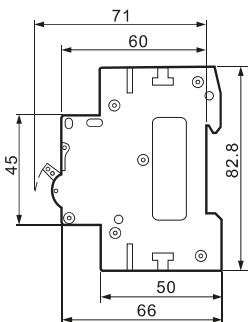
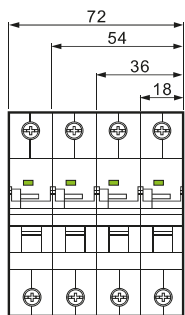
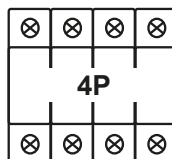
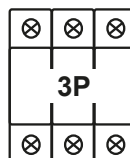

RELEVANT STANDARD
EN 60898



EVOH automatski osigurači za velike struje

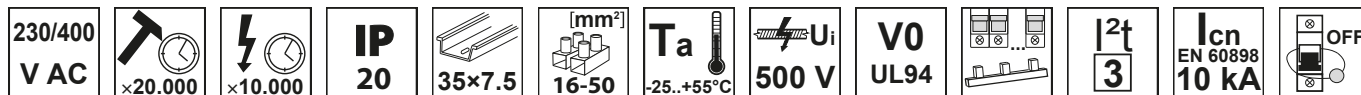

TRACON		I_n (A)
	EVOH163	63
	EVOH180	80
	EVOH1100	100
	EVOH1125	125

TRACON		I_n (A)
	EVOH363	63
	EVOH380	80
	EVOH3100	100
	EVOH3125	125

TRACON		I_n (A)
	EVOH263	63
	EVOH280	80
	EVOH2100	100
	EVOH2125	125

TRACON		I_n (A)
	EVOH463	63
	EVOH480	80
	EVOH4100	100
	EVOH4125	125

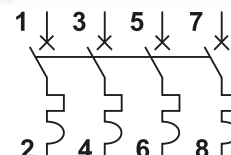
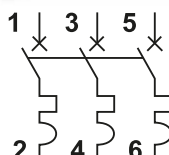
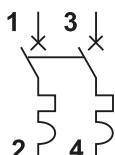

Isklopne karakteristike

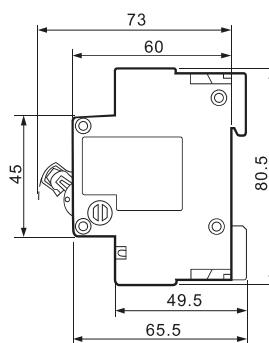
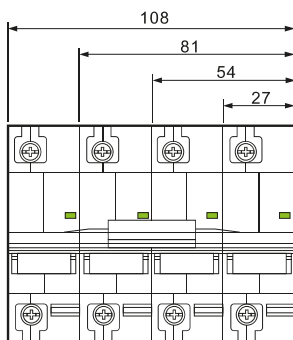
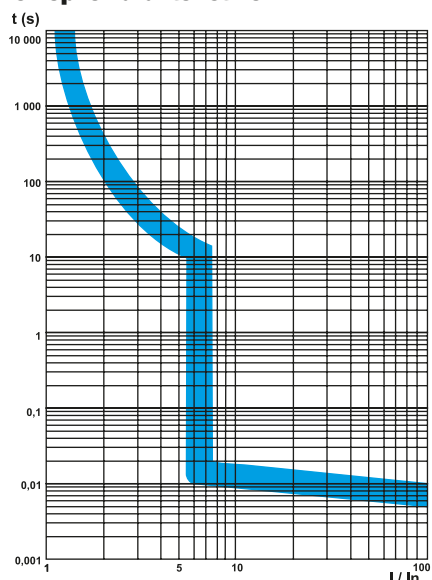

**RELEVANT STANDARD
EN 60947-2**



EVON automatski osigurači

230 V AC
 $\times 20.000$
 $\times 4.000$
IP 20
35x7.5
[mm²] 1,0-10
Ta -25..+55°C
500 V
V0 UL94
3
Icn EN 60898 4,5 kA
OFF

TRACON		I _n (A)

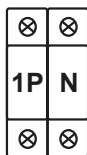

EVONC6	6
EVONC10	10
EVONC16	16
EVONC20	20
EVONC25	25
EVONC32	32

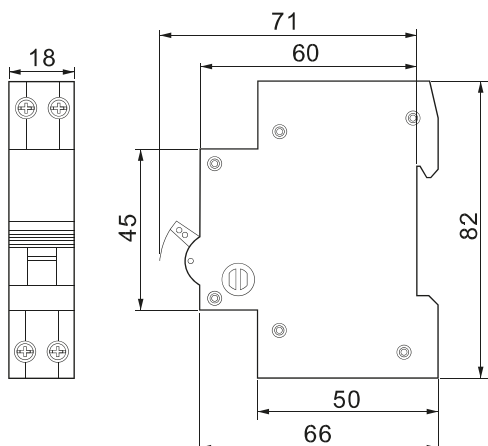
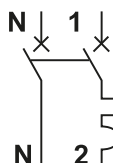

* dvopoli osigurač s jednim polom za fazu i drugim za nulu (N).

RELEVANT STANDARD
EN 60898-1

Piktogrami **F/0**

EVOKE kombinirana zaštitna sklopka širine 1 modula

230 V AC
 $\times 10.000$
 $\times 4.000$
IP 20
35x7.5
[mm²] 1-16
Ta -25..+40°C
690 V
V0 UL94
AC
Icn EN 60898 6 kA
OFF

TRACON		I _n (A)	I Δ _n (mA)



EVOKEB603	EVOKEC603	6	30
EVOKEB1003	EVOKEC1003	10	30
EVOKEB1303	EVOKEC1303	13	30
EVOKEB1603	EVOKEC1603	16	30
EVOKEB2003	EVOKEC2003	20	30
EVOKEB2503	EVOKEC2503	25	30
EVOKEB3203	EVOKEC3203	32	30
EVOKEB4003	EVOKEC4003	40	30

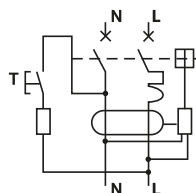

E3

Isklopne karakteristike

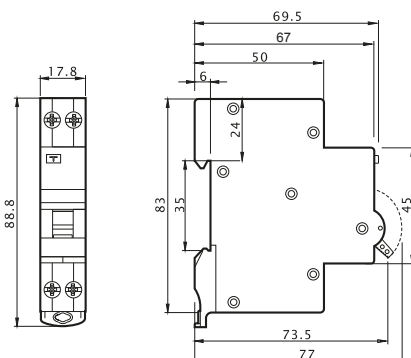
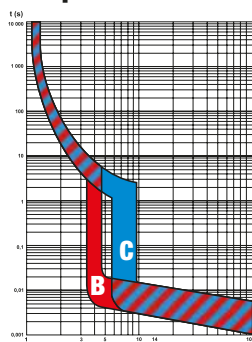

RELEVANT STANDARD
EN 61009-1

EVOK kombinirane zaštitne sklopke

230 V AC	x10.000	x4.000	IP 20	35x7.5	[mm ²] 1,5-25	Ta -25..+40°C	U _i 690 V	V0 UL94		I _{cn} EN 60898 4,5 kA	
----------	---------	--------	-------	--------	---------------------------	----------------	----------------------	---------	--	---------------------------------	--



Isklopne karakteristike

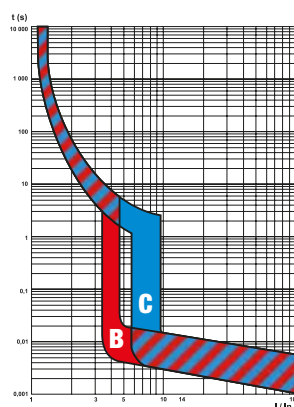

TRACON		I _n (A)	I _{Δn} (mA)
EVOK2B603	EVOK2C603	6	30
EVOK2B1003	EVOK2C1003	10	30
EVOK2B1603	EVOK2C1603	16	30
EVOK2B2003	EVOK2C2003	20	30
EVOK2B2503	EVOK2C2503	25	30
EVOK2B3203	EVOK2C3203	32	30
EVOK2B4003	EVOK2C4003	40	30

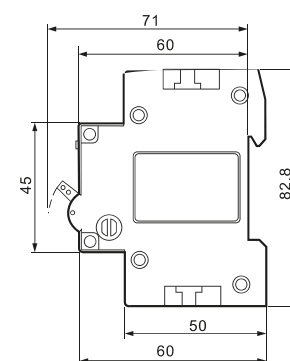
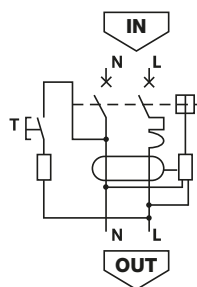
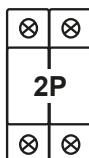

RELEVANT STANDARD
EN 61009-1



Piktogrami **F/0**

EVOKM kombinirane zaštitne sklopke, elektromehaničke

230 V AC	x10.000	x4.000	IP 20	35x7.5	[mm ²] 1,5-25	Ta -25..+55°C	U _i 690 V	V0 UL94		I _{cn} EN 60898 6 kA	
----------	---------	--------	-------	--------	---------------------------	----------------	----------------------	---------	--	-------------------------------	--



Isklopne karakteristike

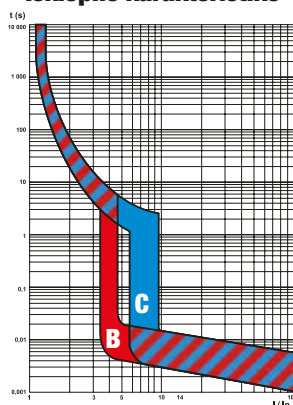

TRACON		I _n (A)	I _{Δn} (mA)
EVOKM2B603	EVOKM2C603	6	30
EVOKM2B1003	EVOKM2C1003	10	30
EVOKM2B1603	EVOKM2C1603	16	30
EVOKM2B2003	EVOKM2C2003	20	30
EVOKM2B2503	EVOKM2C2503	25	30
EVOKM2B3203	EVOKM2C3203	32	30
EVOKM2B4003	EVOKM2C4003	40	30
EVOKM2B5003	EVOKM2C5003	50	30
EVOKM2B6303	EVOKM2C6303	63	30

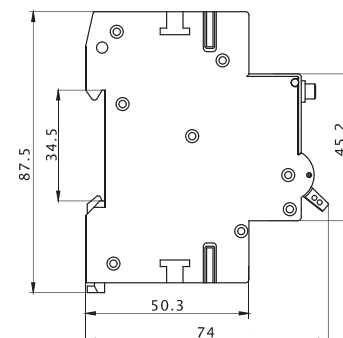
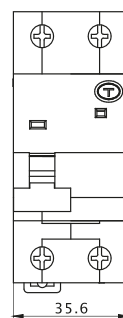
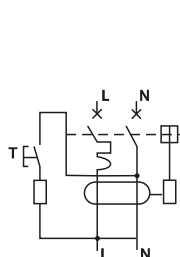
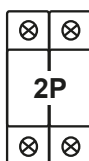

RELEVANT STANDARD
EN 61009-1



Elektromehanička kombinirana zaštitna sklopka zaštitu protiv strujnog udara pruža i u slučaju prekida neutralnog vodiča!

EVOV zaštitne strujne sklopke

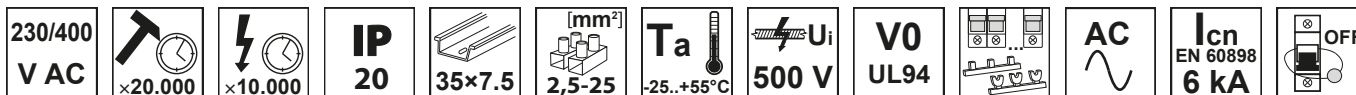

TRACON	I_n (A)	$I_{\Delta n}$ (mA)
EVOV2P2503	25	30
EVOV2P4003	40	30
EVOV2P6303	63	30
EVOV2P8003	80	30
EVOV2P251	25	100
EVOV2P401	40	100
EVOV2P631	63	100
EVOV2P801	80	100
EVOV2P253	25	300
EVOV2P403	40	300
EVOV2P633	63	300
EVOV2P803	80	300
EVOV4P2503	25	30
EVOV4P4003	40	30
EVOV4P6303	63	30
EVOV4P8003	80	30
EVOV4P251	25	100
EVOV4P401	40	100
EVOV4P631	63	100
EVOV4P801	80	100
EVOV4P253	25	300
EVOV4P403	40	300
EVOV4P633	63	300
EVOV4P803	80	300

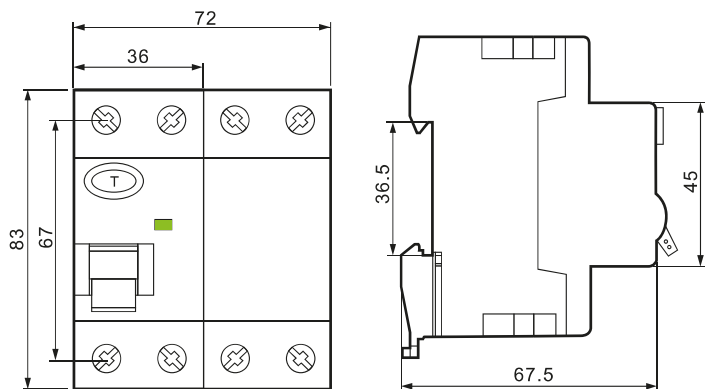
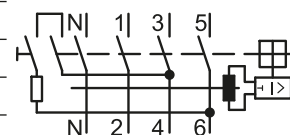
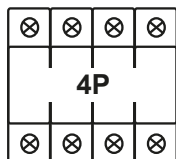
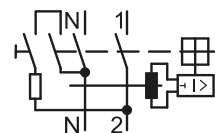
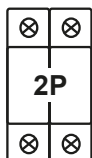

Za izmjenične mreže!

**RELEVANT STANDARD
EN 61008-1**



EVOG zaštitne strujne sklopke



TRACON	I_n (A)	$I_{\Delta n}$ (mA)
EVOG2P2503	25	30
EVOG2P4003	40	30
EVOG2P6303	63	30
EVOG2P8003	80	30
EVOG2P251	25	100
EVOG2P401	40	100
EVOG2P631	63	100
EVOG2P801	80	100
EVOG2P253	25	300
EVOG2P403	40	300
EVOG2P633	63	300
EVOG2P803	80	300
EVOG4P2503	25	30
EVOG4P4003	40	30
EVOG4P6303	63	30
EVOG4P8003	80	30
EVOG4P251	25	100
EVOG4P401	40	100
EVOG4P631	63	100
EVOG4P801	80	100
EVOG4P253	25	300
EVOG4P403	40	300
EVOG4P633	63	300
EVOG4P803	80	300

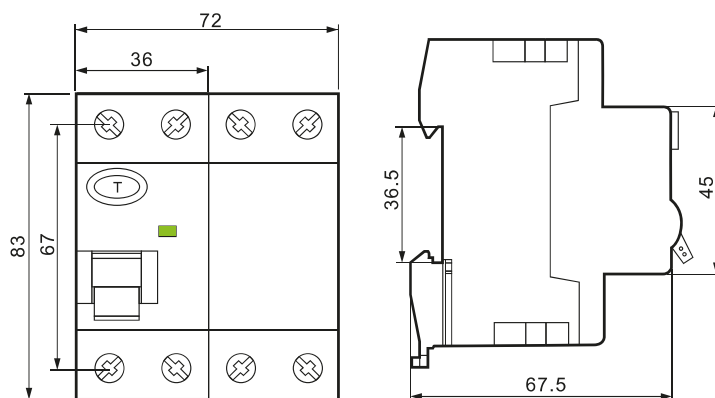
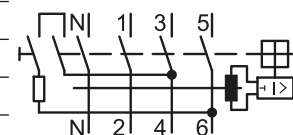
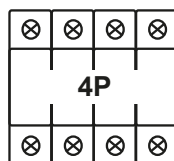
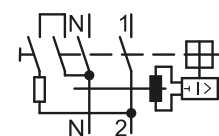
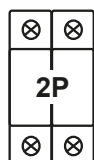

Za mreže s izmjeničnom i pulsirajućom istosmjernom strujom!





RELEVANT STANDARD
EN 61008-1

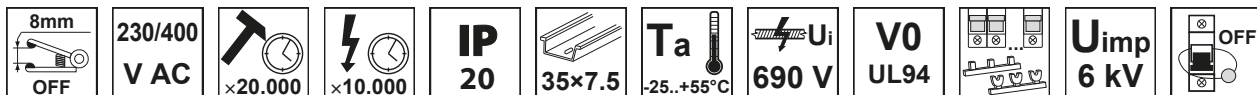

J/10-J/21

EVOTIK rastavljачke sklopke

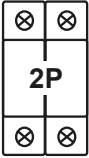

	TRACON	In (A)	mm ²
	TIK1-20	20	1,5-50
	TIK1-25	25	
	TIK1-32	32	
	TIK1-40	40	
	TIK1-63	63	
	TIK1-80	80	
	TIK1-100	100	
	TIK1-125	125	1,5-50
	TIK2-20	20	
	TIK2-25	25	
	TIK2-32	32	
	TIK2-40	40	
	TIK2-63	63	
	TIK2-80	80	
	TIK2-100	100	
	TIK2-125	125	

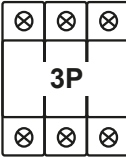
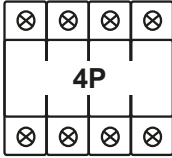
	TRACON	In (A)	mm ²
	TIK3-20	20	1,5-50
	TIK3-25	25	
	TIK3-32	32	
	TIK3-40	40	
	TIK3-63	63	
	TIK3-80	80	
	TIK3-100	100	
	TIK3-125	125	1,5-50
	TIK4-20	20	
	TIK4-25	25	
	TIK4-32	32	
	TIK4-40	40	
	TIK4-63	63	
	TIK4-80	80	
	TIK4-100	100	
	TIK4-125	125	

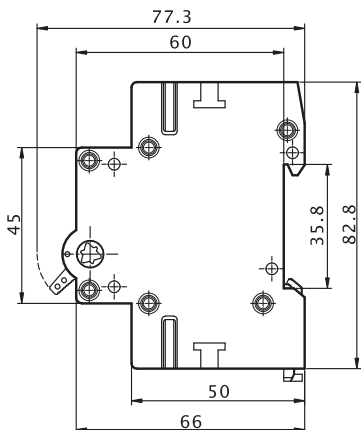
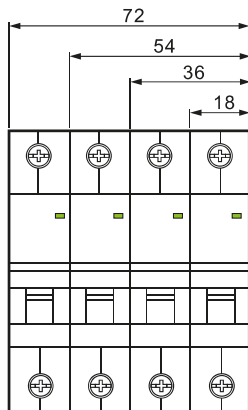
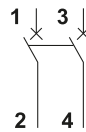
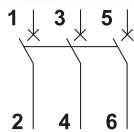
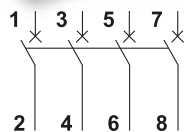
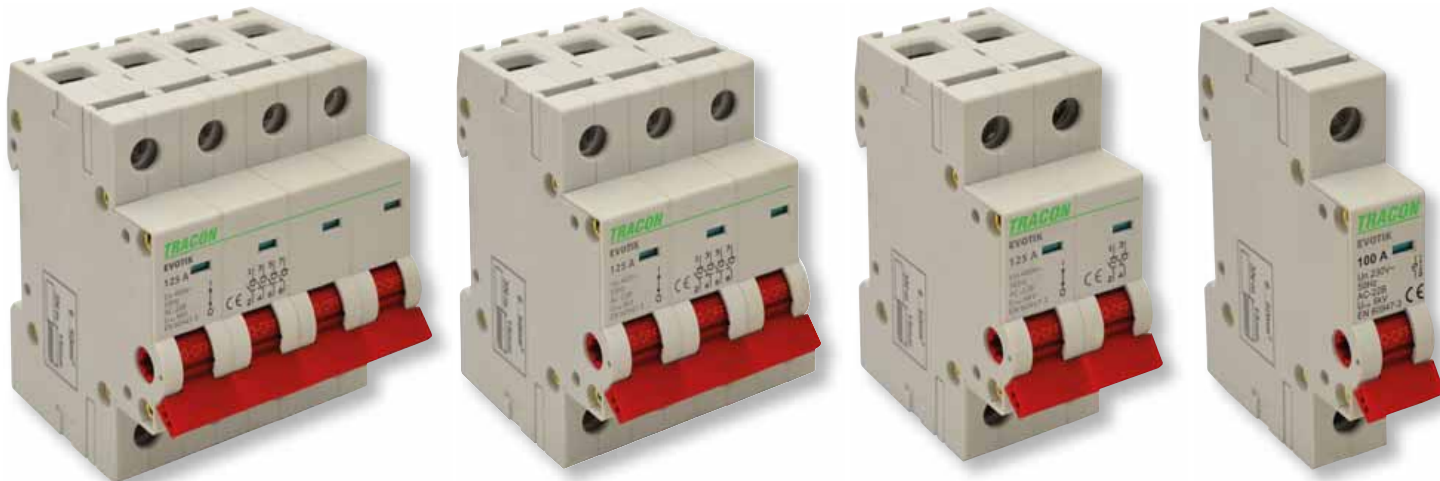

RELEVANT STANDARD
EN 60947-3



F/25

EVOSVK izmjenične sklopke za redanje

230/400 V AC	x30.000	x10.000	IP 20	35x7.5	[mm ²] 1-16	Ta -25..+55°C	U_i 690 V	V0 UL94		U_{imp} 6 kV	1 0 2
-----------------	---------	---------	--------------	--------	-------------------------	----------------------	----------------------------	----------------	--	-----------------------------	-------

TRACON	I _n (A)
--------	--------------------



SVK1-16	16
SVK1-32	32
SVK1-63	63

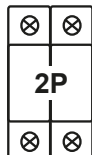

SVK2-16	16
SVK2-32	32
SVK2-63	63

TRACON	I _n (A)
--------	--------------------

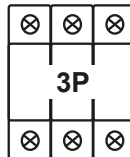

SVK3-16	16
SVK3-32	32
SVK3-63	63

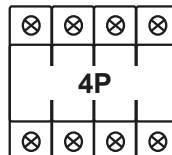

SVK4-16	16
SVK4-32	32
SVK4-63	63

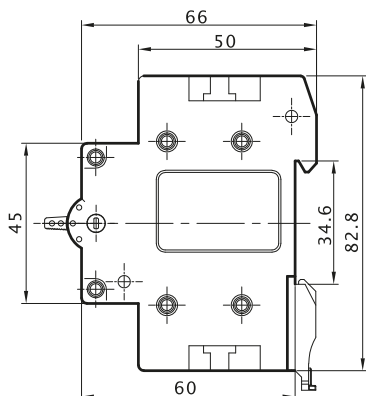
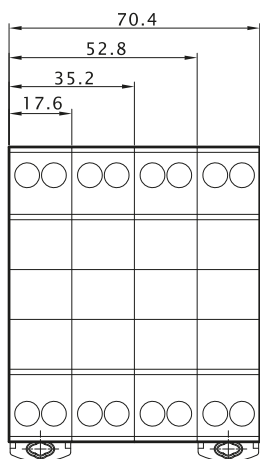
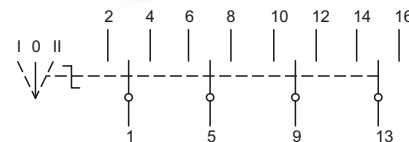
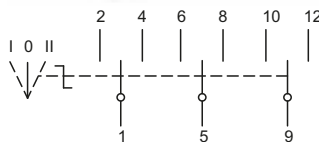
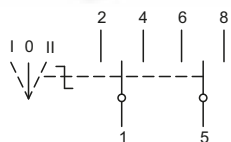
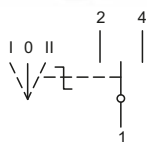

**RELEVANT STANDARD
EN 60947-3**

**RELEVANT STANDARD
EN 60669-1**

**TÜV MEEI TEST DOCUMENTATION
28211822 001**

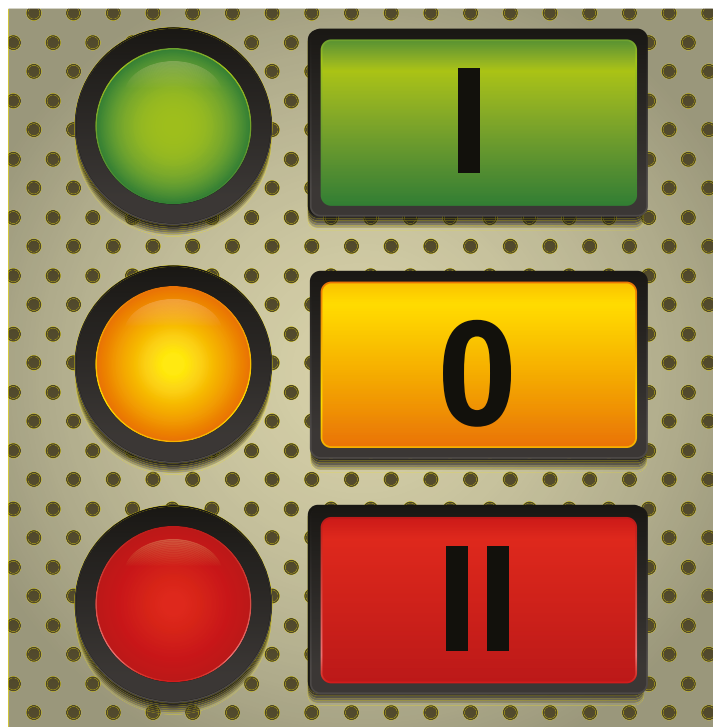

EVOMS rastavne sklopke za redanje, s lokotom

230/400 V AC
IP 20
35×7.5
Ta -25..+55°C
Ui 800 V
OFF

Piktogrami
F/0

TRACON	Ith (40 °C)	A (mm)	B (mm)	C (mm)	D (mm)	E (mm)	mm ²
EVOMS16/3	16A/3P						
EVOMS20/3	20A/3P	73,3	81	65,5	75,5	36,5	1,5-16
EVOMS25/3	25A/3P						
EVOMS40/3	40A/3P						
EVOMS80/3	80A/3P						
EVOMS100/3	100A/3P	88	97,5	76,5	93,5	52	25-50
EVOMS125/3	125A/3P						

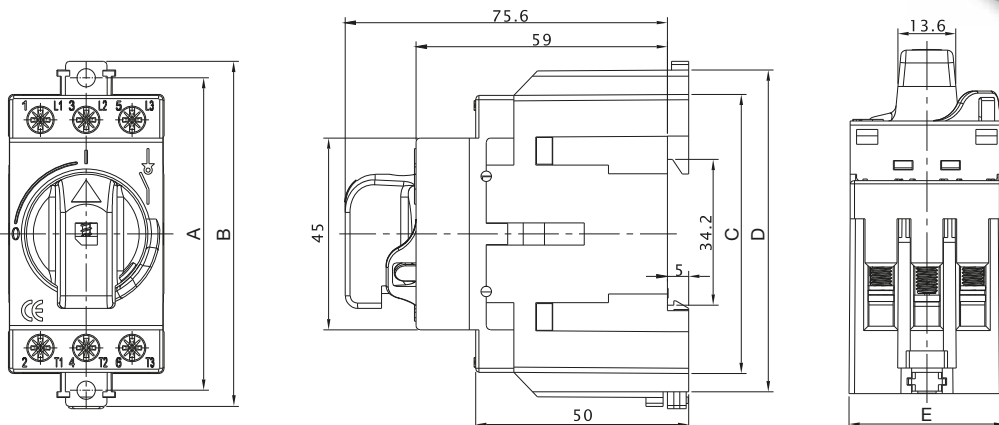

RELEVANT STANDARD
EN 60947-3

EVOSLJL signalne svjetiljke

Pm 0,8 VA
20.000 [h]
IP 20
1-25 [mm²]
35×7.5
Ta -25..+55°C

Piktogrami
F/0

TRACON	Un	LED
SLJL-AC230-P	230 V AC	× 1 LED
SLJL-AC230-Z	230 V AC	× 1 LED
SLJL-AC230-S	230 V AC	× 1 LED
SLJL-AC230-F	230 V AC	× 1 LED
SLJL-AC230-K	230 V AC	× 1 LED
SLJL-AC24-P	24 V AC	× 1 LED
SLJL-AC24-Z	24 V AC	× 1 LED
SLJL-AC24-S	24 V AC	× 1 LED
SLJL-AC24-F	24 V AC	× 1 LED
SLJL-AC24-K	24 V AC	× 1 LED
SLJL-AC230-3Z	3×230 V AC	× 3 LED
SLJL-AC230-SZP	3×230 V AC	× 3 LED
SLJL-DC220-P	220 V DC	× 1 LED
SLJL-DC220-Z	220 V DC	× 1 LED
SLJL-DC220-S	220 V DC	× 1 LED
SLJL-DC220-F	220 V DC	× 1 LED
SLJL-DC220-K	220 V DC	× 1 LED
SLJL-DC24-P	24 V DC	× 1 LED
SLJL-DC24-Z	24 V DC	× 1 LED
SLJL-DC24-S	24 V DC	× 1 LED
SLJL-DC24-F	24 V DC	× 1 LED
SLJL-DC24-K	24 V DC	× 1 LED

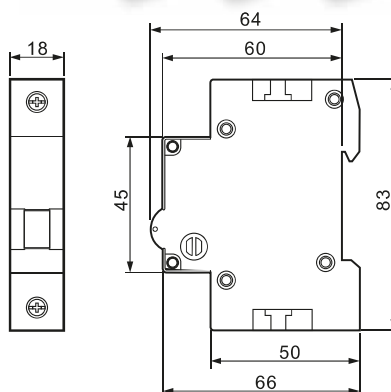

RELEVANT STANDARD
EN 62094-1
EN 60947-5

EVOP modularno tipkalo i sklopka

230 V AC
 $\times 250.000$
 $\times 10.000$
IP 20
35x7.5
[mm²] 1-10
Ta -5..+55 °C
500 V U_i
V0 UL94

Piktogrami F/O



EVOPB

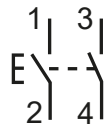

EVOPBL

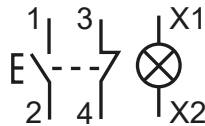

EVOPS

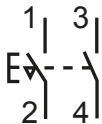

EVOPB2

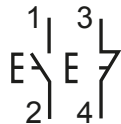

EVOPSL

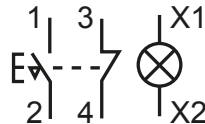

TRACON	I _{th}	I _e (AC-14) (230V AC)	NC NO
EVOPS	16 A	6 A	2 NO
EVOPB	16 A	6 A	2 NO
EVOPB2	16 A	6 A	1 NO, 1 NC
EVOPBL	16 A	6 A	1 NO+1 NC
EVOPSL	16 A	6 A	1 NO+1 NC

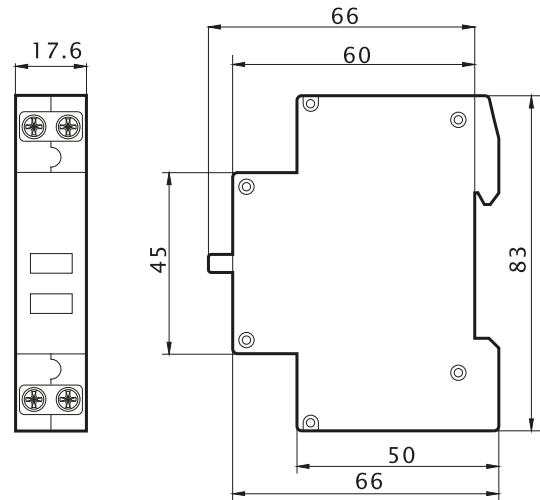

RELEVANT STANDARD
EN 60947-5-1

EVOBT sigurnosni transformator (za zvonca)

IP 20
35x7.5
[mm²] 1,5-10
Ta -25..+55 °C
500 V U_i
V0 UL94

Piktogrami F/O



EVOBT15/1



EVOBT30/1

TRACON	P _s	U _{pr}	U _{sec}	I _{sec}
EVOBT15/1	max. 15 VA		4-8-12 V AC	1,25 A
EVOBT24/1	max. 15 VA	230 V AC	12-24 V AC	0,62 A
EVOBT30/1	max. 30 VA		12-12-24 V AC	1,25 A

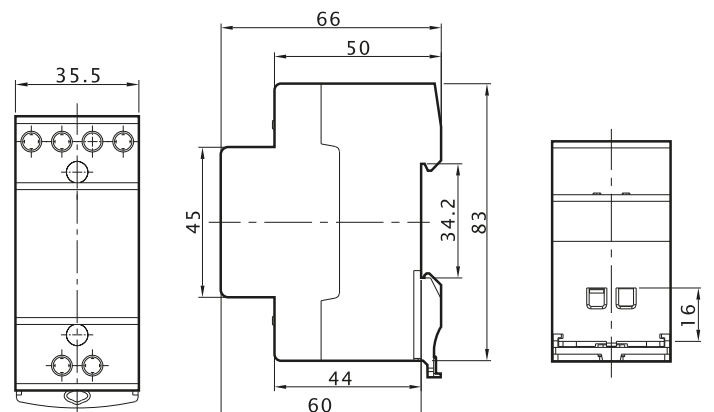

RELEVANT STANDARD
EN 60947-5-1

RELEVANT STANDARD
EN 61558-2-8

EVOHK instalacijski sklopnici

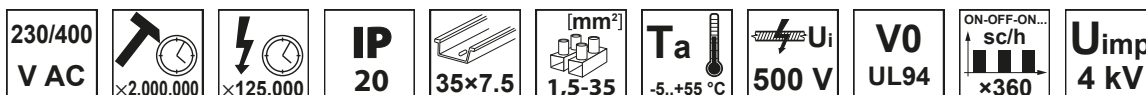

TRACON	U _m	I _n (A)	W (mm)	P _e (kW)				P _s			NC NO
				AC1 / AC7a 230V	AC3 / AC7b 230V	AC1 / AC7a 400V	AC3 / AC7b 400V				
EVOHK2-25	230 V AC	25	17,5	5	1,5	–	–	1,35 W	20A gG		2 × NO
EVOHK2-25-24	24 V AC	25	17,5	5	1,5	–	–	1,35 W	20A gG		2 × NO
EVOHK2-25V	230 V AC	25	17,5	5	1,5	–	–	1,35 W	20A gG		1 × NO+1 × NC
EVOHK2-40	230 V AC	40	35,4	9	2,2	–	–	1,55 W	32A gG		2 × NO
EVOHK2-63	230 V AC	63	35,4	11,6	3,3	–	–	1,55 W	50A gG		2 × NO
EVOHK2-80	230 V AC	80	54	16	5,5	–	–	1,55 W	63A gG		2 × NO
EVOHK2-100	230 V AC	100	54	19	6	–	–	1,55 W	80A gG		2 × NO
EVOHK4-25	230 V AC	25	35	5	1,5	16	4	1,35 W	20A gG		4 × NO
EVOHK4-25-24	24 V AC	25	35	5	1,5	16	4	1,35 W	20A gG		4 × NO
EVOHK4-40	230 V AC	40	53,3	9	2,2	27,5	12,5	1,55 W	32A gG		4 × NO
EVOHK4-63	230 V AC	63	53,3	11,6	3,3	40	15	1,55 W	50A gG		4 × NO
EVOHK4-80	230 V AC	80	108	16	5,5	50	18,5	1,55 W	63A gG		4 × NO
EVOHK4-100	230 V AC	100	108	19	6	60	22	1,55 W	80A gG		4 × NO

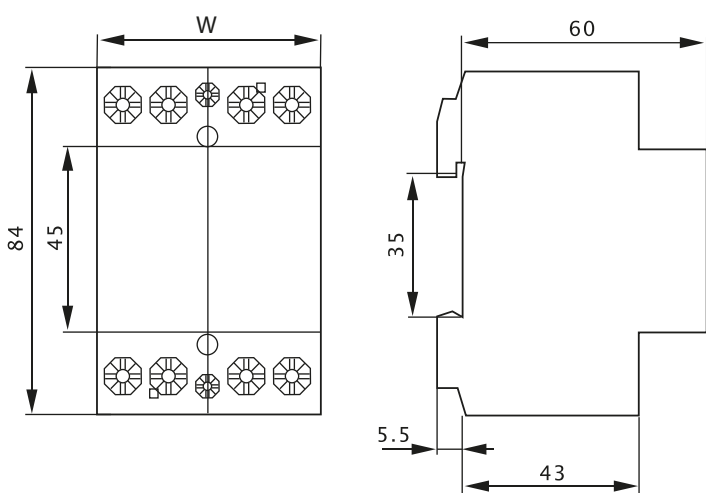

RELEVANT STANDARD
EN 60947-4-1

RELEVANT STANDARD
EN 61095

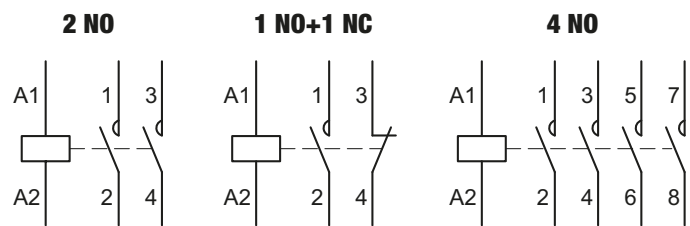

UČITAJTE ŠIFRU!

- Pogledajte naše novosti
- Budite u tijeku

Naša ponuda se brzo i kontinuirano razvija!
Katalog prikazuje stanje u travnju 2021. godine.
Za aktualne informacije posjetite našu web stranicu!

Releji za povećani i smanjeni napon s automatskim ponovnim uključivanjem

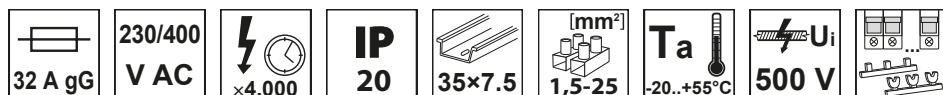

TRACON	2P	4P
	EVOU02	EVOU04
	EVOUC2P63	EVOU04P63
Nazivni napon	230 V AC	230 V AC (L-N)
Nazivna frekvencija	50 Hz	
Nazivna struja	40 A (AC 1)	
Snaga utroška	AC max. 3 VA	
Gornja razina naponske zaštite	265 V (fix)	265 V (L-N) (fix)
Gornja razina ponovnog uključivanja	257 V (fix)	257 V (L-N) (fix)
Donja razina naponske zaštite	175 V (fix)	175 V (L-N) (fix)
Donja razina ponovnog uključivanja	180 V (fix)	180 V (L-N) (fix)
Vrijeme isklapanja	1 s	
Kašnjenje uklapanja	2 s	
Vrijeme ponovnog uključivanja	30 s	
Pogreška mjerenja	≤1%	
Masa	120 g	250 g



EVOU02

EVOU04

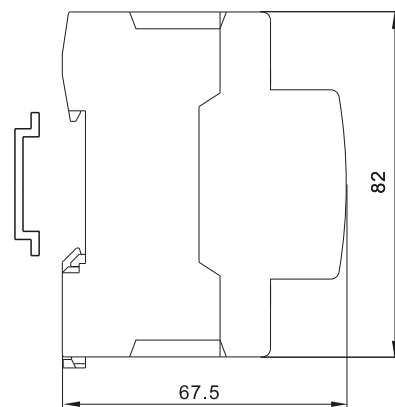
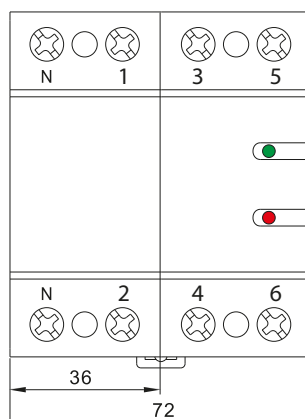

- Za zaštitu kućanskih aparata od povećanog i smanjenog napona.
- Automatski se uključuje, čim se napon ponovno uspostavi!
- Indikacija stanja pomoću LED

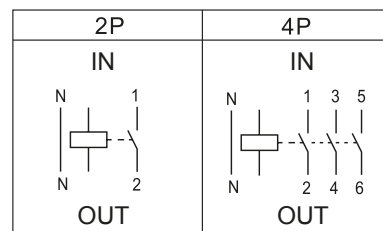
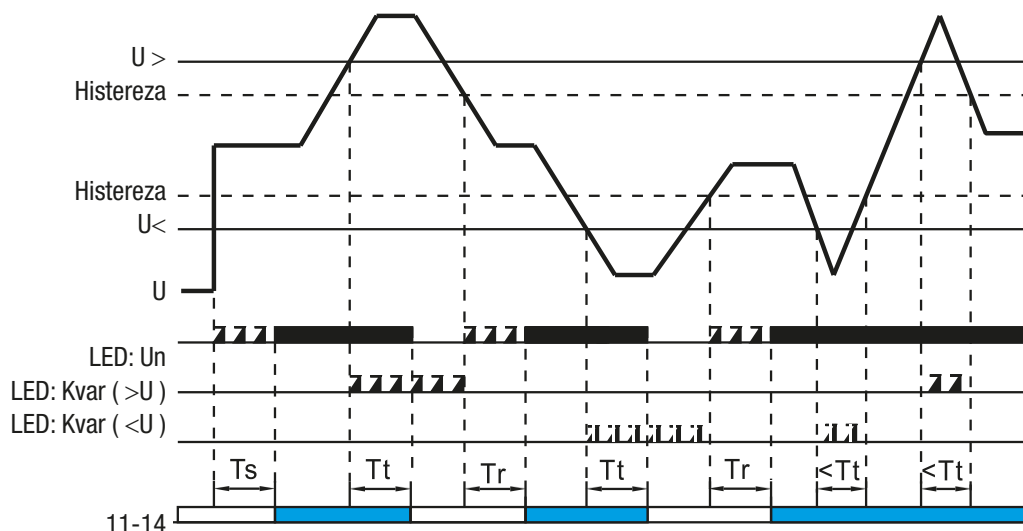

Ts: Vrijeme uspostave rada
Tt: Kašnjenje isklapanja
Tr: Vrijeme resetiranja

Pomoćni kontakt

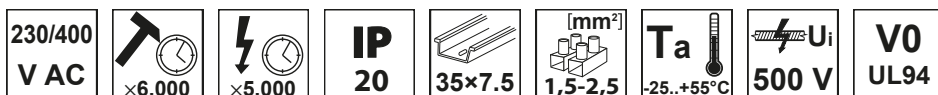

TRACON			I_n (A) (415 V AC)	I_n (A) (240 V AC)	I_n (A) (125 V DC)	I_n (A) (48 V DC)	I_n (A) (24 V DC)
TDZ-F2		TDZ	3 A	6 A	1 A	2 A	4 A

Označava uklopljeno ili isključeno stanje kontakta automatskog osigurača.

Okidač za radnu struju (shunt)

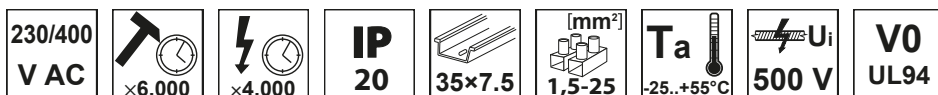

TRACON			U_m
C60-S2		TDZ	110-415 V AC / 110-220 V DC

Pod utjecajem naglo priključenog pogonskog napona isključuje automatski osigurač, prema tome prikladan je za daljinsko isklapanje. U slučaju isklapanja reset-dugme iskoči i tek po vraćanju istog automatski osigurač se može ponovno uklopiti. Pozor: Pogonski namot smije biti pod naponom max. 10 sekundi!

Okidač za smanjeni i povećani napon

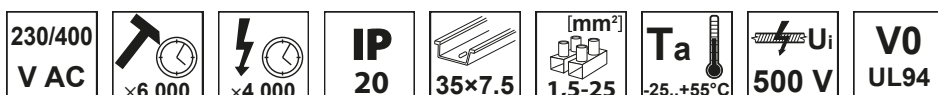

TRACON			U_{up}	U_{down}
C60-U2/02		TDZ	280 V ± 5 %	170 V ± 5 %

Isključuje automatski osigurač ukoliko mrežni napon odstupa od zadanog pogonskog područja i time štiti potrošačeve aparate od štetnog utjecaja promjenjivog napona. Automatski osigurač se može uključiti tek kada vrijednost napona na stezaljkama okidača pada u pogonsko područje (170 V – 280 V). U slučaju isklapanja reset-dugme iskoči i tek po vraćanju istog automatski osigurač se može ponovno uklopiti.

Zasun za zaključavanje rednih zaštitnih aparata

Pomoću zasuna za zaključavanje lokotom redni zaštitni aparati ovisno o tipu mogu se osigurati u isključenom (OFF) položaju. Zasuni se mogu primijeniti na 8 – 10 mm širine izreza ručice, potreban je provrt 1 - 1,5 mm za pričvršćivanje zasunovih ušica na najvišoj točki kružnog luka s obje strane izreza. Maksimalni promjer stremena lokota: 8 mm. Zabranjena je uporaba zasuna u uklopljenom (ON) položaju!

TRACON



MDL

MB, RB, TDZ, KVKM, KVK, KVKVE, TFG, TFIG, TFV, EVO..



Automatski osigurači tipa DPN (1+ N polni)

230/400 V AC	x20.000	x6.000	IP 20	35x7.5	[mm ²] 1,5-10	Ta -25..+55°C	U_i 500 V	V0 UL94		I_{2t} 3	I_{cn} EN 60898 4,5 kA	OFF
-----------------	---------	--------	-----------------	--------	------------------------------	-------------------------	-------------------------------	-------------------	--	----------------------------	---	-----

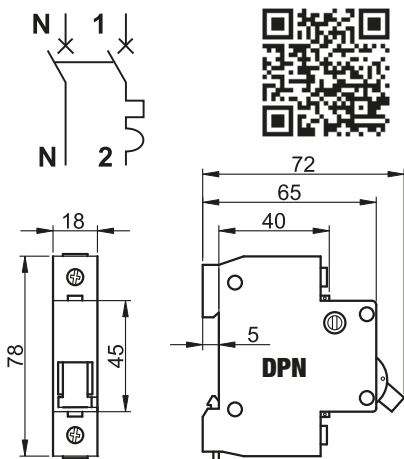

TRACON		I _n (A)
	C	
	DPN-C-6	6
	DPN-C-10	10
	DPN-C-13	13
	DPN-C-16	16
	DPN-C-20	20
	DPN-C-25	25
	DPN-C-32	32

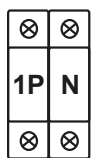

* dvopolni osigurač s jednim polom za fazu i drugim za nulu (N).

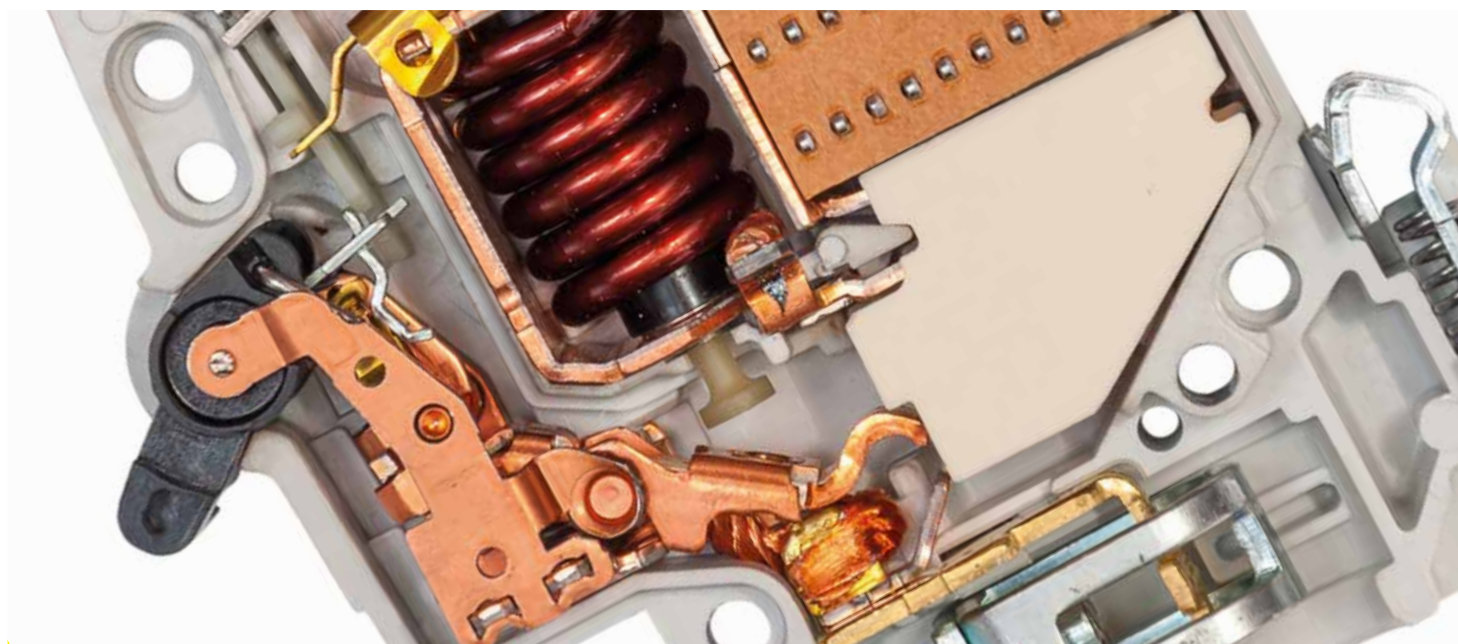

Automatski osigurači tipa MB

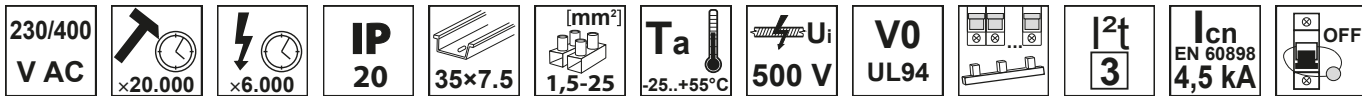

TRACON			I _n (A)
B	C		
MB-1B-6	MB-1C-6		6
MB-1B-10	MB-1C-10		10
MB-1B-13	MB-1C-13		13
MB-1B-16	MB-1C-16		16
MB-1B-20	MB-1C-20		20
MB-1B-25	MB-1C-25		25
MB-1B-32	MB-1C-32		32
MB-1B-40	MB-1C-40		40
MB-1B-50	MB-1C-50		50
MB-1B-63	MB-1C-63		63
MB-2B-6	MB-2C-6		6
MB-2B-10	MB-2C-10		10
MB-2B-13	MB-2C-13		13
MB-2B-16	MB-2C-16		16
MB-2B-20	MB-2C-20		20
MB-2B-25	MB-2C-25		25
MB-2B-32	MB-2C-32		32
MB-2B-40	MB-2C-40		40
MB-2B-50	MB-2C-50		50
MB-2B-63	MB-2C-63		63

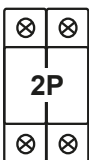

TRACON			I _n (A)
B	C		
MB-3B-6	MB-3C-6		6
MB-3B-10	MB-3C-10		10
MB-3B-13	MB-3C-13		13
MB-3B-16	MB-3C-16		16
MB-3B-20	MB-3C-20		20
MB-3B-25	MB-3C-25		25
MB-3B-32	MB-3C-32		32
MB-3B-40	MB-3C-40		40
MB-3B-50	MB-3C-50		50
MB-3B-63	MB-3C-63		63
-	MB-4C-10		10
-	MB-4C-16		16
-	MB-4C-20		20
-	MB-4C-25		25
-	MB-4C-32		32
-	MB-4C-40		40
-	MB-4C-50		50
-	MB-4C-63		63

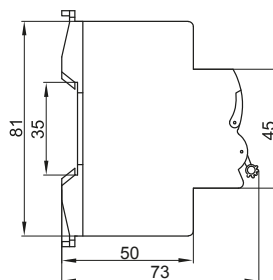
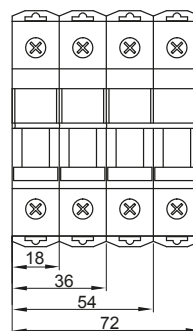
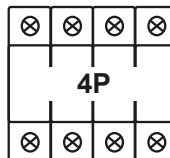

RELEVANT STANDARD
EN 60898

TÜV MEEI TEST DOCUMENTATION
03401-2014183F

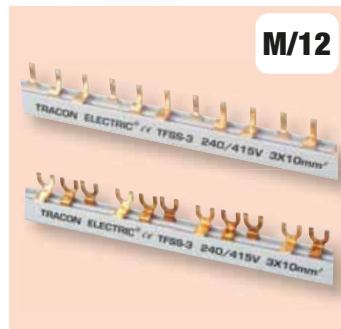
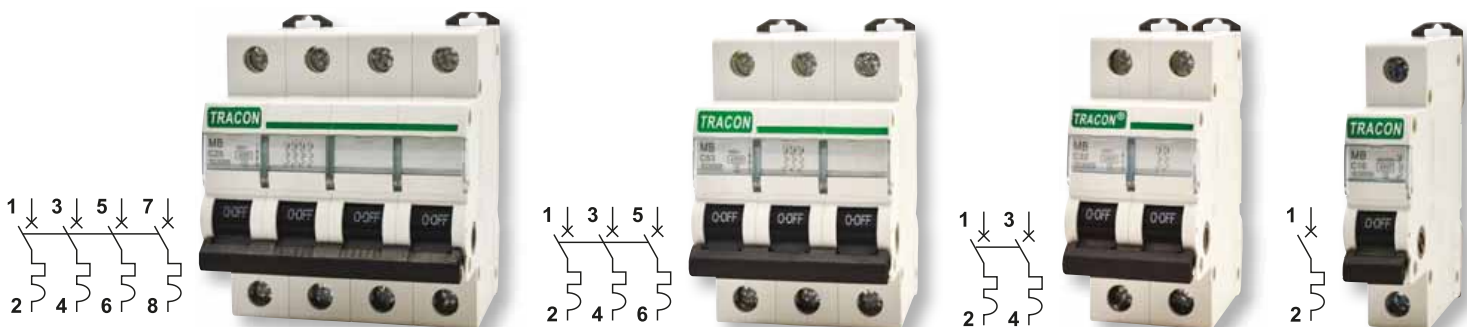

Automatski osigurači tipa TDZ

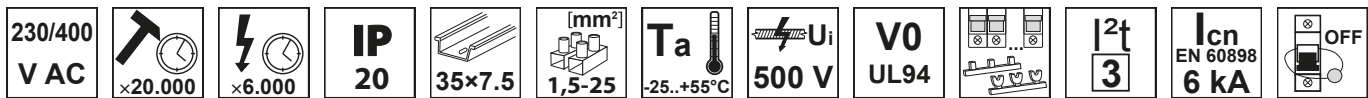

TRACON				I _n (A)
B	C	D		
TDZ-1B-1	TDZ-1C-1	TDZ-1D-1		1
TDZ-1B-2	TDZ-1C-2	TDZ-1D-2		2
TDZ-1B-4	TDZ-1C-4	TDZ-1D-4		4
TDZ-1B-6	TDZ-1C-6	TDZ-1D-6		6
TDZ-1B-10	TDZ-1C-10	TDZ-1D-10		10
TDZ-1B-13	TDZ-1C-13	TDZ-1D-13		13
TDZ-1B-16	TDZ-1C-16	TDZ-1D-16		16
TDZ-1B-20	TDZ-1C-20	TDZ-1D-20		20
TDZ-1B-25	TDZ-1C-25	TDZ-1D-25		25
TDZ-1B-32	TDZ-1C-32	TDZ-1D-32		32
TDZ-1B-40	TDZ-1C-40	TDZ-1D-40		40
TDZ-1B-50	TDZ-1C-50	TDZ-1D-50		50
TDZ-1B-63	TDZ-1C-63	TDZ-1D-63		63
TDZ-2B-1	TDZ-2C-1	TDZ-2D-1		1
TDZ-2B-2	TDZ-2C-2	TDZ-2D-2		2
TDZ-2B-4	TDZ-2C-4	TDZ-2D-4		4
TDZ-2B-6	TDZ-2C-6	TDZ-2D-6		6
TDZ-2B-10	TDZ-2C-10	TDZ-2D-10		10
TDZ-2B-13	TDZ-2C-13	TDZ-2D-13		13
TDZ-2B-16	TDZ-2C-16	TDZ-2D-16		16
TDZ-2B-20	TDZ-2C-20	TDZ-2D-20		20
TDZ-2B-25	TDZ-2C-25	TDZ-2D-25		25
TDZ-2B-32	TDZ-2C-32	TDZ-2D-32		32
TDZ-2B-40	TDZ-2C-40	TDZ-2D-40		40
TDZ-2B-50	TDZ-2C-50	TDZ-2D-50		50
TDZ-2B-63	TDZ-2C-63	TDZ-2D-63		63

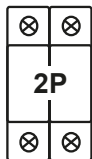
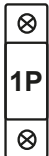

TRACON				I _n (A)
B	C	D		
TDZ-3B-1	TDZ-3C-1	TDZ-3D-1		1
TDZ-3B-2	TDZ-3C-2	TDZ-3D-2		2
TDZ-3B-4	TDZ-3C-4	TDZ-3D-4		4
TDZ-3B-6	TDZ-3C-6	TDZ-3D-6		6
TDZ-3B-10	TDZ-3C-10	TDZ-3D-10		10
TDZ-3B-13	TDZ-3C-13	TDZ-3D-13		13
TDZ-3B-16	TDZ-3C-16	TDZ-3D-16		16
TDZ-3B-20	TDZ-3C-20	TDZ-3D-20		20
TDZ-3B-25	TDZ-3C-25	TDZ-3D-25		25
TDZ-3B-32	TDZ-3C-32	TDZ-3D-32		32
TDZ-3B-40	TDZ-3C-40	TDZ-3D-40		40
TDZ-3B-50	TDZ-3C-50	TDZ-3D-50		50
TDZ-3B-63	TDZ-3C-63	TDZ-3D-63		63
TDZ-4B-1	TDZ-4C-1	TDZ-4D-1		1
TDZ-4B-2	TDZ-4C-2	TDZ-4D-2		2
TDZ-4B-4	TDZ-4C-4	TDZ-4D-4		4
TDZ-4B-6	TDZ-4C-6	TDZ-4D-6		6
TDZ-4B-10	TDZ-4C-10	TDZ-4D-10		10
TDZ-4B-13	TDZ-4C-13	TDZ-4D-13		13
TDZ-4B-16	TDZ-4C-16	TDZ-4D-16		16
TDZ-4B-20	TDZ-4C-20	TDZ-4D-20		20
TDZ-4B-25	TDZ-4C-25	TDZ-4D-25		25
TDZ-4B-32	TDZ-4C-32	TDZ-4D-32		32
TDZ-4B-40	TDZ-4C-40	TDZ-4D-40		40
TDZ-4B-50	TDZ-4C-50	TDZ-4D-50		50
TDZ-4B-63	TDZ-4C-63	TDZ-4D-63		63

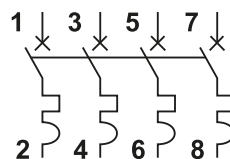
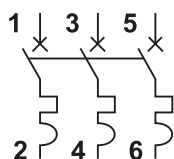
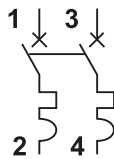
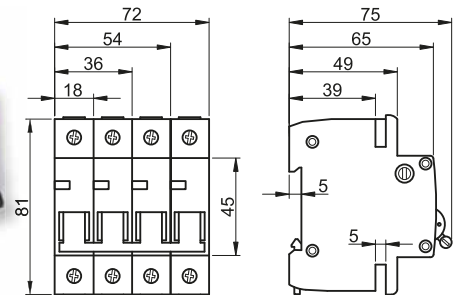
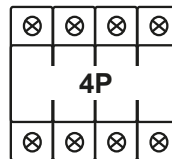
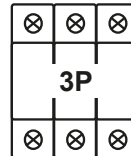

RELEVANT STANDARD
EN 60898



DC automatski osigurači za istosmjerne električne mreže

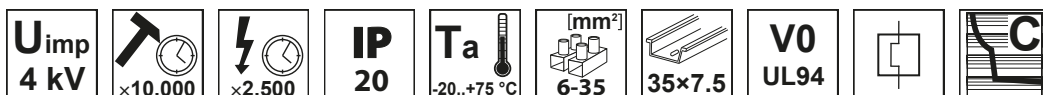

TRACON	U_i	U_e (6kV)	U_e (10kV)	I_{cu} EN 60898-2	I_{cu} EN 60947-2
DC-1C-..	500 V DC	125 V, 250 V	110 V, 220 V	6 kA	10 kA
DC-2C-..	500 V DC	250 V, 500 V	220 V, 440 V	6 kA	10 kA
DC-3C-..	1000 V DC	375 V, 750 V	330 V, 660 V	6 kA	10 kA
DC-4C-..	1000 V DC	500 V, 1000 V	440 V, 880 V	6 kA	10 kA

TRACON	I_n (A)
DC-1C-6	6
DC-1C-10	10
DC-1C-13	13
DC-1C-16	16
DC-1C-20	20
DC-1C-25	25
DC-1C-32	32
DC-1C-40	40
DC-1C-50	50
DC-1C-63	63
DC-2C-6	6
DC-2C-10	10
DC-2C-13	13
DC-2C-16	16
DC-2C-20	20
DC-2C-25	25
DC-2C-32	32
DC-2C-40	40
DC-2C-50	50
DC-2C-63	63

TRACON	I_n (A)
DC-3C-6	6
DC-3C-10	10
DC-3C-13	13
DC-3C-16	16
DC-3C-20	20
DC-3C-25	25
DC-3C-32	32
DC-3C-40	40
DC-3C-50	50
DC-3C-63	63
DC-4C-6	6
DC-4C-10	10
DC-4C-13	13
DC-4C-16	16
DC-4C-20	20
DC-4C-25	25
DC-4C-32	32
DC-4C-40	40
DC-4C-50	50
DC-4C-63	63

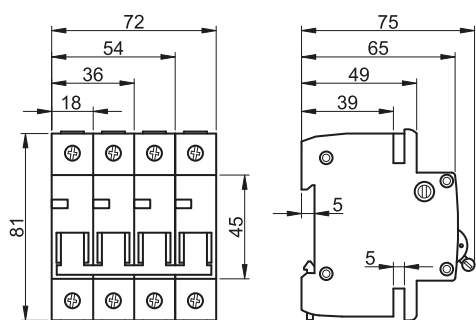

TÜV MEEI TEST DOCUMENTATION
28216230 001

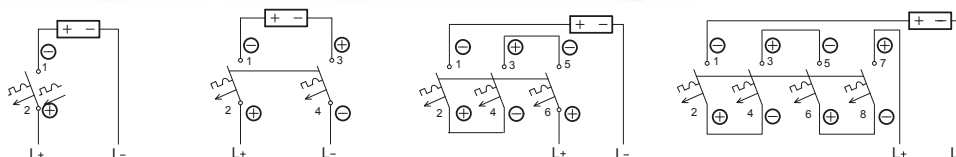

UČITAJTE ŠIFRU!

- Pogledajte naše novosti
- Budite u tijeku

Naša ponuda se brzo i kontinuirano razvija!
Katalog prikazuje stanje u travnju 2021. godine.
Za aktualne informacije posjetite našu
web stranicu!

Automatski osigurači za velike struje tipa KMH

230/400 V AC	$\times 10.000$	$\times 4.000$	IP 20	35x7.5	[mm ²] 16-35	Ta -25...+55°C	U_i 500 V	V0 UL94		I_{2t} 3	I_{cn} EN 60898 6 kA	
-----------------	-----------------	----------------	-----------------	--------	-----------------------------	--------------------------	----------------	-------------------	--	----------------------------	---	--

TRACON

C

I_n
(A)

TRACON

C

I_n
(A)

	KMH-163	63
	KMH-180	80
	KMH-1100	100
	KMH-1125	125

	KMH-363	63
	KMH-380	80
	KMH-3100	100
	KMH-3125	125

	KMH-263	63
	KMH-280	80
	KMH-2100	100
	KMH-2125	125

	KMH-463	63
	KMH-480	80
	KMH-4100	100
	KMH-4125	125

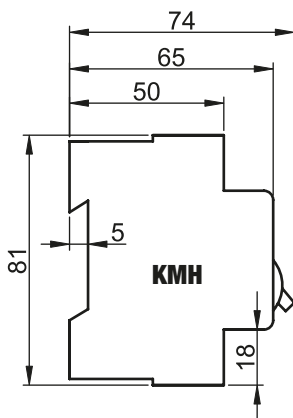
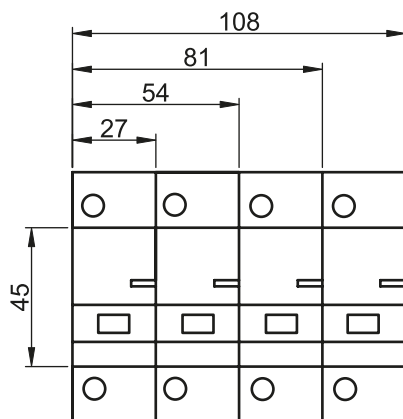
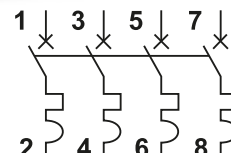
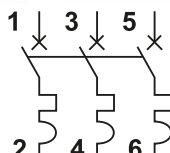
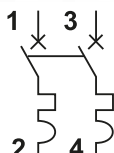

Isklopne karakteristike

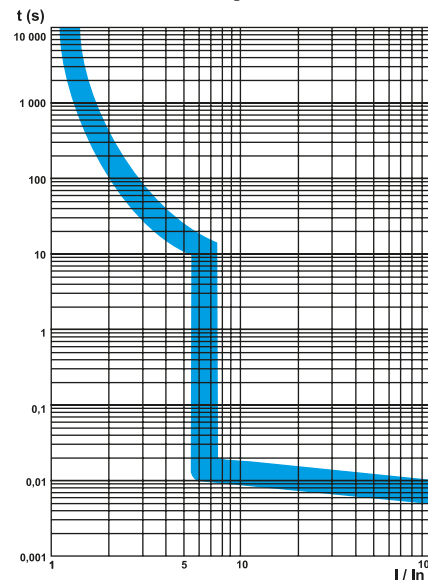

Piktogrami **F/0**

RELEVANT STANDARD
EN 60898

Kombinirana zaštitna sklopka širine 1 modula tipa KVKVE

230 V AC
 $\times 20.000$
 $\times 4.000$
IP 20
35x7.5
[mm²] 1-16
Ta -25..+55°C
U_i 690 V
V0 UL94
AC
I_{cn} EN 60898 6 kA
OFF

TRACON		I _n (A)	I Δ _n (mA)
B	C		
KVKVEB-6/30	KVKVE-6/30	6	30
KVKVEB-6/100	KVKVE-6/100	6	100
KVKVEB-10/30	KVKVE-10/30	10	30
KVKVEB-10/100	KVKVE-10/100	10	100
KVKVEB-13/30	KVKVE-13/30	13	30
KVKVEB-13/100	KVKVE-13/100	13	100
KVKVEB-16/30	KVKVE-16/30	16	30
KVKVEB-16/100	KVKVE-16/100	16	100
KVKVEB-20/30	KVKVE-20/30	20	30
KVKVEB-20/100	KVKVE-20/100	20	100
KVKVEB-25/30	KVKVE-25/30	25	30
KVKVEB-25/100	KVKVE-25/100	25	100
KVKVEB-32/30	KVKVE-32/30	32	30
KVKVEB-32/100	KVKVE-32/100	32	100

⊗

 2P

⊗

Isklopne karakteristike

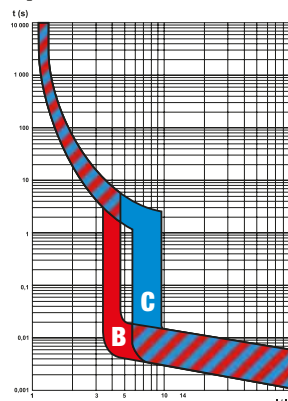

E3

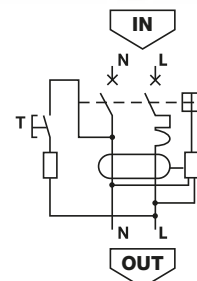
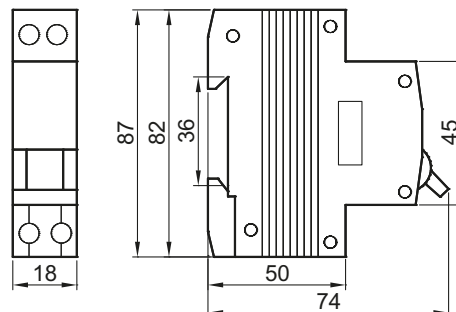

Piktogrami
 F/O

RELEVANT STANDARD
EN 61009-1

Kombinirana zaštitna sklopka tipa KVK

230 V AC
 $\times 20.000$
 $\times 4.000$
IP 20
35x7.5
[mm²] 1,0-10
Ta -25..+55°C
U_i 690 V
V0 UL94
AC
I_{cn} EN 60898 3 kA



TRACON		I _n (A)	I Δ _n (mA)
B	C		
KVKB-6/03	KVK-6/03	6	30
KVKB-6/10	KVK-6/10	6	100
KVKB-6/30	KVK-6/30	6	300
KVKB-10/03	KVK-10/03	10	30
KVKB-10/10	KVK-10/10	10	100
KVKB-10/30	KVK-10/30	10	300
KVKB-16/03	KVK-16/03	16	30
KVKB-16/10	KVK-16/10	16	100
KVKB-16/30	KVK-16/30	16	300
KVKB-20/03	KVK-20/03	20	30
KVKB-20/10	KVK-20/10	20	100
KVKB-20/30	KVK-20/30	20	300
KVKB-25/03	KVK-25/03	25	30
KVKB-25/10	KVK-25/10	25	100
KVKB-25/30	KVK-25/30	25	300
KVKB-32/03	KVK-32/03	32	30
KVKB-32/10	KVK-32/10	32	100
KVKB-32/30	KVK-32/30	32	300

⊗ ⊗

 2P

⊗ ⊗

Isklopne karakteristike

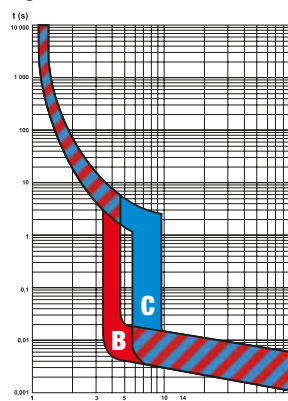

E3

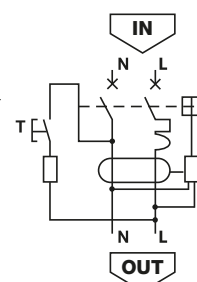
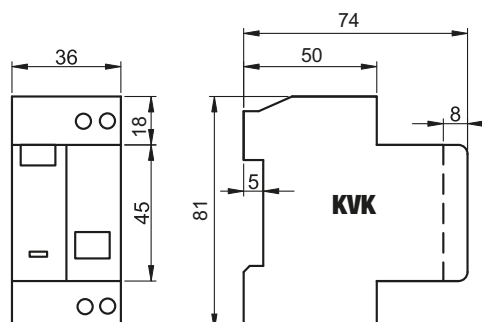

Kombinirana zaštitna sklopka tipa KVKM, elektromehanička

230 V AC
 $\times 20.000$
 $\times 4.000$
IP 20
35x7.5
[mm²] 1,5-10
Ta -25..+55°C
690 V U_i
V0 UL94
AC
I_{cn} EN 60898 6 kA
OFF

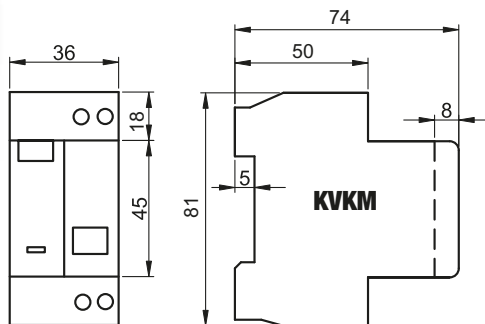
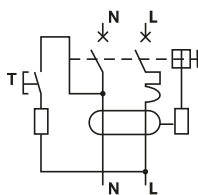

TRACON		I _n (A)	I Δ _n (mA)
B	C		
KVKMB-6/030	KVKM-6/030	6	30
KVKMB-6/100	KVKM-6/100	6	100
KVKMB-6/300	KVKM-6/300	6	300
KVKMB-10/030	KVKM-10/030	10	30
KVKMB-10/100	KVKM-10/100	10	100
KVKMB-10/300	KVKM-10/300	10	300
KVKMB-16/030	KVKM-16/030	16	30
KVKMB-16/100	KVKM-16/100	16	100
KVKMB-16/300	KVKM-16/300	16	300
KVKMB-20/030	KVKM-20/030	20	30
KVKMB-20/100	KVKM-20/100	20	100
KVKMB-20/300	KVKM-20/300	20	300
KVKMB-25/030	KVKM-25/030	25	30
KVKMB-25/100	KVKM-25/100	25	100
KVKMB-25/300	KVKM-25/300	25	300
KVKMB-32/030	KVKM-32/030	32	30
KVKMB-32/100	KVKM-32/100	32	100
KVKMB-32/300	KVKM-32/300	32	300
KVKMB-40/030	KVKM-40/030	40	30
KVKMB-40/100	KVKM-40/100	40	100
KVKMB-40/300	KVKM-40/300	40	300

Elektromehanička kombinirana zaštitna sklopka zaštitu protiv strujnog udara pruža i u slučaju prekida neutralnog vodiča!

Zaštitne strujne sklopke tipa RB

230/400 V AC
 $\times 10.000$
 $\times 4.000$
IP 20
35x7.5
[mm²] 2,5-25
Ta -25..+55°C
500 V U_i
V0 UL94
AC
I_{cn} EN 60898 4,5 kA
OFF

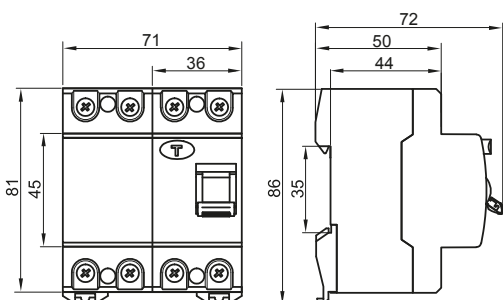

TRACON	I _n (A)	I Δ _n (mA)
RB2-25030	25	30
RB2-25100	25	100
RB2-25300	25	300
RB2-25500	25	500
RB2-40030	40	30
RB2-40100	40	100
RB2-40300	40	300
RB2-40500	40	500
RB4-25030	25	30
RB4-25100	25	100
RB4-25300	25	300
RB4-25500	25	500
RB4-40030	40	30
RB4-40100	40	100
RB4-40300	40	300
RB4-40500	40	500
RB4-63030	63	30
RB4-63100	63	100
RB4-63300	63	300
RB4-63500	63	500

Zaštitne strujne sklopke tipa TFV

TRACON	In (A)	IΔn (mA)
TFV2-16030	16	30
TFV2-16100	16	100
TFV2-16300	16	300
TFV2-25030	25	30
TFV2-25100	25	100
TFV2-25300	25	300
TFV2-40030	40	30
TFV2-40100	40	100
TFV2-40300	40	300
TFV2-63030	63	30
TFV2-63100	63	100
TFV2-63300	63	300
TFV4-16030	16	30
TFV4-16100	16	100
TFV4-16300	16	300
TFV4-25030	25	30
TFV4-25100	25	100
TFV4-25300	25	300
TFV4-40030	40	30
TFV4-40100	40	100
TFV4-40300	40	300
TFV4-63030	63	30
TFV4-63100	63	100
TFV4-63300	63	300

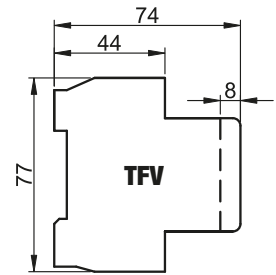
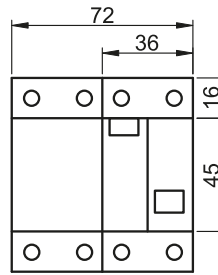
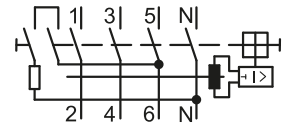
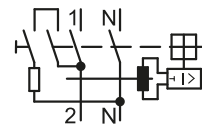
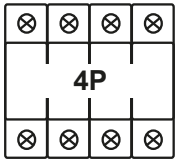
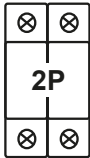

Zaštitne strujne sklopke za velike struje tipa TFVH

TRACON	In (A)	IΔn (mA)
TFVH4-80030	80	30
TFVH4-80100	80	100
TFVH4-80300	80	300
TFVH4-100030	100	30
TFVH4-100100	100	100
TFVH4-100300	100	300

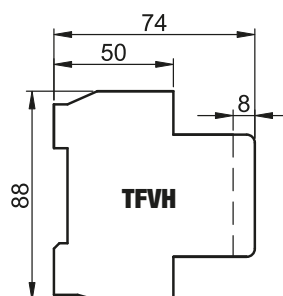
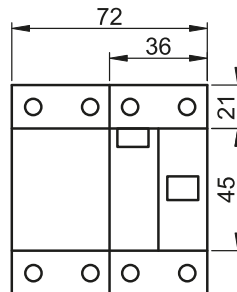
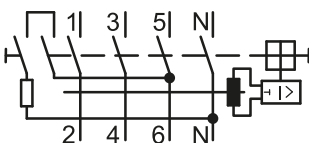
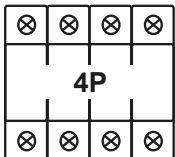

TÜV MEEI TEST DOCUMENTATION
M1 2792130 01

Zaštitne strujne sklopke tipa TFG

230/400 V AC
 $\times 10.000$
 $\times 4.000$
IP 20
35x7.5
[mm²] 2,5-25
Ta -25..+55°C
500 V U_i
V0 UL94
A, AC
I_{cn} EN 60898 6 kA
OFF

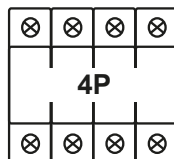
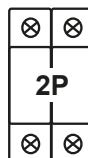
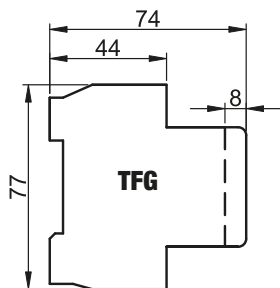
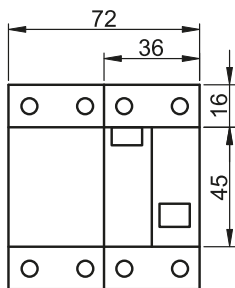
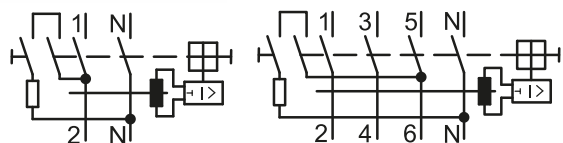

Piktogrami F/O

RELEVANT STANDARD EN 61008-1

TRACON	I _n (A)	I Δ _n (mA)
TFG2-16030	16	30
TFG2-16100	16	100
TFG2-16300	16	300
TFG2-25030	25	30
TFG2-25100	25	100
TFG2-25300	25	300
TFG2-40030	40	30
TFG2-40100	40	100
TFG2-40300	40	300
TFG2-63030	63	30
TFG2-63100	63	100
TFG2-63300	63	300
TFG4-16030	16	30
TFG4-16100	16	100
TFG4-16300	16	300
TFG4-25030	25	30
TFG4-25100	25	100
TFG4-25300	25	300
TFG4-40030	40	30
TFG4-40100	40	100
TFG4-40300	40	300
TFG4-63030	63	30
TFG4-63100	63	100
TFG4-63300	63	300

Adapter sa zaštitnom strujnom sklopkom tipa TFGA

TRACON		I _n (A)	I Δ _n (mA)	P _{max}	IP..
TFGA-1		16	30	3.600 W	IP 40
TFGA-1F		16	30	3.600 W	IP 40
TFGA-4F		16	30	3.600 W	IP 44



230 V AC
Ta -25..+55°C
500 V U_i
 $\times 20.000$
A, AC
V0 UL94
I_{cn} EN 60898 6 kA

U mrežama sa zaštitnim vodičem adapter sa zaštitnom strujnom sklopkom tipa TFGA je najsuvremenija naprava za zaštitu od indirektnog dodira, a u nekim slučajevima omogućuje zaštitu i od direktnog dodira. Zaštitna sklopka automatski isklopi čim struja greške u šticejnoj mreži dostigne kritičnu vrijednost. Budući da je adapter u prijenosnoj izvedbi, pogodan je za uporabu u svim mrežama u kojima nije ugrađena zaštitna strujna sklopka.

Napravu možemo aktivirati pritiskom na tipkalo RESET. Ispravnost naprave prije prve uporabe treba provjeriti pritiskom na tipkalo TEST, pri čijem će djelovanju adapter utičnicu isključiti iz mreže. U slučaju stalne uporabe ispravnost uređaja treba provjeriti mjesečno barem jedanput, također pritiskom na tipkalo TEST. Nakon uključjenja adaptera treba šticejnu mrežu (uređaj) uključiti u utičnicu adaptera.

TÜV MEEI TEST DOCUMENTATION M1 2792130 01

ETL-SEMKO CERTIFICATE NO. 630406

Zaštitna strujna sklopka s motornim automatom za ponovno uklapanje

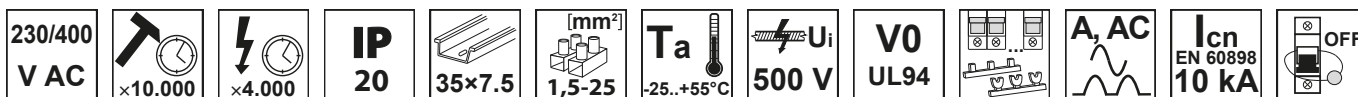

		TRACON			I _n (A)
		I _{Δn} = 30 mA	I _{Δn} = 100 mA	I _{Δn} = 300 mA	
		TFIG2-16030	TFIG2-16100	TFIG2-16300	16
		TFIG2-25030	TFIG2-25100	TFIG2-25300	25
		TFIG2-40030*	TFIG2-40100*	TFIG2-40300	40
		TFIG2-63030	TFIG2-63100	TFIG2-63300	63
		TFIG4-16030	TFIG4-16100	TFIG4-16300	16
		TFIG4-25030	TFIG4-25100	TFIG4-25300	25
		TFIG4-40030	TFIG4-40100*	TFIG4-40300	40
		TFIG4-63030	TFIG4-63100	TFIG4-63300*	63
	TFIG4-80030	TFIG4-80100	TFIG4-80300	80	



* ima u skladištu, a ostale inačice po posebnoj narudžbi s rokom isporuke od 4 tjedna

Aparat je namijenjen za ponovno uklapanje strujnog kruga nakon isklapanja uslijed pojave povećane struje greške ili nadstruje od atmosferskih pražnjenja, kada se u strujnom krugu struja greške smanji na odgovarajuću razinu.

Uporaba ovog proizvoda se preporučuje na mjestima, gdje isklapanje zaštitne naprave uzrokuje prekid u radu koji zbog udaljenosti osoblja za rukovanje može predugo trajati (telekomunikacijske postaje, upravljački ormari za prometnu signalizaciju, udaljeni sklopni aparati). Greška koja uzrokuje isklapanje često brzo nestaje i tada zastoj nije opravdan, te uzrokuje znatne gubitke.

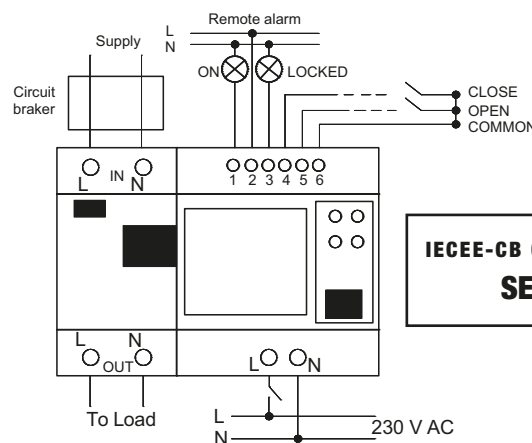

IECEE-CB CERTIFICATE NO.
SE-58939

Montiranje i postavljanje automata može se izvesti jednostavno, za odabir automatskog rada dovoljno je samo izbočeni poklopac na prednjoj ploči povući u stranu.

Ukoliko aparat tijekom određenog broja ponovnih uklapanja (1-8) ne uspije uključiti zaštitnu strujnu sklopku, ona će ostati isključena. Nakon povratka ispravnog stanja na mrežu zaštitna strujna sklopka se može i ručno uključiti. U slučaju održavanja prije isključivanja strujnog kruga kliznu sklopku na prednjoj ploči treba postaviti u položaj OFF (ISK), inače će se aparat automatski uključiti! U slučaju posebnog zahtjeva radi sprječavanja neželjenih uključivanja može se naručiti inačica sa zaključavanjem.

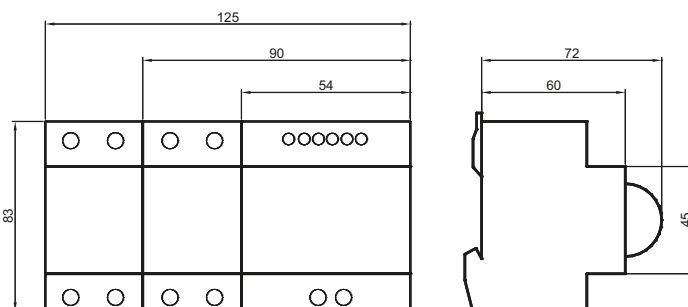

Tehnički parametri	Zaštitna strujna sklopka	Motorni automat za ponovno uklapanje
Postavljanje broja ponovnih uklapanja	–	1, 2, 4, 6, 8
Vrijeme okidanja / isklapanja	0,1 s	1 s
Vrijeme uklapanja	–	2 s
Vrijeme kašnjenja ponovnog uklapanja	–	10 – 30 – 60 – 120 – 180 s
LED indikator rada u tijeku je ponovno uklapanje	–	zeleno: UKL, crveno: ISK, isprekidano crveno:
Ručno isključivanje-uključivanje	ručkom	izbočenom kliznom sklopkom
Opreteivost pomoćnog kontakta	–	250 V AC, 5 A
Ulaz za daljinsko upravljanje	–	NC / NO / CO

Instalacijski sklopnici (kontaktori)

230/400 V AC			IP 20			Ta -25...+55°C		V0 UL94			F/O
-----------------	--	--	--------------	--	--	--------------------------	--	-------------------	--	--	------------

TRACON	U _m	I _n (A)	W (mm)	P _e (kW)				P _s			NC NO	
				AC1/AC7a 230V	AC3/AC7b 230V	AC1/AC7a 400V	AC3/AC7b 400V					
SHK2-25	230 V AC	25	18	5 kW	1,5 kW	-	-	1,35 W	20A gG	2 × NO	1-6	
SHK2-25V11	230 V AC	25	18	5 kW	1,5 kW	-	-	1,35 W	20A gG	1 × NO+1 × NC	1-6	
SHK2-25-24	24 V AC	25	18	5 kW	1,5 kW	-	-	1,35 W	20A gG	2 × NO	1-6	
SHK2-40	230 V AC	40	36	9 kW	2,2 kW	-	-	1,55 W	32A gG	2 × NO	2,5-25	
SHK2-40V11	230 V AC	40	36	9 kW	2,2 kW	-	-	1,55 W	32A gG	1 × NO+1 × NC	2,5-25	
SHK2-63	230 V AC	63	36	14 kW	5,5 kW	-	-	1,55 W	50A gG	2 × NO	2,5-25	
SHK2-63V11	230 V AC	63	36	14 kW	5,5 kW	-	-	1,55 W	50A gG	1 × NO+1 × NC	2,5-25	
SHK3-25	230 V AC	25	36	5 kW	1,5 kW	9,5 kW	3,4 kW	1,35 W	20A gG	3 × NO	1-6	
SHK3-40	230 V AC	40	54	9 kW	2,2 kW	16 kW	4 kW	1,55 W	32A gG	3 × NO	2,5-25	
SHK3-63	230 V AC	63	54	14 kW	5,5 kW	24 kW	9 kW	1,55 W	50A gG	3 × NO	2,5-25	
SHK4-25	230 V AC	25	36	5 kW	1,5 kW	9,5 kW	3,4 kW	1,35 W	20A gG	4 × NO	1-6	
SHK4-25V22	230 V AC	25	36	5 kW	1,5 kW	9,5 kW	3,4 kW	1,35 W	20A gG	2 × NO+2 × NC	1-6	
SHK4-40	230 V AC	40	54	9 kW	2,2 kW	16 kW	4 kW	1,55 W	32A gG	4 × NO	2,5-25	
SHK4-40V22	230 V AC	40	54	9 kW	2,2 kW	16 kW	4 kW	1,55 W	32A gG	2 × NO+2 × NC	2,5-25	
SHK4-63	230 V AC	63	54	14 kW	5,5 kW	24 kW	9 kW	1,55 W	50A gG	4 × NO	2,5-25	
SHK4-63V22	230 V AC	63	54	14 kW	5,5 kW	24 kW	9 kW	1,55 W	50A gG	2 × NO+2 × NC	2,5-25	
SHK2-25K	230 V AC	25	18	5 kW	1,5 kW	-	-	1,35 W	20A gG	2 × NO	1-6	
SHK2-40K	230 V AC	40	36	9 kW	2,2 kW	-	-	1,55 W	32A gG	2 × NO	2,5-25	
SHK2-63K	230 V AC	63	36	14 kW	5,5 kW	-	-	1,55 W	50A gG	2 × NO	2,5-25	
SHK4-25K	230 V AC	25	36	5 kW	1,5 kW	9,5 kW	3,4 kW	1,35 W	20A gG	4 × NO	1-6	
SHK4-40K	230 V AC	40	54	9 kW	2,2 kW	16 kW	4 kW	1,55 W	32A gG	4 × NO	2,5-25	
SHK4-63K	230 V AC	63	54	14 kW	5,5 kW	24 kW	9 kW	1,55 W	50A gG	4 × NO	2,5-25	

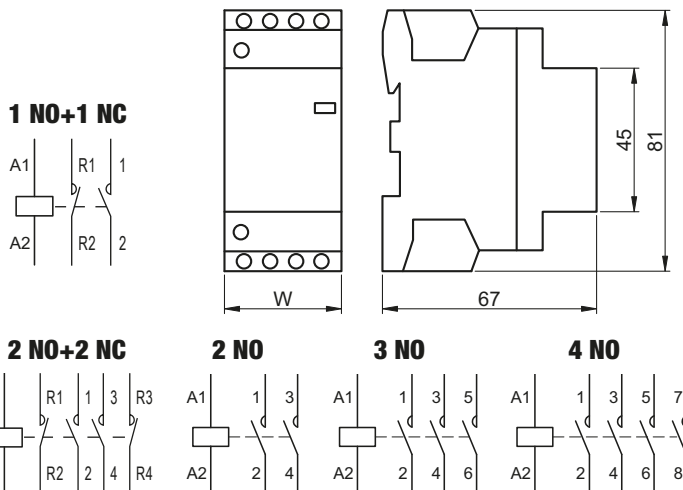

Pomoćni kontakt za SHK kontaktore

TRACON	U _m	I _n (A)	W (mm)	AC12 (230V)	AC15 (230V)	DC13 (130V)		NC NO	
SHK-S11	230 V AC	5 A	9 mm	5 A (AC12)	2 A (AC15)	1 A	1 × NO + 1 × NC	1-6 mm ²	
SHK-S20	230 V AC	5 A	9 mm	5 A (AC12)	2 A (AC15)	1 A	2 × NO	1-6 mm ²	

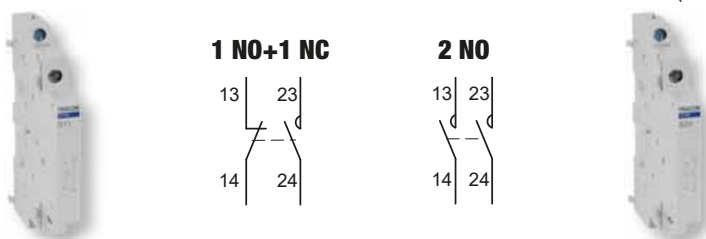

Stubišni automat (vremenska sklopka)

230 V AC	[mm²] 1-2,5	IP 20	T_a -20...+55°C	35x7.5	AUX 1xCO	x40.000	U_i 500 V	V0 UL94	Piktogrami	F/0
-----------------	----------------------------------	--------------	-------------------------------------	---------------	--------------------	----------------	-------------------------------	----------------	-------------------	------------

TRACON		P _s	I _n	L	Σ	P _{max}	
TLA-3	30 sec – 12 min	1 VA	16 A (cos φ = 1)	max. 250 m	max. x 50	max. 2.300 W	max. 800 W
NARS	30 sec – 20 min	1.5 VA	16 A (cos φ = 1)	max. 250 m	max. x 50	max. 2.000 W	max. 400 W

Primjena
- Zakašnjelo isključivanje rasvjete na hodnicima, ulazima, stubištima, dvoranama, halama ili ventilatora (WC, kupaoonica, itd.)

RELEVANT STANDARD
EN 60730

RELEVANT STANDARD
EN 60669-2

3-žično spajanje

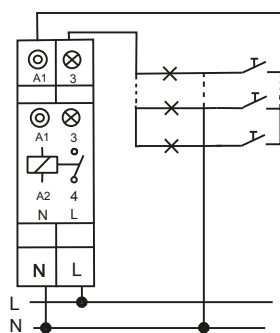

4-žično spajanje

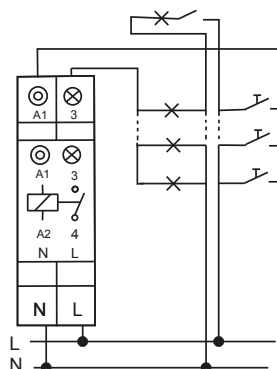

3-žično spajanje

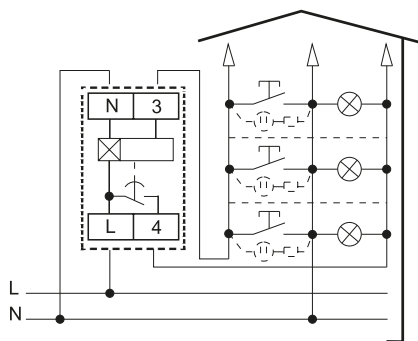

4-žično spajanje

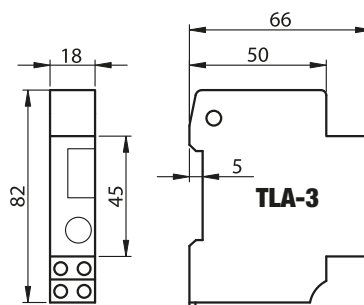
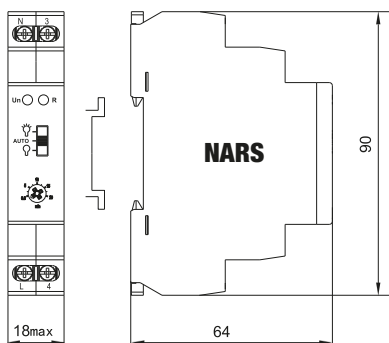
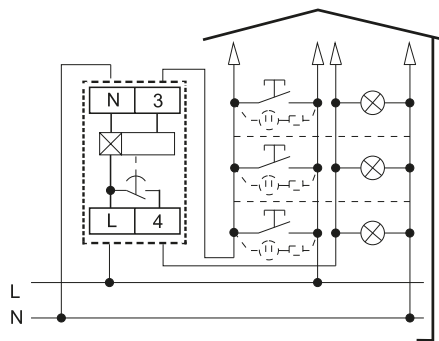

UČITAJTE ŠIFRU!

- Pogledajte naše novosti
- Budite u tijeku

Naša ponuda se brzo i kontinuirano razvija!
 Katalog prikazuje stanje u travnju 2021. godine.
 Za aktualne informacije posjetite našu web stranicu!

Impulsni relej

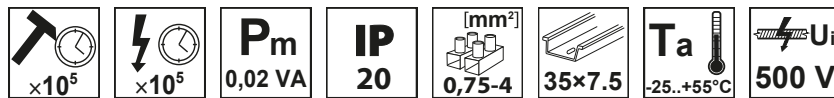

TRACON	Um	Pmax		cosφ=1	cosφ=0,6
IMP-12	12 V AC	max. 3.500 W	max. 1.300 W	× 100.000	× 50.000
IMP-24	24 V AC	max. 3.500 W	max. 1.300 W	× 100.000	× 50.000
IMP-230	230 V AC	max. 3.500 W	max. 1.300 W	× 100.000	× 50.000
NARIMP	AC/DC12V-240V	max. 2.000 W	max. 900 W	× 500.000	× 250.000



IMP-..

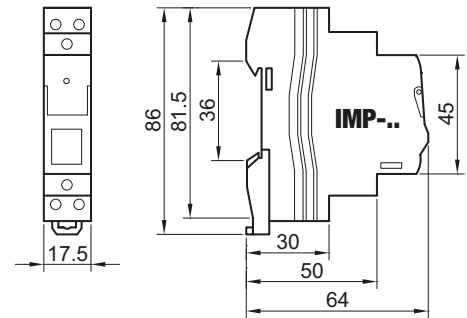
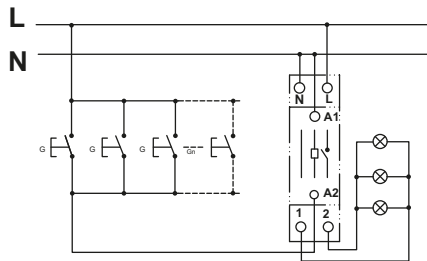

Primjena

- Impulsni relej može se upravljati tipkalicima s raznih mjesta. Zahvaljujući tome može zamijeniti križne sklopke (praktično bez ograničenja priključen na dva paralelna vodiča). Za instalatera je instaliranje preglednije i brže.



NARIMP

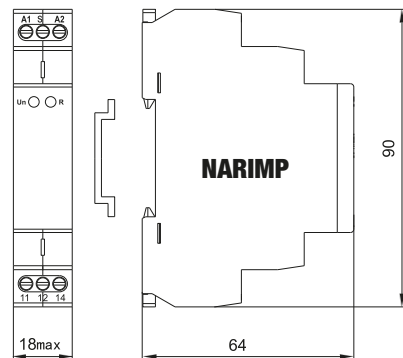
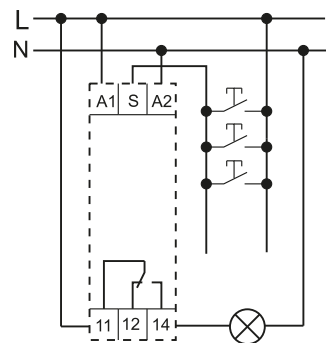

Signalna zvonca

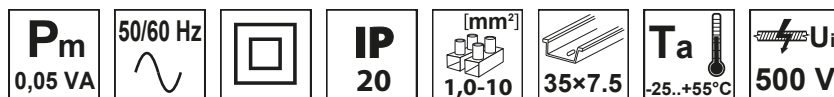

TRACON	Um		
C60-CSEN	230 V AC	60 dB	max. 60 min.
C60-CSEN-24	24 V AC	60 dB	max. 60 min.
C60-CSEN-12	12 V AC	60 dB	max. 60 min.
C60-CSEN-8	8 V AC	60 dB	max. 60 min.

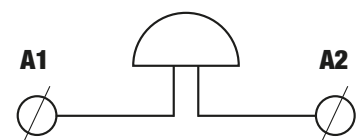
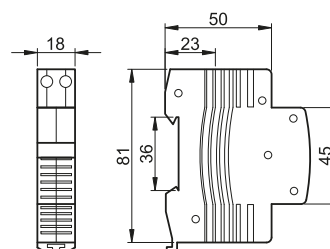

Sigurnosni transformator (za zvonca)

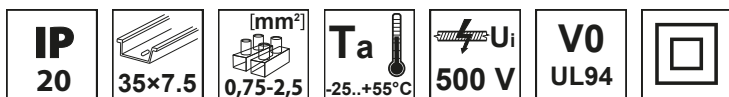

TRACON	P_s	U_{pr}	U_{sec}	I_{sec}
BT-8/1	max. 8 VA	230 V AC	4, 8, 12 V AC	0,66 A
BT-8/2			8, 12, 24 V AC	0,33 A

Malonaponski, sigurnosni transformator za razdvajanje. Daje mali napon u svrhu zaštite od dodira. Osim za napajanje zvona, može poslužiti i za druge svrhe odgovarajuće snage, npr. za napajanje elektroničkih sklopova.

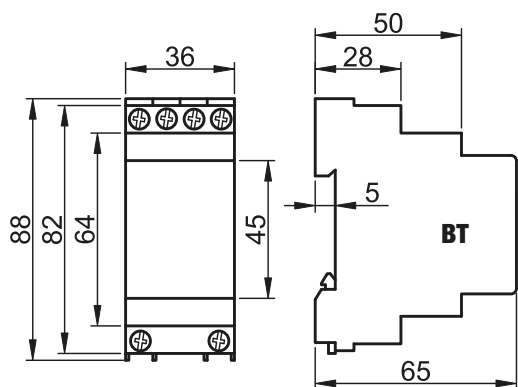

RELEVANT STANDARD
EN 61558-2-8

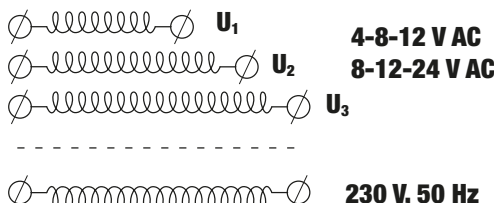

Priključnice za redanje

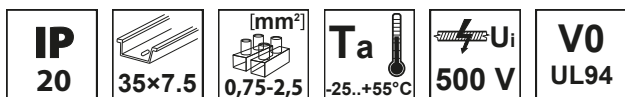

TRACON		I_n (A)	U_n
C60-DA0	2P+	16	250 V AC
C60-DA	2P+	16	250 V AC

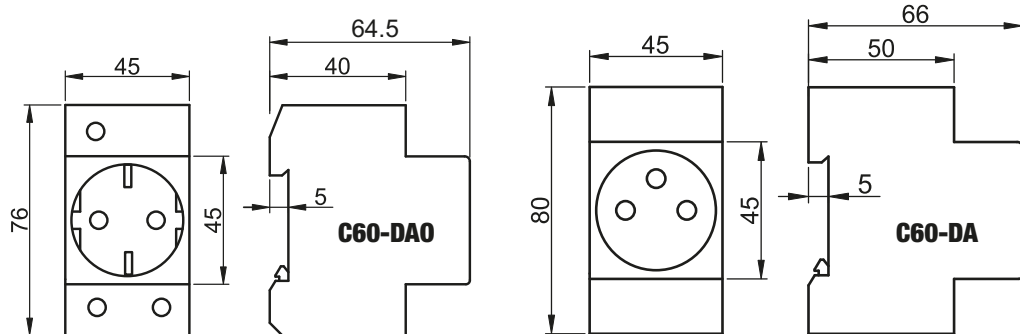

RELEVANT STANDARD
MSZ 9872

RELEVANT STANDARD
IEC 60884-1























TÜV MEEI TEST DOCUMENTATION
28208191 001

Nadžbukna sklopka i utičnica tipa TP-RH

230 V AC	V1 UL94	IP 54	[mm²] 1-2,5	Ta -25...+55°C	U_i 500 V
--------------------	-------------------	-----------------	----------------------------------	--------------------------	-------------------------------

 **Piktogrami** **F/0**



TRACON		 SHUKO	 FRENCH	
TR-PH01		×1	–	–
TR-PH02		×2	–	–
TR-PHF02		–	×2	–
TR-PH03		×1	–	101
TR-PHF03		–	×1	101
TR-PH08		×1	–	106
TR-PHF08		–	×1	106
TR-PH11		×1	–	102
TR-PH03V		×1	–	101
TR-PHF03V		–	×1	101
TR-PH08V		×1	–	106
TR-PHF08V		–	×1	106
TR-PH09V		×1	–	2×101
TR-PHF09V		–	×1	2×101
TR-PH10V		×1	–	2×106
TR-PHF10V		–	×1	2×106
TR-PH09		×1	–	2×101
TR-PHF09		–	×1	2×101
TR-PH10		×1	–	2×101
TR-PHF10		–	×1	2×101
TR-PH04		–	–	102
TR-PH05		–	–	101
TR-PH05L*		–	–	101
TR-PH06		–	–	106
TR-PH06L *		–	–	106
TR-PH07		–	–	N101
TR-PH07L*		–	–	N101
TR-PH05-2		–	–	2×101
TR-PH06-2		–	–	2×106

* s indikatorom

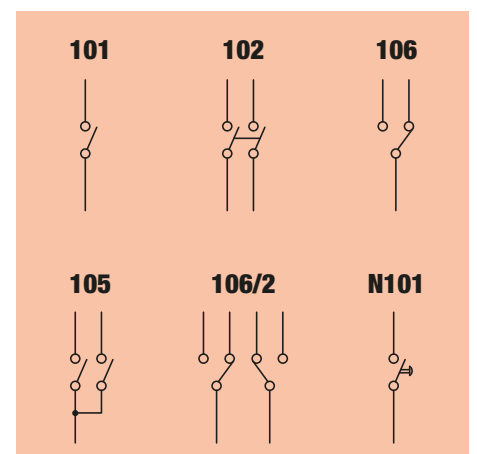
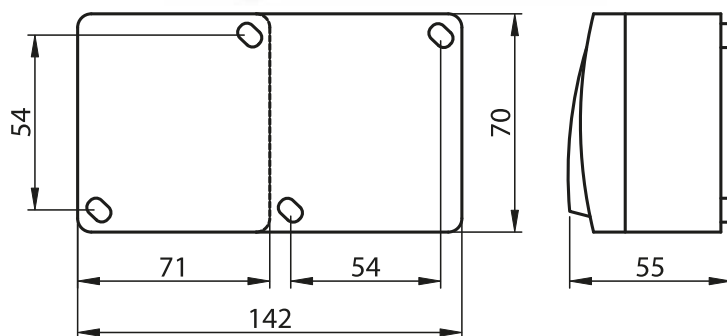

RELEVANT STANDARD
EN 60669-1







TÜV MEEI TEST DOCUMENTATION
28208176 001

Nadžbukna sklopka i utičnica tipa TTK









230 V AC	V1 UL94	IP 20	[mm²] 1-2,5	Ta -25..+55°C	U_i 500 V
--------------------	-------------------	-----------------	----------------------------------	-------------------------	-------------------------------

 **Piktogrami** **F/0**





TRACON

TTK-11	TTK-12	TTK-13*	TTK-21	TTK-31	TTK-32
					
SCHUKO	FRENCH	NO EARTH*	(RJ11 6/4) Telephone	9,5 mm TV	9,5 mm TV+FM

TRACON

TTK-01	TTK-02	TTK-03	TTK-04B	TTK-04L	TTK-04W	TTK-05	TTK-06	TTK-07
								
101	106	102	N101	N101	N101	2x101	105	2xN101

* Samo za stare instalacije, za zamjenu dotrajalih utičnica!

101 	102 	105 	106 	N101 
---	---	---	---	--

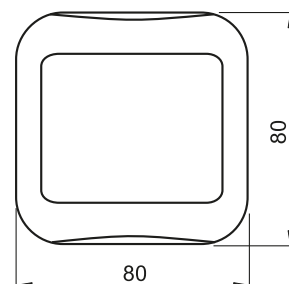

RELEVANT STANDARD
EN 60669-1

RELEVANT STANDARD
IEC 60884-1

RELEVANT STANDARD
MSZ 9871-2

TÜV MEEI TEST DOCUMENTATION
28208176 001

Nadžbukna sklopka i utičnica tipa TFK



230 V AC	V1 UL94	IP 20	[mm ²] 1-2,5	Ta -25..+55°C	U _i 500 V	50/60 Hz
-------------	------------	----------	-----------------------------	------------------	-------------------------	----------

TRACON

TFK101	TFK101B	TFK102	TFK105	TFK106	TFKSCH	TFKSCH-2	TFKSCH-3
× 1 10 AX/250 V IP 20, (101)	× 1 10 AX/250 V IP 20, (N101)	× 1 10 AX/250 V IP 20, (102)	× 1 10 AX/250 V IP 20, (2×101)	× 1 10 AX/250 V IP 20, (106)	× 1 16 A/250 V, IP 20	× 2 16 A/250 V, IP 20	× 3 16 A/250 V, IP 20



TFK101B



TFK102



TFK105



TFKSCH



TFKSCH-2



TFKSCH-3

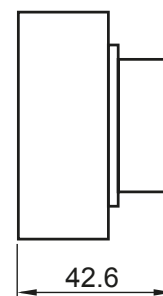
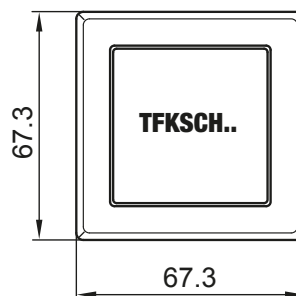
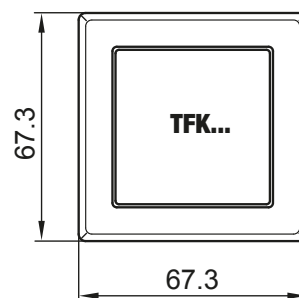

Podžbukna utičnica s USB portom

230 V AC	V1 UL94	IP 20	[mm ²] 1-2,5	Ta -25..+55°C	U _i 500 V	50/60 Hz
-------------	------------	----------	-----------------------------	------------------	-------------------------	----------

TRACON

USB-21



× 1
16 A/250 V,
IP 20

USB:5V, 2100mA



SCHUKO + USB

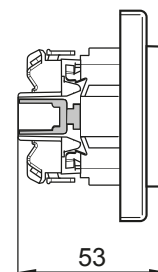
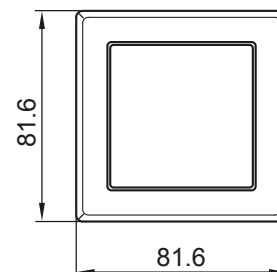

Bežično zvono









Ta 
-20...+45°C

IP
44



Piktogrami

F/0

TRACON			A ← L → B						
BELLW1-1V1	3×AA	1×CR2032	100 m	82 dB	10	✓	✓	1 kom.	1 kom.
BELLW1-1V2	3×AA	1×CR2032	100 m	82 dB	10	✓	✓	1 kom.	2 kom.
BELLW1-2V1	3×AA	1×CR2032	100 m	82 dB	10	✓	✓	2 kom.	1 kom.
BELLW2-2V1	3×AA	1×CR2032	100 m	82 dB	10	✓	✓	2 kom.	1 kom.
BELLW3-1V1	2×AA	1×CR2032	100 m	82 dB	32	-	-	1 kom.	1 kom.
BELLW4-1V1	230 V AC	kinetičke tipkalo	100 m	82 dB	16	✓	✓	1 kom.	1 kom.
BELLW5-1V1	230 V AC	kinetičke tipkalo	100 m	82 dB	16	✓	✓	1 kom.	1 kom.



**BELLW1-1V1,
BELLW1-1V2,
BELLW1-2V1**



BELLW3-1V1



BELLW2-2V1



BELLW4-1V1



BELLW5-1V1

Školsko zvono

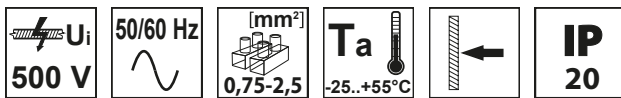

TRACON	Um	In		[h]	H (mm)	W (mm)	D ₁ (mm)	D ₂ (mm)	d (mm)
BELL8S	8 V AC	0,33 A	65 dB	max. 60 min.	148	72	36	36	76
BELL8	8 V AC	0,55 A	85 dB	max. 60 min.	220	124	47	61	120
BELL24	24 V AC	0,17 A	85 dB	max. 60 min.	220	124	47	61	120
BELL230	230 V AC	0,03 A	85 dB	max. 60 min.	220	124	47	61	120



BELL8, BELL24, BELL230

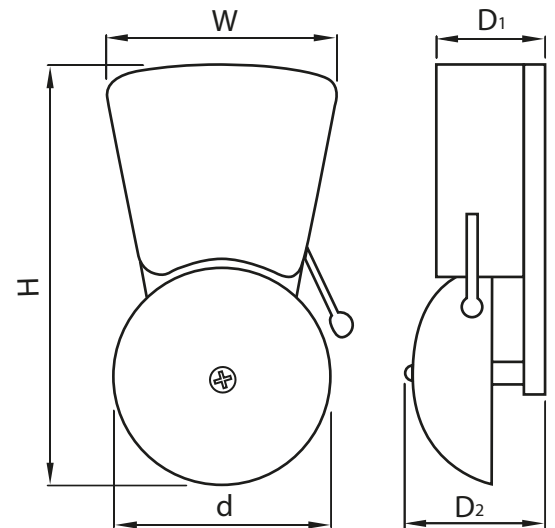

LV

VODOTIJESNE LED SVJETILJKE

TRACON ELECTRIC®

E/58

VF ventilatori za kupaonice



Rešetkasta prednja ploča (VF)

TRACON			 0, rel. % 40-100	 1s-12min	A (mm)	B (mm)	C (mm)	D (mm)	
VF100-B	✓	—	—	—	161×161	22	55	98	100 mm
VF100-BT	✓	—	—	✓	161×161	22	55	98	100 mm
VF100-BTS	✓	✓	—	✓	161×161	22	55	98	100 mm
VF100-BTSH	✓	✓	✓	✓	161×161	22	55	98	100 mm

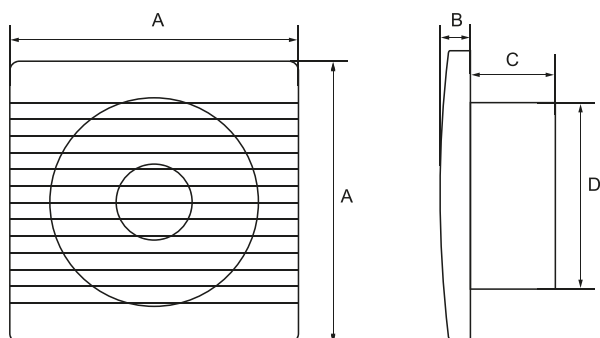

15 W

33 dB

80 m³/h



VF...

Prednja ploča s automatskom žaluzinom (VFM)

TRACON			 0, rel. % 40-100	 1s-20min	A (mm)	B (mm)	C (mm)	D (mm)	
VFM100-B	✓	—	—	—	150×150	50	42	98	100 mm
VFM100-BT	✓	—	—	✓	150×150	50	42	98	100 mm
VFM100-BTH	✓	—	✓	✓	150×150	50	42	98	100 mm

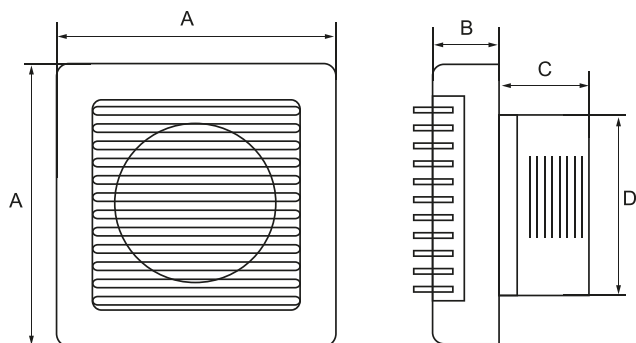

15 W

33 dB

80 m³/h



VFM...

Vanjske rešetke

TRACON	A (mm)	B (mm)	Ø D (mm)
VFG100	151	45	96
VFS100	151	45	96

	VF100-B	kuglični ležaj
	VF100-BT	žaluzina
	VF100-BTS	relativna vlažnost
	VF100-BTSH	timer

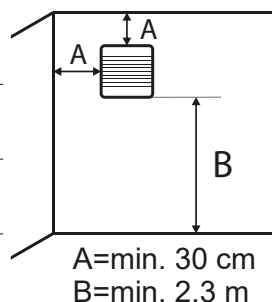

VFG100



VFS100

Senzor ugljičnog monoksida

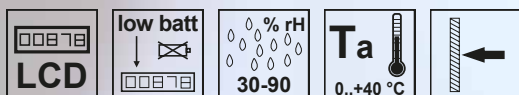

Koncentracija CO plina	30 ppm	50 ppm	100 ppm	300 ppm
Prema normi EN 50291	Nema uzbunjivanja	60 - 90 min.	10 - 40 min.	<3 min.
Mjerni rezultati iz zapisnika TÜV SÜD R-546875	Nema uzbunjivanja	66 - 71 min.	26 - 33 min.	64 - 85 s
Mjerni rezultati iz zapisnika Szenzortechnika d.o.o. G/265/2015	Nema uzbunjivanja	71 - 72 min.	20 min.	31 - 50 s

Senzor kompaktnih dimenzija je namijenjen za detekciju otrovnog, bezbojnog i bezmirisnog ugljičnog monoksida u zraku stambenih prostorija. Ugljični monoksid uslijed nepotpunog izgaranja može iz neispravnih grijaćih uređaja dospjeti u prostorije i prouzročiti gušenje, čak sa smrtnom posljedicom. Ukoliko koncentracija plina prelazi postavljenu vrijednost, senzor uzbunjuje u 4 koraka svjetlosnim i zvučnim signalom, štiteći tako zdravlje i život prisutnih u stanu. Aparat međutim ne štiti od kroničnih utjecaja ugljičnog monoksida i ne pruža potpunu zaštitu od specijalnih rizika! Uporaba ovog proizvoda ne može zamijeniti stručno instaliranje i održavanje grijaćih uređaja, te odgovarajuće provjetranje!

Senzorski element:	elektrokemijska ćelija
Napajanje:	3 baterije 1,5 V AA
Utrošak struje:	mirno stanje: <80 μ A uzbunjivanje: 0,4 - 1,5 mA
Vrsta uzbunjivanja:	svjetlosni i zvučni signal
Pokazivanje (LCD):	osnovna pozicija: PPM, vanjska temperatura, stanje baterije uzbunjivanje/test: ERR – greška; --- - test; HCO – visoka razina CO
Optičko pokazivanje (LED):	rad (zeleno), greška (žuta), uzbunjivanje (crveno)
Vrijeme spremnosti za rad:	5 s
Ugrađeno ispitno dugme	

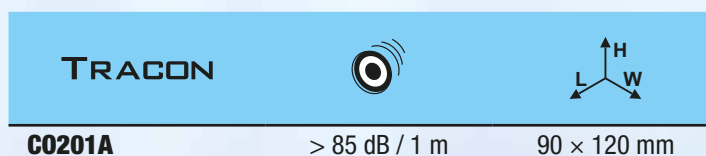

TRACON
ELECTRIC®



Vijek trajanja senzorske jedinice je 7 godina od prvog puštanja u pogon. U senzoru postoji opcija za pokazivanje „kraja vijeka trajanja“.



Izbjegnite nesreću!

Bežični senzor dima s mogućnošću dojavljivanja

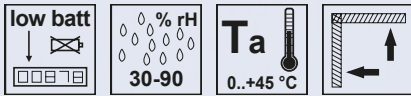

TRACON



Hz



SD101LD > 85 dB / 3 m 433,92 MHz Ø125 × 125 × 48 mm

Bežični senzori kompaktnih dimenzija su namijenjeni za detekciju dima u prostorijama, te se izvrsno primjenjuju za protupožarnu zaštitu ljudi i imovine. Aparat uzbunjuje zvučnim signalom i daljinski dojavljuje prema odgovarajućem prijatelju već pri neznatnoj količini dima, prema tome dojavom može signalizirati nastanak dima i u zatvorenim prostorijama.

Napajanje: 3 baterije 1,5 V AA (odašiljač)
1 baterija 9 V 6LR61 (senzor)

Vrsta uzbunjivanja: svjetlosni i zvučni signal

Utrošak struje: mirno stanje (9 V): <12 µA
uzbunjivanje (9 V): <20 mA
signaliziranje (4,5 V): <230 µA

Ugrađeno ispitno i edukacijsko dugme



RELEVANT STANDARD
EN 14604:2005



Bežični senzor dima bez mogućnosti dojavljivanja

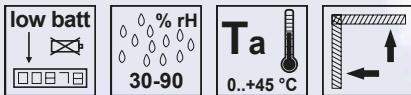

TRACON



SD133A > 85 dB / 3 m 103×103×35 mm

Rad ovog senzora jednostavnije izvedbe je identičan prethodnom tipu, međutim nema funkciju bežičnog dojavljivanja.

Napajanje: 1 baterija 9 V 6LR61 (senzor)

Vrsta uzbunjivanja: svjetlosni i zvučni signal

Utrošak struje: mirno stanje (9 V): <12 µA
uzbunjivanje (9 V): <20 mA
signaliziranje (4,5 V): <230 µA

Ugrađeno ispitno i edukacijsko dugme



RELEVANT STANDARD
EN 14604:2005



DETALJNI PARAMETRI PROIZVODA MOGU SE NAĆI U NAŠOJ WEB TRGOVINI!