



Rozdzielnice natynkowe, seria EDFK 2



Rozdzielnice podtynkowe, seria EDS 2



Natynkowe rozdzielnice z płaskimi drzwiami, seria EDFKS 3



Podtynkowe rozdzielnice z płaskimi drzwiami, seria EDSS 4

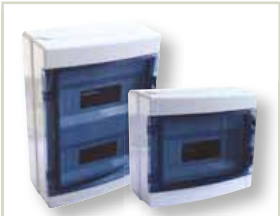

Natynkowe rozdzielnice IP 65 6



Skrzynki rozdzielcze bez drzwi 6



Skrzynki rozdzielcze bez drzwi, plombowania 7



Obudowy urządzeń modułowych 7



Plastikowe rozdzielnice natynkowe TME 8



Natynkowe rozdzielnice metalowe 9



Natynkowe rozdzielnice metalowe, seria EDFKF 9



Szafy metalowe maskowane, seria TFE 10



Metalowa osłona przeciwdeszczowa do szaf rozdzielczych 10



Metalowe skrzynki rozdzielcze, seria TFE 11



Drzwi dostępne z osłoną 12



Ścianki wentylacyjne 12



Plastyczny zamek do rozdzielnic metalowych 13



Uchwyt do projektów 13



Przepust kablowy do rozdzielnic 13



Metalowe rozdzielnice ze szklanymi, zaokrąglonymi drzwiami, seria TGE 14



Rozdzielnice metalowe, drzwi metalowe, seria TGEF 15



Wentylatory z filtrem 18



Grzejniki kompaktowe do rozdzielnic z wentylatorem 19



Grzejniki kompaktowe do rozdzielnic z wentylatorem 19



Termostat (Regulator temperatury) 20



Higrostat 20

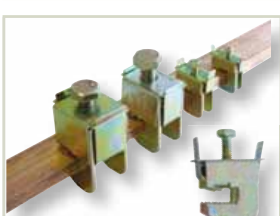

Odgałęźniki do szyn prądowych 20







































Regulowane uchwyty do kabli 21



























Izolatory wsporcze 21

Spis piktogramów w nagłówkach

 Un Napięcie znamionowe (V)	 In Prąd znamionowy (A)	 Pmax Maks. Obciążenie	 Otwór wycięcia
 Uwagi, uzupełnienia	 Głośność	 Zakres ustawień	 Zakres ustawień
 P_{th} Moc grzewcza	 Th Temperatura elementu grzewczego	 m³/h Wydajność	 ×17,5mm Σs Rzędy×moduły
 Przyciemniane drzwi	 Białe drzwi	 Drzwi przeźroczyste	 Skrzynki rozdzielcze bez drzwi
 Szafy zawierają szyny N i PE	 Zamki (szt.)	 ×17.5 Liczba modułów	 VDC VAC A Parametry elektryczne styków
 M Gwint	 (N) F_a Rozciąganie	 F_b (N) Zginanie	 Nm Moment dokręcania
 Kolor	 × Wejścia	 Długość	 Przekrój podłączanego przewodu mm²
 Rozmiar podłączanych przewodów	 m Masa	 ml Objętość	 Rozmiar otworu
 H L W Wymiary	 d Szyna miedziana	 Grubość płyty	 AUX Styki pomocnicze
 (mm) Rozmiar szyny (mm)			

Spis piktogramów w danych technicznych

 600/1000 V AC/DC Napięcie znamionowe (V)	 In max. 250 A Prąd znamionowy (A)	 U_i 1 kV Znamionowe napięcie izolacji	 Utest 1min 5 kV Napięcie próbne
 U_i 690 V Maks. napięcie izolacji montowanych urządzeń:	 IP 65 Stopień ochrony	 I. klasa ochrony dotykowej	 II. klasa ochrony dotykowej
 ABS Materiał: ABS	 Cu Materiał: Z miedzi	 STEEL Materiał: stal	 Al Materiał: aluminium
 Szafy zawierają szyny N i PE	 Kąt otwarcia drzwi	 35×7.5 Montaż na szynę TH35	 Montaż fundament betonowy
 Sposób montażu: pionowy	 [mm²] 1,5-2,5 Rozmiar podłączanych przewodów	 AUX 1×CO Styki pomocnicze	 IK08 Odporność uderowa
 V2 UL94 Niepalność zgodnie z UL94	 Ta Temperatura otoczenia -20...+80°C	 UV Odporność UV	 Łożysko kulkowe
 Możliwość plombowania			

Rozdzielnice natynkowe, seria EDFK



TRACON		x17.5	H (mm)	W (mm)	D (mm)
EDFK-..	EDFKN-..				
EDFK-4/1	EDFKN-4/1	4	200	110	70
EDFK-6/1	EDFKN-6/1	6	205	150	75
EDFK-8/1	EDFKN-8/1	8	205	190	75
EDFK-12/1	EDFKN-12/1	12	205	260	75
EDFK-12/2	EDFKN-12/2	24	330	270	75
EDFK-14/3	EDFKN-14/3	42	475	310	85
EDFK-18/1	EDFKN-18/1	18	220	365	75

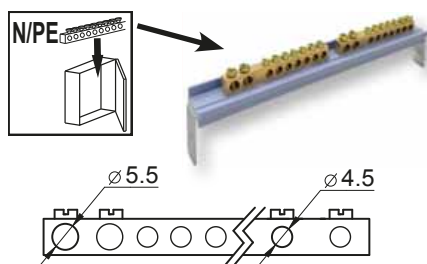

RELEVANT STANDARD
EN 62208

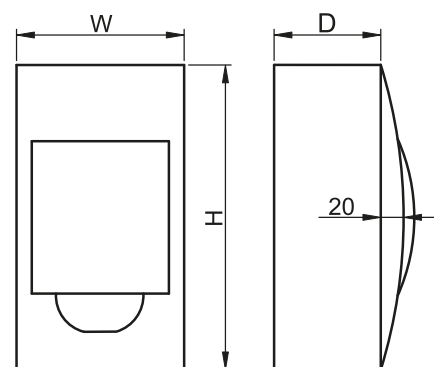

Rozdzielnice podtynkowe, seria EDS



TRACON		x17.5	H ₁ (mm)	W ₁ (mm)	D ₁ (mm)	H ₂ (mm)	W ₂ (mm)	D ₂ (mm)
EDS-..	EDSN-..							
EDS-4/1	EDSN-4/1	4	200	115	60	210	135	20
EDS-6/1	EDSN-6/1	6	200	160	60	210	170	20
EDS-8/1	EDSN-8/1	8	215	200	60	220	225	20
EDS-12/1	EDSN-12/1	12	200	260	60	220	280	20
EDS-12/2	EDSN-12/2	24	320	270	70	350	300	20
EDS-14/3	EDSN-14/3	42	475	310	75	500	340	20
EDS-18/1	EDSN-18/1	18	240	380	70	255	400	20

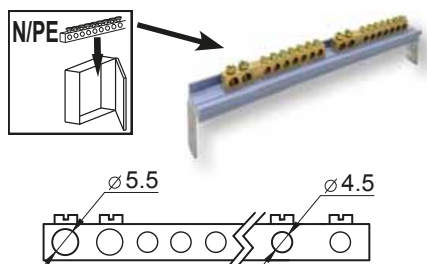

RELEVANT STANDARD
EN 62208

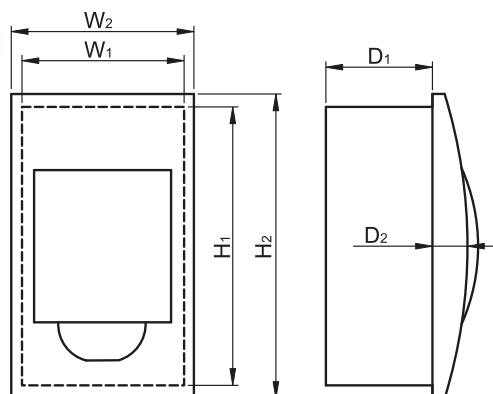

Natynkowe rozdzielnice z płaskimi drzwiami, seria EDFKS



TRACON		$\times 17.5$	H x W x D (mm)			
EDFKS-8/1	EDFKSN-8/1	1 x 8 (8)	195 x 240 x 90	-	-	-
EDFKS-12/1	EDFKSN-12/1	1 x 12 (12)	260 x 330 x 92	max. 2 x NPE-Z-24	-	-
EDFKS-12/2	EDFKSN-12/2	2 x 12 (24)	415 x 330 x 100	max. 2 x NPE-Z-24	max. 2 x ED-TLT12	max. 1 x ED-SEP12
EDFKS-12/3	EDFKSN-12/3	3 x 12 (36)	570 x 330 x 100	max. 2 x NPE-Z-24	max. 3 x ED-TLT12	max. 2 x ED-SEP12
EDFKS-18/2	EDFKSN-18/2	2 x 18 (36)	505 x 464 x 100	max. 2 x NPE-Z-38	max. 2 x ED-TLT18	max. 1 x ED-SEP18
EDFKS-18/3	EDFKSN-18/3	3 x 18 (54)	670 x 464 x 120	max. 2 x NPE-Z-38	max. 3 x ED-TLT18	max. 2 x ED-SEP18
EDFKS-18/4	EDFKSN-18/4	4 x 18 (72)	872 x 464 x 120	max. 4 x NPE-Z-38	max. 4 x ED-TLT18	max. 3 x ED-SEP18

Skrzynka rozdzielcza nie zawiera szyn N/PE!

- Drzwi otwierane pod kątem 180°
- Możliwość zmiany kierunku otwarcia drzwi
- Specjalny zamek z podwójną sprężyną
- Płyta plombowalna
- Obrotowa konsola wewnętrzna
- Ułatwienia tylne i boczne
- Przekładki izolacyjne - opcjonalnie
- Maskownice - opcjonalnie
- Szyny N/PE - opcjonalnie

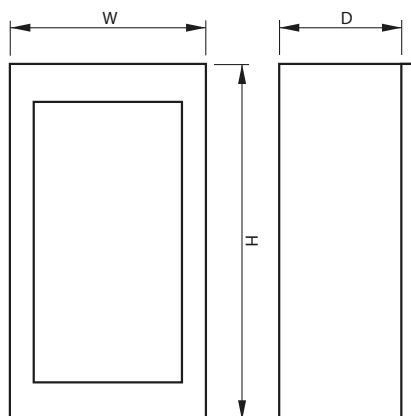

F/14-28



J/10-17

Podtynkowe rozdzielnice z płaskimi drzwiami, seria EDSS



TRACON			AKCESORIA				
			$H_1 \times W_1 \times D_1$ (mm)	$H_2 \times W_2 \times D_2$ (mm)			
EDSS-8/1	EDSSN-8/1	8	180 × 220 × 88	193 × 240 × 10	–	–	–
EDSS-12/1	EDSSN-12/1	12	240 × 305 × 80	262 × 330 × 10	max. 2 x NPE-Z-24	max. 1 x ED-TLT12	–
EDSS-12/2	EDSSN-12/2	24	395 × 305 × 85	420 × 330 × 17	max. 2 x NPE-Z-24	max. 2 x ED-TLT12	max. 1 x ED-SEP12
EDSS-12/3	EDSSN-12/3	36	545 × 305 × 85	570 × 330 × 17	max. 2 x NPE-Z-24	max. 3 x ED-TLT12	max. 2 x ED-SEP12
EDSS-18/1	EDSSN-18/1	18	270 × 440 × 85	300 × 465 × 17	max. 2 x NPE-Z-38	max. 1 x ED-TLT18	–
EDSS-18/2	EDSSN-18/2	36	480 × 440 × 90	505 × 465 × 17	max. 2 x NPE-Z-38	max. 2 x ED-TLT18	max. 1 x ED-SEP18
EDSS-18/3	EDSSN-18/3	54	655 × 440 × 90	685 × 465 × 20	max. 2 x NPE-Z-38	max. 3 x ED-TLT18	max. 2 x ED-SEP18
EDSS-18/4	EDSSN-18/4	72	860 × 440 × 95	880 × 465 × 20	max. 4 x NPE-Z-38	max. 4 x ED-TLT18	max. 3 x ED-SEP18

Rozdzielnice nie zawierają szyn N/PE!

- Drzwi otwierane pod kątem 180°
- Możliwość zmiany kierunku otwarcia drzwi
- Specjalny zamek z podwójną sprężyną
- Płyta plombowalna
- Obrotowa konsola wewnętrzna
- Ułatwienia tylne i boczne
- Przekładki izolacyjne - opcjonalnie
- Maskownice - opcjonalnie
- Szyny N/PE - opcjonalnie

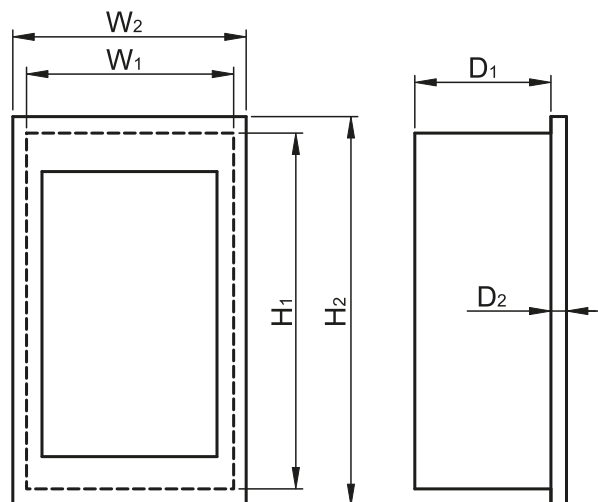

RELEVANT STANDARD
EN 62208



Akcesoria do rozdzielnic podtynkowych

Szyna izolowana uziemiająca (N/PE), zamknięta

230/400 V AC	I_n max. 100 A	U_i 500 V	Cu	IP 20	T_a -40..+85°C	V1 UL94
-----------------	------------------------	----------------	----	-----------------	---------------------	-------------------



TRACON	(mm)	\times x	I_n	mm ²	L (mm)	H (mm)	W (mm)	d (mm)	M
NPE-Z-24	6 × 9	24	max. 63 A	2,5-16 2,5-10	250	18,3	7,6	4 × 5,5 + 20 × 4,5	4 × M5 + 20 × M4
NPE-Z-38	8 × 12	38	max. 100 A	4-25 2,5-16	360	26,5	13,7	10 × 7,5 + 28 × 5,5	10 × M6 + 28 × M5

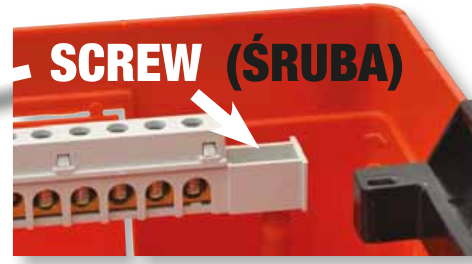
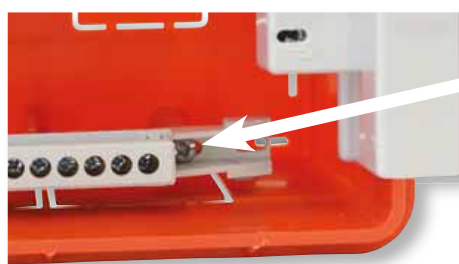
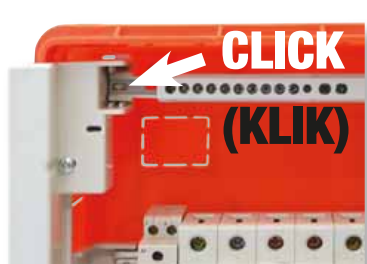
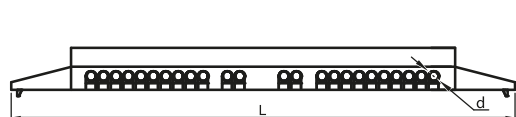

Pokrywa pełna do rozdzielnic

T_a -25..+55°C	HB UL94	ABS
---------------------	-------------------	-----



TRACON	\times 17.5
ED-TLT12	12 modul.
ED-TLT18	18 modul.



Ścianka działowa do rozdzielnic

T_a -25..+55°C	HB UL94	ABS
---------------------	-------------------	-----



TRACON	\times 17.5
ED-SEP12	12 modul.
ED-SEP18	18 modul.



Natynkowe rozdzielnice IP 65, seria EDFKIP65



TRACON	×17.5	H (mm)	W (mm)	D (mm)
EDFKIP65-4/1	4	210	140	100
EDFKIP65-8/1	8	210	215	100
EDFKIP65-12/1	12	260	300	140
EDFKIP65-18/1	18	285	410	140
EDFKIP65-12/2	24	415	300	140



RELEVANT STANDARD
EN 62208

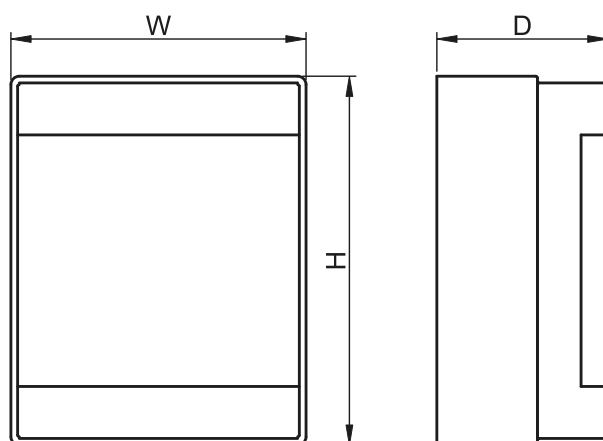

Skrzynki rozdzielcze bez drzwi

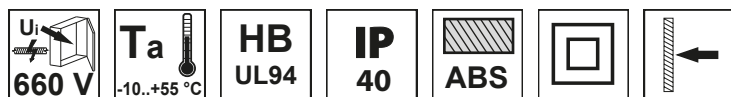

TRACON	×17.5	H (mm)	W (mm)	D (mm)	N/PE
EDFK-1/1AN	1	130	32	62	-
EDFK-2/1AN	2	130	52	62	-
EDFK-4/1AN	4	130	82	62	-
EDFK-8/1AN	8	160	160	62	✓
EDFK-12/1AN	12	160	260	65	✓
EDFK-18/1AN	18	160	365	60	✓

RELEVANT STANDARD
EN 62208

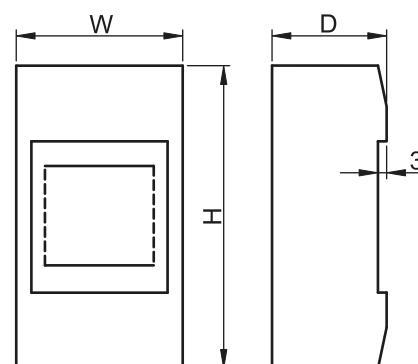

Skrzynki rozdzielcze bez drzwi, plombowane



TRACON	$\times 17.5$	H (mm)	W (mm)	D (mm)
EDFK-1/1ANP	1	140	35	60
EDFK-2/1ANP	2	140	50	60
EDFK-4/1ANP	4	140	90	60
EDFK-8/1ANP	8	160	180	60

RELEVANT STANDARD
EN 60670

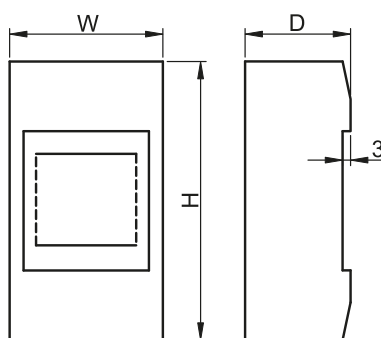

Obudowy urządzeń modułowych



TRACON	$\times 17.5$	35 \times 7.5	
TDT	1	✓	-
TDT-2	1	-	✓

Obudowa zabezpiecza urządzenie o rozmiarze jednego modułu. Możliwy montaż modułu na szynie montażowej. Obudowa umożliwia dostęp do elementów sterowniczych zabezpieczonego elementu.

Możliwe jest założenie blokady otwierania obudowy, co zabezpiecza przed dostępem do urządzenia.

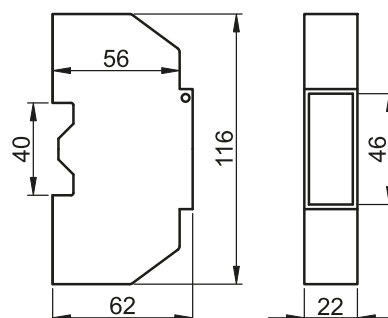

RELEVANT STANDARD
EN 60670



zamknięty spód



Plastikowa osłona pustych modułów w rozdzielnicy

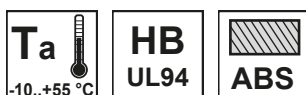

TRACON	$\times 17.5$
EDTM	$8 \times 1/2 + 2 \times 1 = 6$

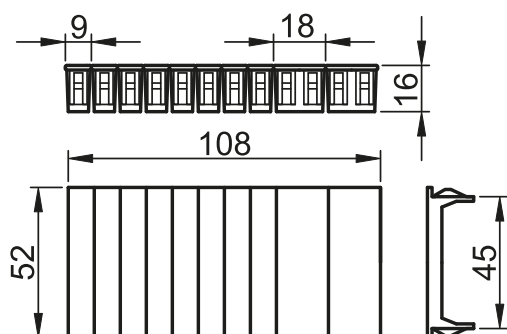

Umożliwia osłonięcie pustej przestrzeni obok zainstalowanych urządzeń, chroniąc przed zabrudzeniem i przypadkowym kontaktem. Wymagany rozmiar obudowy można łatwo wyłamać z dostarczanego kompletu osłony. Osłona składa się z ośmiu modułów o szerokości połowy modułu (9 mm) i 2 całych modułów (szerokość 18 mm).

Plastikowe rozdzielnice natynkowe z płytą montażową, z maskownicą lub bez, drzwiami przezroczystymi lub pełnymi



TRACON				H (mm)	W (mm)	D (mm)	×17,5mm Σs	X	N/PE
TME282113*	TME282113T*	TME282113M	TME282113MT	280	210	130	1 × 8	1	–
TME332513*	TME332513T*	TME332513M	TME332513MT	330	250	130	2 × 9	1	–
TME403017*	TME403017T*	TME403017M	TME403017MT	400	300	165	2 × 12	2	–
TME403020*	TME403020T*	–	–	400	300	195	–	2	–
TME504018*	TME504018T*	TME504018M	TME504018MT	500	400	175	3 × 17	2	–
TME604020*	TME604020T*	TME604020M	TME604020MT	600	400	200	4 × 17	2	–
TME605022*	TME605022T	TME605022M	TME605022MT	600	500	220	3 × 22	2	–
TME705025*	TME705025T*	TME705025M	TME705025MT	700	500	245	4 × 22	2	–

* z płytą montażową

Zamek plastikowy do rozdzielnic TME

TME-ZMH



Zamek bezpieczeństwa z kluczem do rozdzielnic TME

TME-ZM



- Zamek z korpusem plastikowym, wkładka i zasuwa metalowa, obrót 180° po montażu szafa posiada stopień ochrony IP 65
- Wykonanie klucza: uniwersalny

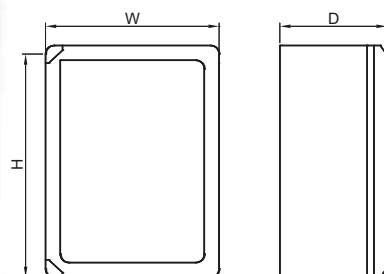

RELEVANT STANDARD
EN 62208

Dach przeciwdeszczowy do rozdzielnic TME

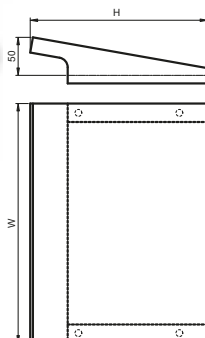

TRACON	W (mm)	H (mm)
TME403017R	300	170
TME504018R	400	175
TME604020R	400	200
TME705025R	500	245

Natynkowe rozdzielnice metalowe, seria EDFKF

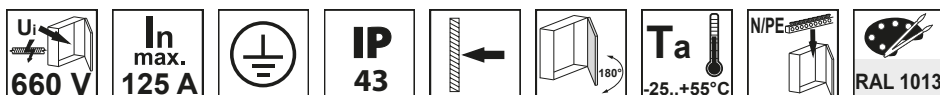

TRACON	×17,5mm Σs	×17,5	H (mm)	W (mm)	D (mm)
EDFKF-16/1	1 × 16	16	305	445	110
EDFKF-16/2	2 × 16	32	455	445	110
EDFKF-16/3	3 × 16	48	605	445	110
EDFKF-16/4	4 × 16	64	755	445	110

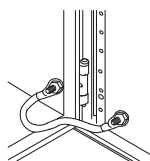
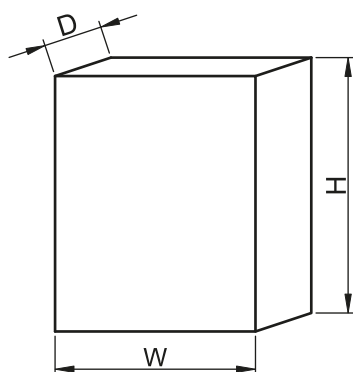

RELEVANT STANDARD
EN 62208

Podtynkowe rozdzielnice metalowe, seria EDSF

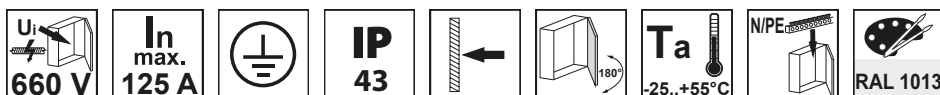

TRACON	×17,5mm Σs	×17,5	H (mm)	W (mm)	D (mm)
EDSF-16/1	1 × 16	16	326	464	115
EDSF-16/2	2 × 16	32	476	464	115
EDSF-16/3	3 × 16	48	626	464	115
EDSF-16/4	4 × 16	64	776	464	115

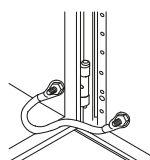
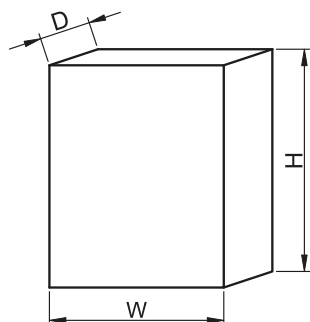

RELEVANT STANDARD
EN 62208



ZESKANUJ KOD!

- Odwiedź naszą stronę
- Bądź zawsze na bieżąco

Nasz asortyment jest na bieżąco rozwijany, niniejszy katalog odzwierciedla naszą ofertę w kwietniu 2021 roku. Aby być na bieżąco, śledź naszą stronę internetową!

Szafy metalowe maskowane, seria TFE

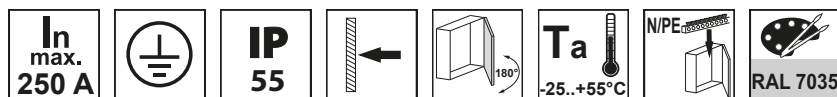

TRACON		×17,5mm Σs	×17.5 	H (mm)	W (mm)	D (mm)
TFE403020M	1	2 × 12	24	400	300	200
TFE504020M	2	3 × 16	48	500	400	200
TFE605020M	2	4 × 22	88	600	500	200
TFE806020M	2	5 × 27	135	800	600	200

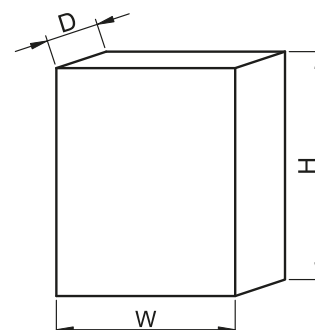
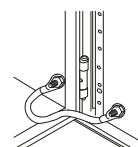

**RELEVANT STANDARD
EN 62208**

Dach przeciwdeszczowy do szaf maskowanych



TRACON	W (mm)	H (mm)
TFE403020T	300	200
TFE504020T	400	200
TFE605020T	500	200
TFE806020T	600	200

Do montażu zewnętrznego na dachu szaf maskowanych w celu zwiększenia ochrony przed czynnikami środowiskowymi.

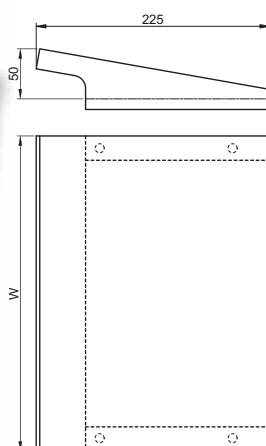

Metalowe skrzynki rozdzielcze, seria TFE

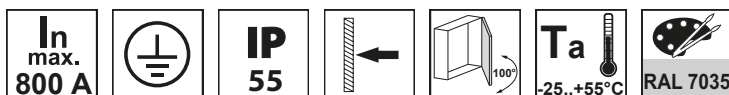

TRACON		H (mm)	W (mm)	D (mm)
TFE252015	1	250	200	150
TFE302515	1	300	250	150
TFE303015	1	300	300	150
TFE403015	1	400	300	150
TFE403020	1	400	300	200
TFE404020	1	400	400	200
TFE404025	1	400	400	250
TFE504015	1	500	400	150
TFE504020	1	500	400	200
TFE504025	1	500	400	250
TFE604020	2	600	400	200
TFE605015	2	600	500	150
TFE605020	2	600	500	200
TFE605025	2	600	500	250
TFE606025	2	600	600	250
TFE606030	2	600	600	300
TFE705020	2	700	500	200
TFE705025	2	700	500	250
TFE806020	2	800	600	200
TFE806025	2	800	600	250
TFE806030	2	800	600	300
TFE1006025	2	1000	600	250
TFE1008025	2	1000	800	250
TFE1008030	2	1000	800	300
TFE1008040	2	1000	800	400
TFE1208030	2	1200	800	300

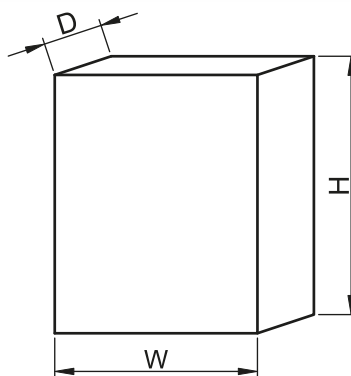

RELEVANT STANDARD
EN 62208

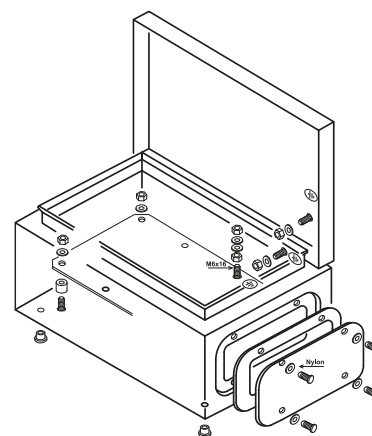

Metalowe skrzynki rozdzielcze TFE są dostępne w szerokiej gamie rozmiarów. Płyta montażowa umożliwia łatwy montaż urządzeń. Metalowa rama zapewnia stabilną konstrukcję. Skrzynki są dostarczane z drzwiami i z płytą montażową. Za pomocą ręczki można zamknąć drzwi. Standardowo klucz i zamek nie są częścią dostawy. Zmieniając pozycję montażową skrzynki można łatwo zmienić kierunek otwarcia drzwi. Inny sposób zmiany kierunku otwarcia drzwi to zmiana miejsca montażu zawiasów. W naszych skrzynkach rozdzielczych zalecamy instalację urządzeń na prądy znamionowe do 800 A. Drzwi są zamykane wkładką dwuzawiasową, wkładka jest zamawiana osobno.

Akcesoria



Drzwi dostępne z osłoną

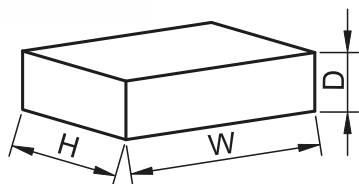
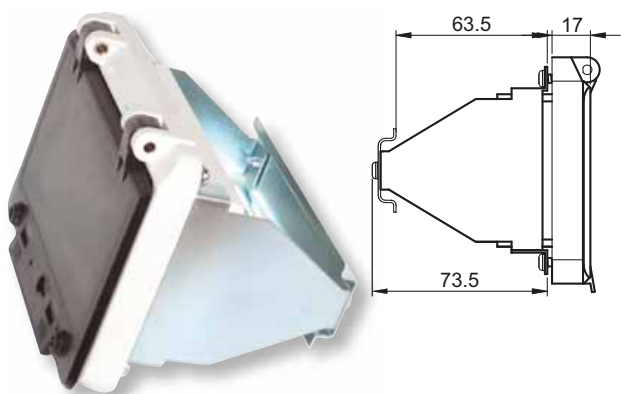

TRACON	×17.5	H × W × D (mm)	
TFE-KA8	8	162 × 98 × 95	65 × 148 mm
TFE-KA12	12	235 × 98 × 95	65 × 220 mm

Drzwi dostępne zapewniają bezpieczny dostęp do zainstalowanych urządzeń bez konieczności otwierania głównych drzwi obudowy. Drzwi dostępne zawierają adapter do montażu szyny za pomocą którego można zamontować urządzenia w żądanej odległości. Należy wyciąć obudowę w odpowiednim rozmiarze, następnie zamontować je za pomocą śrub. W celu uszczelnienia drzwi należy zastosować śruby z otworami w główkach.

W celu zapewnienia stopnia ochrony IP 44 należy założyć blokową osłonę uchylną, a między drzwiami i powierzchnią obudowy należy umieścić uszczelnienie. Plastikowa osłona, w której znajdują się wycięcia o szerokości równej połowie wielkości standardowego modułu, zapewnia ochronę przed przypadkowym dotykiem.

Ścianki wentylacyjne

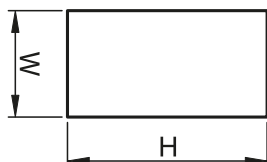

TRACON	W (mm)	H (mm)	
TFE-SZ1	150	200	115 × 160 mm
TFE-SZ2	140	140	100 × 100 mm
TFE-SZ3	115	200	50 × 160 mm



Gdy temperatura lub wilgotność przekraczają dopuszczalne wartości dla zainstalowanych urządzeń, należy zapewnić im właściwą wentylację. Zmieniając rozmiar ścianki wentylacyjnej można regulować stopień wentylacji. W razie potrzeby można założyć więcej ścianek wentylacyjnych. Po wycięciu otworu o odpowiedniej wielkości należy założyć dołączone uszczelnienie i zamontować ściankę za pomocą śrub. Ochrona obudowy: IP43, kolor: malowany proszkowo RAL 7035.

LED

ŹRÓDŁA ŚWIATŁA

E/86-105

Plastikowy zamek do rozdzielnic metalowych

TRACON		
TFE-ZM2	5 mm	22,5 mm
TFE-ZT	5 mm	22,5 mm

- Zamek z korpusem plastikowym, wkładka i zasuwa metalowa, obrót 90° po montażu szafa posiada stopień ochrony IP55
- Wykonanie klucza: uniwersalny (uchwyt plastik, klucz metal)

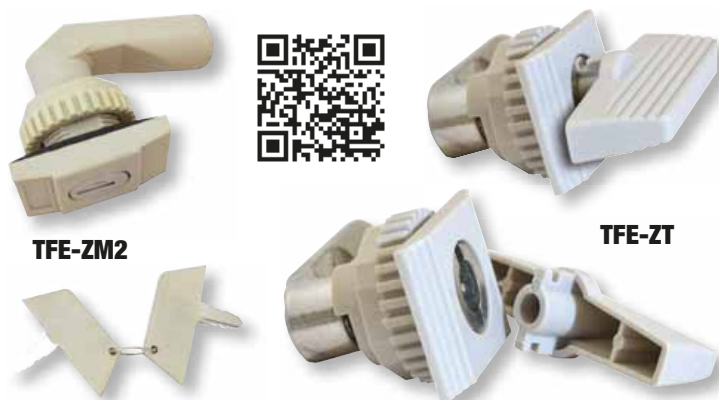

Uchwyt do projektów

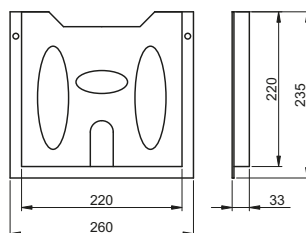

TRACON	
TFE-A4	A4

Zgodnie z obowiązującymi przepisami należy zapewnić miejsce do przechowania schematów w rozdzielnicach. Uchwyt umożliwia przechowywanie dokumentów o rozmiarze A4. Na tylnej ściance posiada paski samoprzylepne, jednak można również montować go za pomocą śrub.

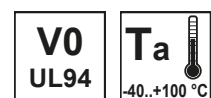

Przepusty kablowe do rozdzielnic



TRACON	 \varnothing mm													A × B (mm)	
	3-7	3,5-11	5-10	7-12	7-13	9-16	10-14	10-30	14-18	14-22	14-35	15-25			24-54
EKBV-01	-	-	-	-	-	-	-	-	-	× 4	-	-	-	× 4	138 × 48
EKBV-02	-	-	-	× 2	-	-	-	× 8	-	-	-	-	-	× 10	216 × 84
EKBV-03	-	-	-	-	-	-	× 5	-	× 4	× 3	-	-	× 2	× 14	222 × 92
EKBV-04	-	× 2	-	× 5	-	-	-	-	× 12	× 5	× 1	-	-	× 25	222 × 92
EKBV-05	-	-	-	-	× 50	-	-	-	-	-	-	× 1	-	× 51	222 × 92
EKBV-10	× 5	-	× 4	-	× 2	× 1	-	-	-	-	-	-	-	× 12	107 × 56
EKBV-16	× 12	-	-	-	× 5	-	-	-	-	-	-	-	-	× 17	127 × 56
EKBV-24	× 6	-	× 6	-	-	× 5	-	-	-	-	-	-	-	× 17	153 × 56

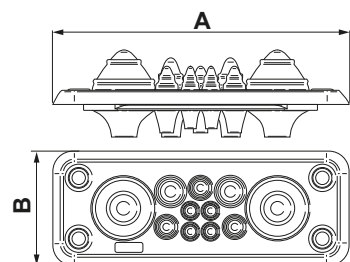

Metalowe rozdzielnice ze szklanymi, zaokrąglonymi drzwiami, seria TGE

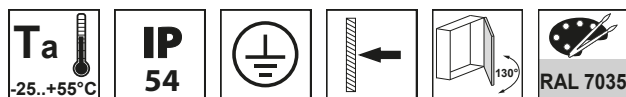

TRACON	×17,5mm Σs	×17,5	L (mm)	W (mm)	H (mm)
TGE606020	3 × 24	72	600	600	200
TGE607520	4 × 24	96	750	600	200
TGE609020	5 × 24	120	900	600	200
TGE6010520	6 × 24	144	1050	600	200
TGE6012025	7 × 24	168	1200	600	250
TGE6015025	9 × 24	216	1500	600	250
TGE6018025	11 × 24	264	1800	600	250

Skrzynka rozdzielcza nie zawiera szyn N/PE!

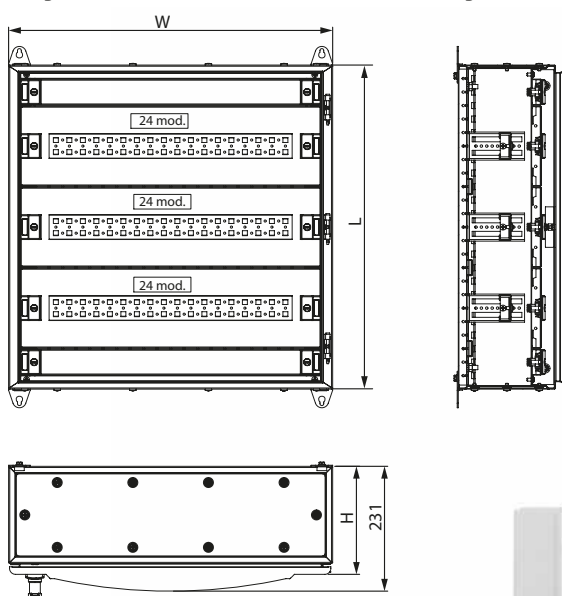

RELEVANT STANDARD
EN 572-1

RELEVANT STANDARD
EN 60670-24
EN 13501

Rozdzielnice metalowe, drzwi metalowe, seria TGEF



TRACON	×17,5mm Σs	×17,5	L (mm)	W (mm)	H (mm)
TGEF606020	3 × 24	72	600	600	200
TGEF607520	4 × 24	96	750	600	200
TGEF609020	5 × 24	120	900	600	200
TGEF6010520	6 × 24	144	1050	600	200
TGEF6012025	7 × 24	168	1200	600	250
TGEF6015025	9 × 24	216	1500	600	250
TGEF6018025	11 × 24	264	1800	600	250

Skrzynka rozdzielcza nie zawiera szyn N/PE!

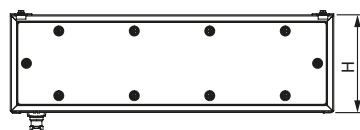
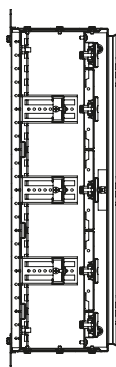
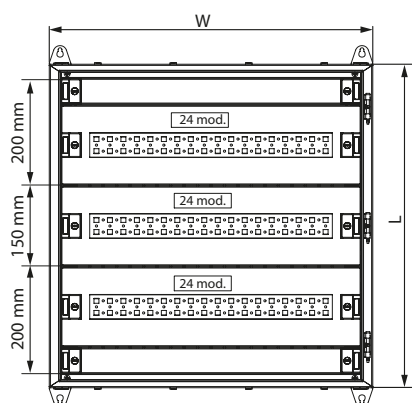

TGEF606020



TGEF6010520



TGEF6018020



ZESKANUJ KOD!

- Odwiedź naszą stronę
- Bądź zawsze na bieżąco

Nasz asortyment jest na bieżąco rozwijany, niniejszy katalog odzwierciedla naszą ofertę w kwietniu 2021 roku. Aby być na bieżąco, śledź naszą stronę internetową!

AKM

WYŁĄCZNIK KOMPAKTOWY

TRACON
.....**ELECTRIC**®



I/2-5

Akcesoria

1. Płyty montażowe, pokrywy

TRACON	W (mm)	H (mm)	D (mm)
TGEBM150	495	150	13
TGEBM200	495	200	13
TGEMP150	450	150	20
TGEMP200	450	200	20

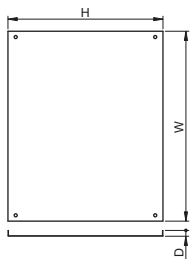

TGEBM...



TGEMP...

Wysokość modułu dolnego i górnego wynosi 200 mm, a modułów pośrednich 150 mm.

2. Ramka do instalacji podłogowej

TRACON	W (mm)	H (mm)	D (mm)
TGEBF	600	180	50
TGEBF25	600	230	50

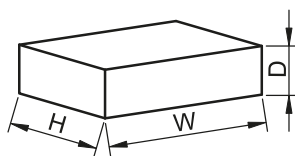

4. Grzebieniowy wpust kablowy

TRACON	W (mm)	H (mm)	D (mm)
TGECE	568	152	6

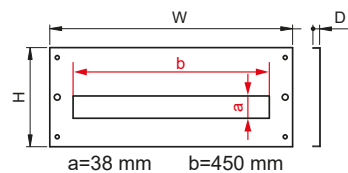

5. Szyna izolowana uziemiająca N/PE

TRACON	(mm)	X	In	mm ²	L (mm)	H (mm)	W (mm)	d (mm)	M	
NPE-Z-24	6 × 9	24	max. 63 A	2,5-16	2,5-10	250	18,3	7,6	4 × 5,5 + 20 × 4,5	4 × M5 + 20 × M4
NPE-Z-38	8 × 12	38	max. 100 A	4-25	2,5-16	360	26,5	13,7	10 × 7,5 + 28 × 5,5	10 × M6 + 28 × M5

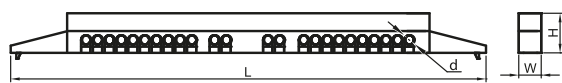

NPE-Z-38



NPE-Z-24

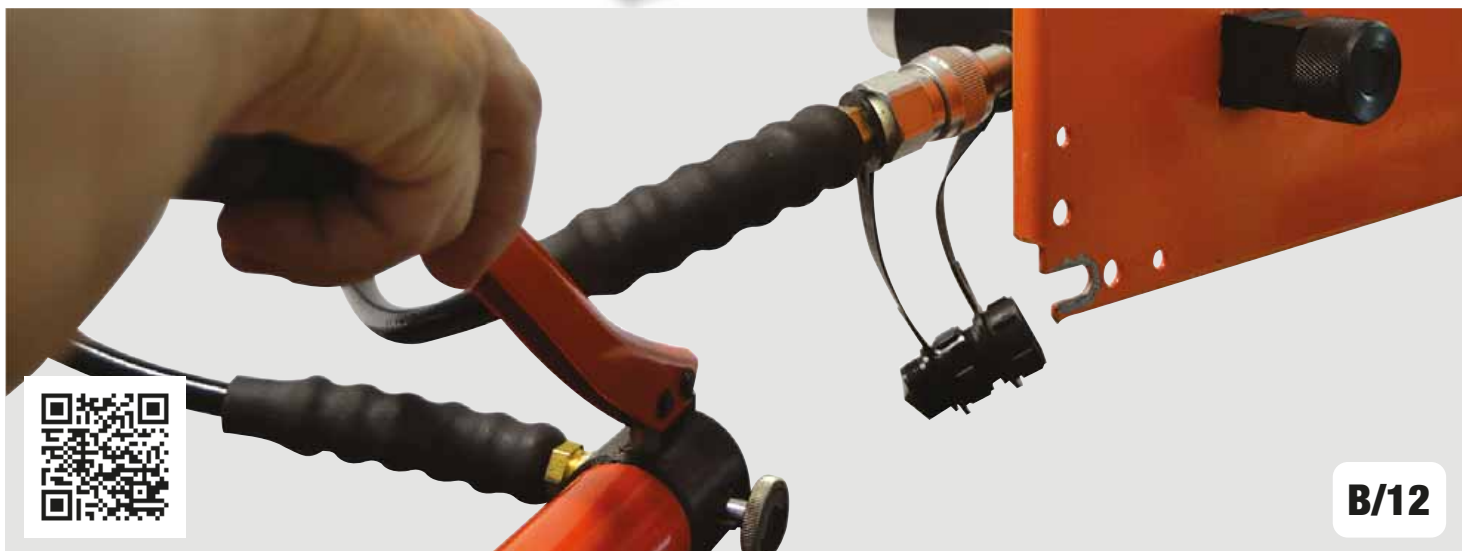

B/12

Wentylatory z filtrem



TRACON	m³/h	I_n	P_{max}			A (mm)		D (mm)	E (mm)	
V35	35* m³/h	0,07 A	12 W	31 dB (A)	V35-KNY	105	92	5	50	5
V43	43* m³/h	0,11 A	19 W	46 dB (A)	V43-KNY	150	124	5	61	5
V71	71* m³/h	0,11 A	19 W	46 dB (A)	V71-KNY	250	224	6	100	5
V150	150* m³/h	0,14 A	21 W	42 dB (A)	V150-KNY	150	125	5	50	5
V170	170* m³/h	0,28 A	41 W	54 dB (A)	V170-KNY	250	224	6	134	5
V215	215* m³/h	0,22 A	33 W	50 dB (A)	V215-KNY	250	221	7	115	5
V360	360* m³/h	0,34 A	64 W	54 dB (A)	V360-KNY	325	291	6	150	5
V375	375* m³/h	0,25 A	55 W	60 dB (A)	V375-KNY	325	291	7	150	5

* bez filtra, w przypadku stosowania na wylocie rozdzielnic



V43



V71, V170



V360

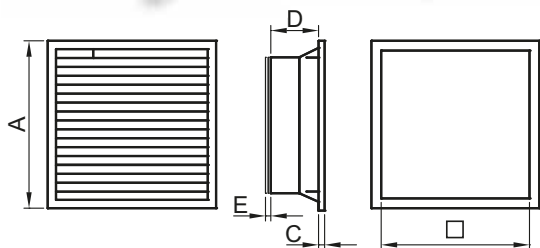

V35



V150



V215



V43-KNY

**V71-KNY
V170-KNY**

V360-KNY

TRACON	A (mm)		D (mm)	E (mm)	
V35-KNY	105	92	5	25	-
V43-KNY	150	124	5	23	-
V71-KNY	250	224	6	25	-
V150-KNY	150	125	5	25	-
V170-KNY	250	224	6	25	-
V215-KNY	250	221	7	25	-
V360-KNY	325	291	6	26	-
V375-KNY	325	291	7	30	-

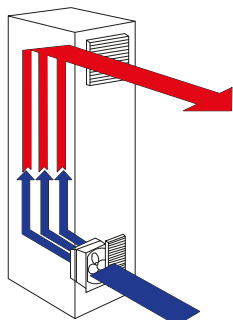

Nowa rodzina wentylatorów jest stosowana głównie w przemyśle, w serwerowniach oraz w takich miejscach, gdzie zamontowane urządzenia wymagają regularnej wymiany powietrza. Montaż odbywa się w prosty i szybki sposób poprzez zatrzaski, bez zastosowania śrub.

Wentylatory i otwory wyjściowe są fabrycznie wyposażone w bardzo cienki wkład filtrujący, który zapobiega dostawaniu się kropeł deszczu i drobin kurzu większych niż 1 mikron, w ten sposób zachowana jest ochrona IP54. Wentylator można obrócić w celu ustawienia kierunku przepływu powietrza. Należy je montować mniej więcej na 1/3 wysokości i zawsze stosować wraz z otworem wyjściowym (filtrem). System można wyposażyć w termostat regulujący automatyczne wentrowanie.

Grzejniki kompaktowe do rozdzielnic

120-250 V AC/DC	IP 20	T_a -45...+70°C	[mm ²] 0,5-2,5		 35x7.5
--------------------	-----------------	-------------------------------------	-------------------------------	--	------------

TRACON	 P _{th}	H (mm)	
FE15	15 W	65	300 g
FE30	30 W	65	300 g
FE45	45 W	65	300 g
FE60	60 W	140	400 g
FE75	75 W	140	500 g
FE100	100 W	140	500 g
FE150	150 W	220	700 g

W celu przeciwdziałania kondensacji wilgoci warto zastosować w szafach grzejniki kompaktowe. Jest to szczególnie istotne zimą, jeśli instalacja jest zewnętrzna i gdy elektronika sterująca jest wrażliwa. Grzejniki są dostępne w zakresie mocy 15-150W.

Montaż jest prosty, ponieważ grzejniki są dostosowane do instalacji na standardowych szynach montażowych. Element grzewczy powinien być zawsze montowany w układzie pionowym! W większych szafach zalecane jest stosowanie większej ilości grzejników aby osiągnąć równe rozproszenie temperatury.

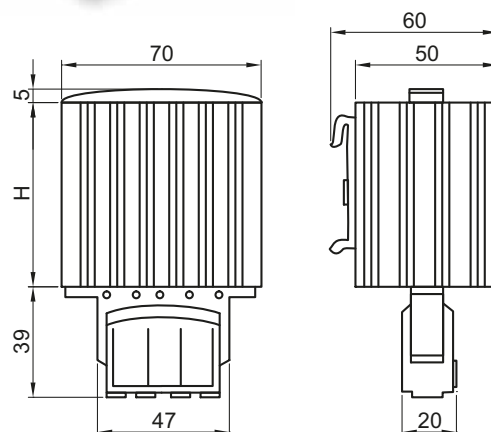

Grzejniki kompaktowe do rozdzielnic z wentylatorem

230 V AC	IP 20	T_a -45...+70°C	[mm ²] 1,5-2,5		 35x7.5
-------------	-----------------	-------------------------------------	-------------------------------	--	------------

TRACON	 P _{th}	 m ³ /h	 T _h	H (mm)	
FEV250	250 W	45 m ³ /h	max. 75 °C	182	1.100 g
FEV400	400 W	45 m ³ /h	max. 75 °C	222	1.400 g

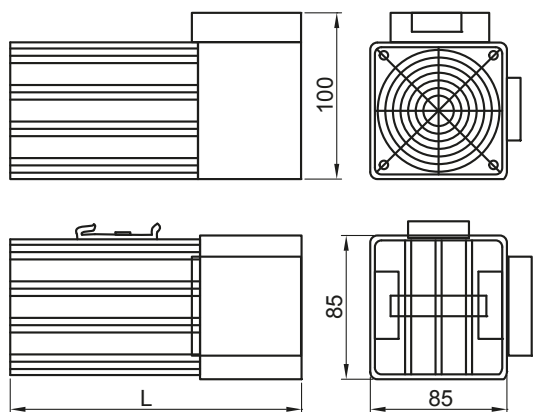

Wersje grzejników kompaktowych wraz z wentylatorami pozwalają uzyskać bardziej efektywne ogrzewanie i rozproszenie ciepła. Funkcjonalność i wykonanie są bardzo podobne do standardowych grzejników. Urządzenia są zabezpieczone przed przegrzewaniem się.

Termostat (Regulator temperaturey)

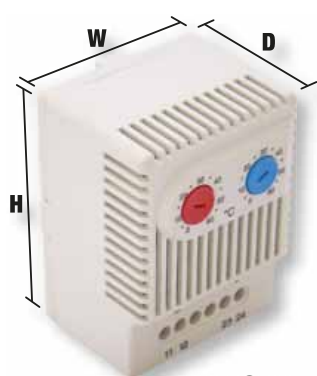

THMS-11

230 V AC	TRACON		VDC VAC A		H × W × D (mm)
-----------------	---------------	--	------------------	--	-----------------------

IP 20	THMS-01 ●		10 A	1 × NC	–	60 × 43 × 33
	THMS-10 ●	0-60 °C	250 V AC /	–	1 × NO	60 × 43 × 33
	THMS-11 ●		24 V DC	1 × NC	1 × NO	67 × 50 × 46

Ta
-20..+80°C

[mm²]
1,5-2,5

35×7.5

**RELEVANT STANDARD
EN 60730-2-9**

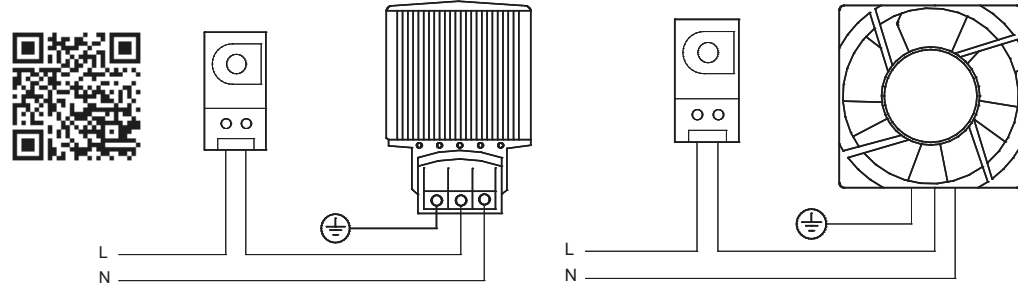

Higrostat



230 V AC	TRACON		VDC VAC A		H × W × D (mm)
-----------------	---------------	--	------------------	--	-----------------------

IP 20	HGS-01	35-90 %	5 A 250 V AC	1 × CO		67 × 50 × 38
--------------	---------------	---------	--------------	--------	--	--------------

Ta
-20..+80°C

[mm²]
1,5-2,5

35×7.5

**RELEVANT STANDARD
EN 60730-2-13**

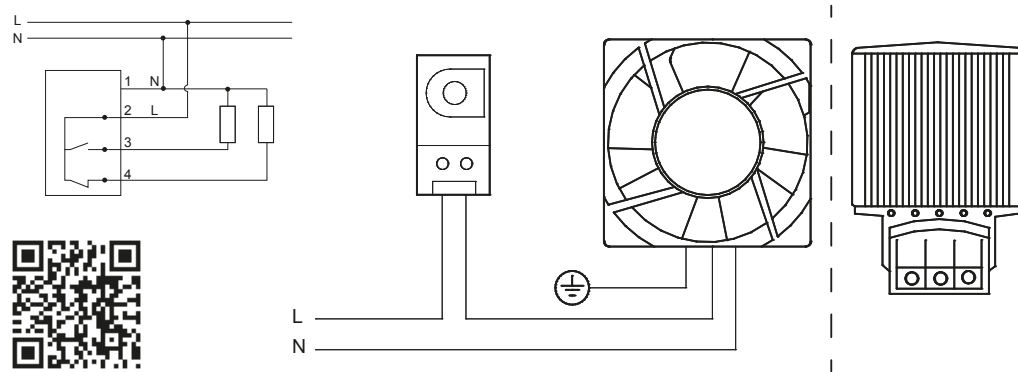

Odgaźniki do szyn prądowych

230/400 V AC Cu

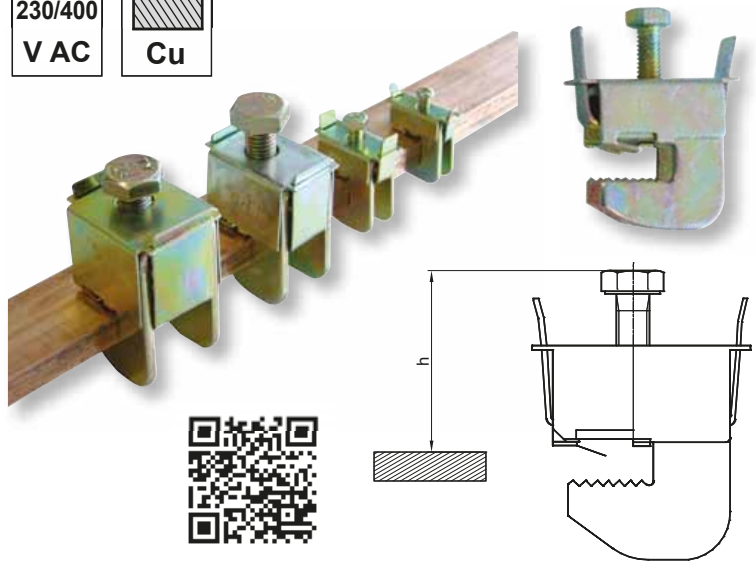

Spis piktogramów H/O

TRACON	mm ²	d	h_{min} (mm)	h_{max} (mm)
GLK1-0104	1-4	4-5 mm	17	23
GLK1-2516	2.5-16	4-5 mm	22	29
GLK1-1650	16-50	4-5 mm	26	39
GLK1-3570	35-70	4-5 mm	39	57
GLK2-0104	1-4	9-10 mm	17	23
GLK2-2516	2.5-16	9-10 mm	22	29
GLK2-1650	16-50	9-10 mm	26	39
GLK2-3570	35-70	9-10 mm	39	57
GLK2-70185	70-185	9-10 mm	44	66

Regulowane uchwyty do kabli

TRACON		B (mm)	H (mm)
AKR1-0612	6-12 mm	31	70
AKR1-1218	12-18 mm	24	70
AKR1-1822	18-22 mm	28	70
AKR1-2230	22-30 mm	39	85
AKR1-3038	30-38 mm	45	90
AKR1-3842	38-42 mm	47	95
AKR1-4250	42-50 mm	57	120
AKR1-5064	50-64 mm	70	130

Gdy wprowadza się kable do rozdzielni, często istnieje potrzeba umocowania przewodu, do tego służą poniższe uchwyty. Uchwyt w kształcie haka należy zamocować na wcześniej przytwierdzonej szynie, a następnie zacisnąć wraz z kablem.

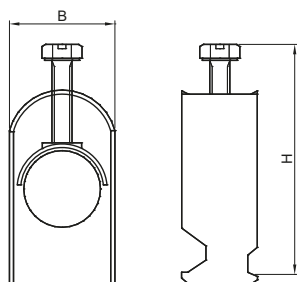



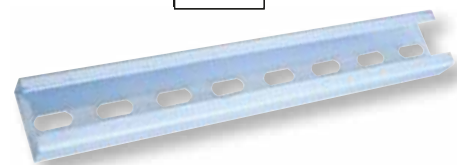
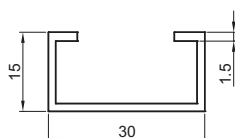

Szyna do zamocowania uchwyty do kabli

TRACON	
30/15SIN	1 m



Izolatory wsporcze

TRACON	H (mm)	M (mm)	D (mm)	B (mm)	A (mm)	 (N)	 (N)		
STS-25	25	6	24	26,5	9	3000	2000	3	28 g
STS-30-6	30	6	27	32,4	10	4600	3500	3	44 g
STS-30	30	8	27	32,4	10	4600	3500	6	44 g
STS-35-6	35	6	28	31,9	8	5500	4300	3	50 g
STS-35	35	8	28	31,9	8	5500	4300	6	50 g
STS-40-6	40	6	34	40,1	10	6200	5000	3	86 g
STS-40	40	8	34	40,1	10	6200	5000	6	86 g
STS-40-10	40	10	34	40,1	10	6200	5000	10	86 g
STS-51	51	8	29	35,3	13	6400	5250	6	83 g
STS-51-10	51	10	29	35,3	13	6400	5250	10	83 g
STS-51-12	51	12	29	35,3	13	6400	5250	14	83 g
STS-76	76	10	35	49,8	16	7000	5900	10	233 g

1.000 V AC	1.500 V DC	Utest 1min 5 kV
---------------	---------------	-----------------------

VO UL94	Ta -40..+130 °C
------------	--------------------



Izolatory wsporcze mogą być stosowane do instalacji różnego rodzaju bezpieczników, szyn, elektrycznych skrzynek rozdzielczych i połączeniowych i innych urządzeń pracujących przy napięciu w zakresie wartości znamionowych izolatorów. Są lżejsze niż izolatory porcelanowe i wymagają mniej miejsca. Izolatory wsporcze są wykonane z mieszanki żywicznej i mączki kwarcowej. W procesie wtrysku metalowe wkładki gwintowane są mocowane wewnątrz plastikowej obudowy. Izolatory wsporcze mają dobre właściwości mechaniczne, temperaturowe i charakteryzują się wysokimi parametrami elektrycznymi. Ich montaż jest szybki i precyzyjny. W przypadku, gdy wymagana jest większa wytrzymałość dielektryczna, możliwe jest zastosowanie kilku izolatorów wsporczych.

RELEVANT STANDARD
EN 60660

