



Orodje za stiskanje votlic **2**



Orodje za rezanje in odstranjevanje izolacije **3**



Univerzalne klešče za odstranjevanje izolacije in rezanje **4**



Klešče za rezanje, odstranjevanje izolacije ter stiskanje telefonskih priključkov **4**



Univerzalne klešče za stiskanje neizoliranih in izoliranih enojnih in dvojnih votlic **5**



Klešče za stiskanje izoliranih kabelskih čevljev **6**



Univerzalne klešče za stiskanje neizoliranih kabelskih čevljev **6**



Klešče za stiskanje neizoliranih kabelskih čevljev s kalupom **7**



Univerzalne klešče za stiskanje neizoliranih kabelskih spojk **7**



Ročne hidravlične klešče za stiskanje **8**



Hidravlične klešče za stiskanje z akumulatorjem **9**



Polnilec akumulatorjev **9**



Akumulator **9**



Akumulatorske hidravlične klešče za stiskanje, s kalupi, v kovčku **10**



Akumulatorske hidravlične škarje za rezanje, v kovčku **11**



Hidravlična štanca in stiskalnica **12**



Klešče s prestavnim razmerjem za rezanje Cu, Al vodov **13**



Klešče za rezanje Cu, Al vodov **14**



Klešče - izolirane (1000 V) **14**

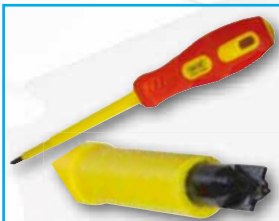

Izvijač, križni-kombi, izolirano na 1000V **15**

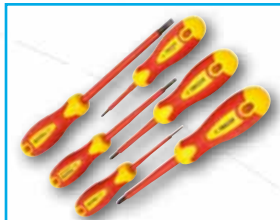

Set izvijačev, izoliran na 1000V **15**



Izvijači SD - CrV **16**



Izvijači SD - CrV **17**



Klešče za napanjanje in rezanje vezic **18**



Klešče za napanjanje in rezanje jeklenih vezic **18**



Vrvi za napeljanje vodov **18**



Toplozračne pištole **19**



Nož za odstranjevanje izolacije **19**



Orodje za lupljenje kablov **19**



UTILK Tapetniški noži **20**



BD Rezila **21**

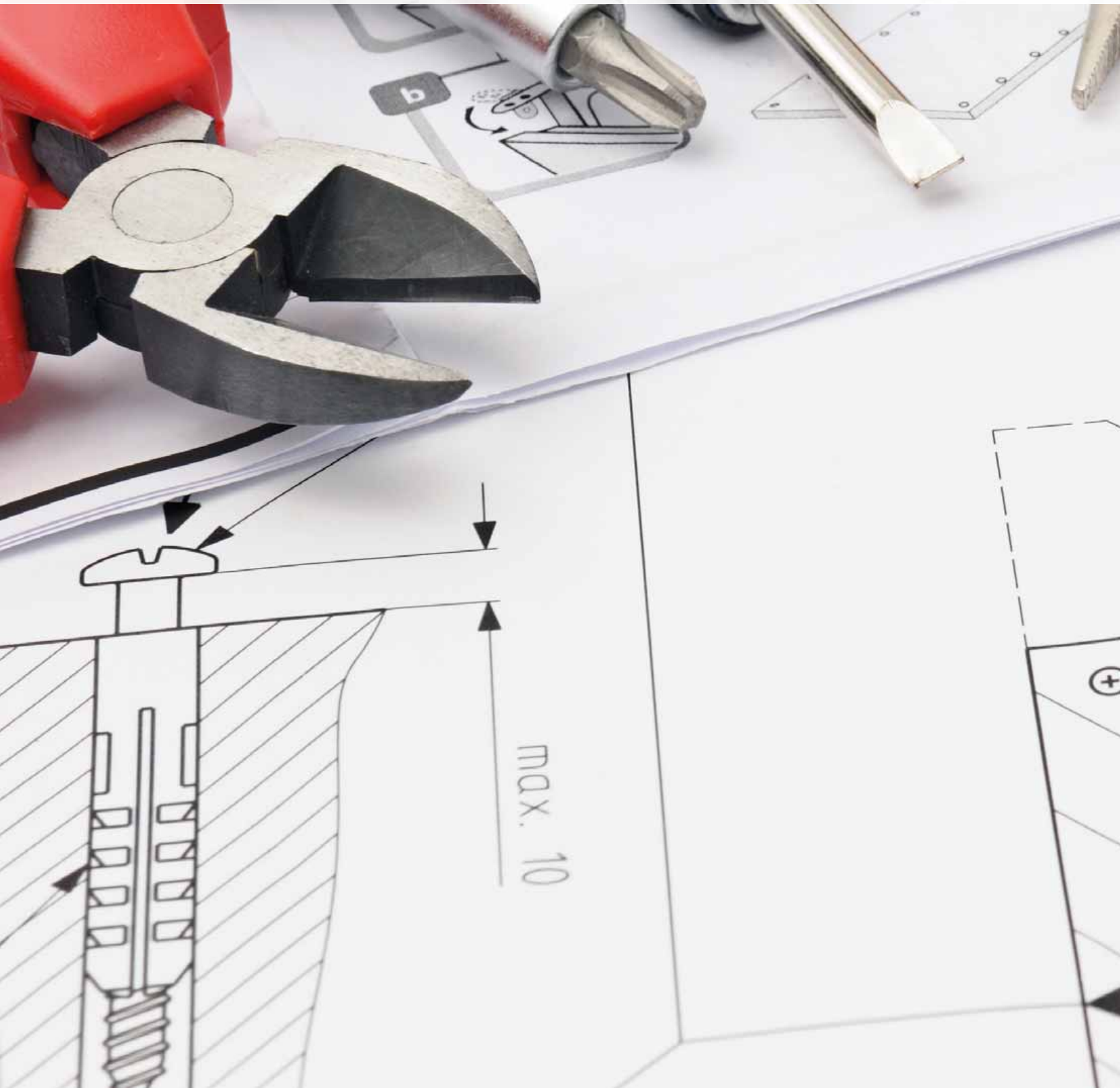

## Razlaga piktogramov v glavi tabel

 Masa	 Temperatura okolja	 Tip izvijača	 Dolžina orodja
 Največji presek rezanja	 Največji premer rezanja	 Območje stiskanja	 mm <sup>2</sup> Presek priključnega vodnika
 Dolžina hoda bata	 Kapaciteta štancanja	 Največja sila stiskanja	 Glava je vrtljiva za 360°
 Kapaciteta akumulatorja (Ah)	 Napetost akumulatorja (V)	 Tip akumulatorja	 Vpenjalna sila je nastavljiva
 Širina rezanja	 Opombe, dopolnitve	 Nazivna napetost (V)	 Nazivna moč





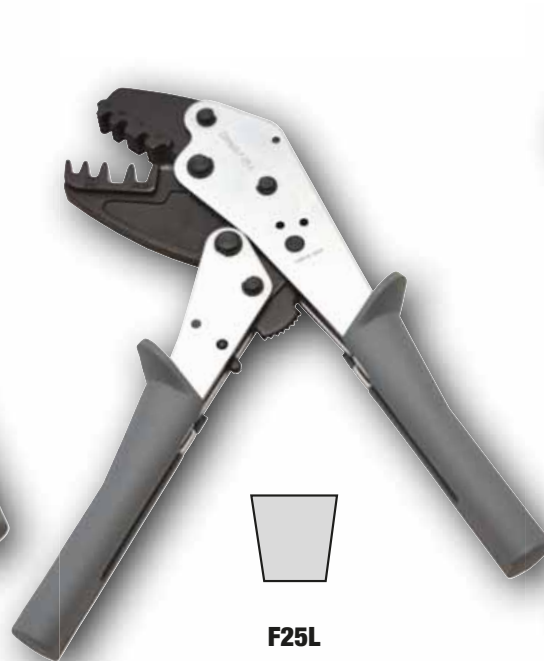

**Orodje za stiskanje votlic**

TRACON	 mm <sup>2</sup>		
F6L	0,5-6	205 mm	470 g
F25L	6-25	240 mm	620 g
F50L	35-50	240 mm	620 g



## Orodje za rezanje in odstranjevanje izolacije

TRACON	 mm <sup>2</sup>		 m
MACS6	0,08-6	205 mm	180 g
MACS16	6-16	205 mm	180 g



## Klešče za stiskanje priključkov SOLAR11-4AB in SOLAR11-4N

TRACON	 mm <sup>2</sup>		 m
SOLAR11-PT	2.5-6	270 mm	725 g / 1710 g





**PROSIMO, ODČITAJTE KODO!**

- Oglejte si novosti
- Bodite na tekočem

Naša paleta izdelkov se nenehno širi!  
 Katalog odraža stanje aprila 2021.  
 Za ažurne informacije obiščite  
 našo spletno stran!





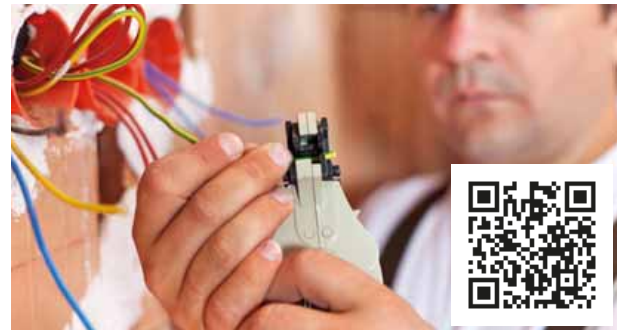

**Univerzalne klešče za odstranjevanje izolacije in rezanje za energetske kable**

TRACON	 mm²		
<b>TKCS</b>	0,1-4 (6)	200 mm	175 g
<b>TP700A</b>	0,25-2,5	180 mm	380 g
<b>TP700B</b>	0,75-6	180 mm	380 g
<b>LY731</b>	0,5-6	200 mm	300 g

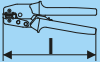

**Klešče za rezanje, odstranjevanje izolacije ter stiskanje komunikacijskih priključkov**

TRACON			
<b>RJ86</b>	220 mm	310 g	RJ11, RJ12, RJ45
<b>RJ468</b>	220 mm	200 g	RJ11, RJ12, RJ45, RJ50
<b>RG317</b> 	230 mm	200 g	BNC, TNC, RG 1,72 / 2,6 / 5,4 / 6,5 / 8,1 mm











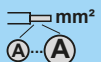
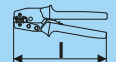



**PROSIMO, ODČITAJTE KODO!**

- Oglejte si novosti
- Bodite na tekočem

**Naša paleta izdelkov se nenehno širi!  
 Katalog odraža stanje aprila 2021.  
 Za ažurne informacije obiščite  
 našo spletno stran!**

**Univerzalne klešče za stiskanje neizoliranih in izoliranih enojnih in dvojnih votlic**

TRACON		 mm <sup>2</sup>		
<b>9039</b>		6-16	230 mm	600 g
<b>9102-LT</b>		0,25-2,5	145 mm	160 g
<b>9004-LT</b>		0,5-16	180 mm	320 g
<b>9039A-SPEC</b>		0,25-6	175 mm	400 g
<b>9039B-SPEC</b>		6-16	210 mm	470 g
<b>9039-HEXA</b>		0,25-6	175 mm	400 g
<b>9039A</b>		1,5-6	230 mm	600 g
<b>9039AR</b>		0,5-6	230 mm	600 g
<b>9039BR</b>		10-35	230 mm	600 g
<b>9039B</b>		10-35	230 mm	600 g

 **Razlaga piktogramov** **B/O**



**9039A-SPEC**  
**9039B-SPEC**



**9039AR**  
**9039BR**



**9039**  
**9039B**



**9102-LT**  
**9004-LT**









**9039-HEXA**



**9039A**











## Univerzalne klešče za stiskanje izoliranih kabljskih čevljev

TRACON		 mm <sup>2</sup>		 m
<b>LY35C</b>		10-35	490 mm	2.150 g
<b>9006RS</b>		0,5-2,5	230 mm	600 g
<b>9006R</b>		2,5-6	230 mm	600 g
<b>9006</b>		2,5-6	230 mm	600 g











## Univerzalne klešče za stiskanje neizoliranih kabljskih čevljev

TRACON		 mm <sup>2</sup>		 m
<b>HD156R</b>		1,5-6	225 mm	540 g
<b>HD156</b>		1,5-6	247 mm	540 g
<b>KH8</b>		1,5-10	280 mm	470 g
<b>KH14</b>		6-16	280 mm	470 g
<b>KH16</b>		1,5-16	280 mm	470 g



## Klešče za stiskanje neizoliranih kabelskih čevljev - dobava s kalupom vred

TRACON					mm <sup>2</sup>		m
<b>KH120</b>					10-95	645 mm	3.000 g
<b>HX50B*</b>					6-50	390 mm	1.300 g
<b>HX120B*</b>					10-120	630 mm	4.000 g
<b>HX150B*</b>					25-150	650 mm	3.200 g

\* Območje stiskanja je odvisno od kabelskega čevlja, ki ga uporabljamo, ali od tipa in dimenzij veznega tulca. Glej poglavje A.

\*\* V primeru obrabe priloženih kalupov je dodatne kalupe možno naročiti posebej kot dodatno opremo! Glej šifre spodaj!



**KH120**



**HX50B  
HX120B  
HX150B**

**HX50B-FEJ\*\***  
Kalup za stiskanje neizoliranih kabelskih čevljev iz bakra in aluminija se lahko naroči tudi posebej.







**HX120B-FEJ\*\***  
Kalup za stiskanje neizoliranih kabelskih čevljev iz bakra in aluminija se lahko naroči tudi posebej.



**HX150B-FEJ\*\***  
Kalup za stiskanje neizoliranih kabelskih čevljev iz bakra in aluminija se lahko naroči tudi posebej.

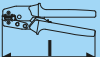

## Univerzalne klešče za stiskanje neizoliranih kabelskih kontaktov

TRACON			mm <sup>2</sup>		m
<b>LY03BR</b>			0,5-6	230 mm	600 g
<b>LY03B</b>			0,5-6	230 mm	600 g

 **Razlaga piktogramov B/O**











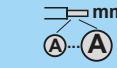

**LY03BR**



**LY03B**



**Ročne hidravlične klešče za stiskanje - dobava brez kalupa**



TRACON		 mm <sup>2</sup>	 kN <sub>max</sub>			 m
<b>D31*</b>		4-95	35	360°	200 mm	1.550 g
<b>D51*</b>		10-185	55	180°	365 mm	2.500 g
<b>D52F*</b>		10-240	67	180°	375 mm	2.800 g
<b>C120F*</b>		16-400	120	180°	590 mm	7.000 g
<b>KHP70**</b>		4-70	50	-	375 mm	3.000 g
<b>KHP240**</b>		16-240	120	-	480 mm	6.250 g

\*Pribor: Transportna torba iz umetne mase

\*\*Pribor: Transportna torba iz umetne mase + kalupi





**Kalupi za ročne hidravlične klešče D31**

TRACON		Cu  mm <sup>2</sup>	Al  mm <sup>2</sup>
<b>D31-4</b>	KZ 4	4	-
<b>D31-6</b>	KZ 5	6	4
<b>D31-10</b>	KZ 6	10	6
<b>D31-16</b>	KZ 8	16	10
<b>D31-25</b>	KZ 10	25	16
<b>D31-35</b>	KZ 12	35	25
<b>D31-50</b>	KZ 14	50	35
<b>D31-70</b>	KZ 16	70	50
<b>D31-95</b>	KZ 18	95	70





**Kalupi za ročne hidravlične klešče D52F**

TRACON	Cu  mm <sup>2</sup>	Al  mm <sup>2</sup>
<b>D52F-1016</b>	10-16	10
<b>D52F-2535</b>	25-35	16-25
<b>D52F-5070</b>	50-70	50-35
<b>D52F-95120</b>	95-120	70-95
<b>D52F-150</b>	150	120
<b>D52F-185</b>	185	150
<b>D52F-240</b>	240	185





**Kalupi za ročne hidravlične klešče D51**

TRACON		Cu  mm <sup>2</sup>	Al  mm <sup>2</sup>
<b>D51-10-120</b>	KZ 6	10	6
	KZ 20	120	95
<b>D51-16-70</b>	KZ 8	16	10
	KZ 16	70	50
<b>D51-25-95</b>	KZ 10	25	16
	KZ 18	95	70
<b>D51-35-50</b>	KZ 12	35	25
	KZ 14	50	35
<b>D51-150</b>	KZ 22	150	120
<b>D51-185</b>	KZ 25	185	150











**Kalupi za ročne hidravlične klešče C120F**

TRACON	Cu  mm <sup>2</sup>	Al  mm <sup>2</sup>
<b>C120F-16</b>	16	-
<b>C120F-25</b>	25	16
<b>C120F-35</b>	35	25
<b>C120F-50</b>	50	35
<b>C120F-70</b>	70	50
<b>C120F-95</b>	95	70
<b>C120F-120</b>	120	95
<b>C120F-150</b>	150	120
<b>C120F-185</b>	185	150
<b>C120F-240</b>	240	185
<b>C120F-300</b>	300	240
<b>C120F-400</b>	400	300



## Akumulatorske hidravlične klešče za stiskanje - dobava brez kalupa



TRACON		 mm <sup>2</sup>	 kN max			 m
D31E		4-95	35	360°	200 mm	1.550 g
D55E		10-185	55	340°	315 mm	3.250 g
D62E		6-240	62	340°	320 mm	3.550 g

Pripadajoča oprema:

- Polnilnik akumulatorjev (Tracon koda za kasnejše naročanje: AKKUT1)
- Akumulator (Tracon koda za kasnejše naročanje: AKKU1)
- Kovinska transportna torba





### Kalupi za akumulatorske hidravlične klešče D62E

TRACON		Cu  mm <sup>2</sup>	Al  mm <sup>2</sup>
D62-10	KZ 6	10	6
D62-16	KZ 8	16	10
D62-25	KZ 10	25	16
D62-35	KZ 12	35	25
D62-50	KZ 14	50	35
D62-70	KZ 16	70	50
D62-95	KZ 18	95	70
D62-120	KZ 20	120	95
D62-150	KZ 22	150	120
D62-185	KZ 25	185	150
D62-240	KZ 28	240	185
D62-300	KZ 32	300	240





### Kalupi za akumulatorske hidravlične klešče D31E

TRACON		Cu  mm <sup>2</sup>	Al  mm <sup>2</sup>
D31-4	KZ 4	4	-
D31-6	KZ 5	6	4
D31-10	KZ 6	10	6
D31-16	KZ 8	16	10
D31-25	KZ 10	25	16
D31-35	KZ 12	35	25
D31-50	KZ 14	50	35
D31-70	KZ 16	70	50
D31-95	KZ 18	95	70







### Kalupi za akumulatorske hidravlične klešče D55E

TRACON		Cu  mm <sup>2</sup>	Al  mm <sup>2</sup>
D51-10-120	KZ 6	10	6
	KZ 20	120	95
D51-16-70	KZ 8	16	10
	KZ 16	70	50
D51-25-95	KZ 10	25	16
	KZ 18	95	70
D51-35-50	KZ 12	35	25
	KZ 14	50	35
D51-150	KZ 22	150	120
D51-185	KZ 25	185	150





## Polnilnik akumulatorjev

TRACON		 V	 Ah	
AKKUT1	230 V AC	18 V	2100 mAh	Li-ion



 Razlaga piktogramov **B/O**









## Akumulator

TRACON	 V	 Ah	
AKKU1	18 V	2000 mAh	Li-ion





**Akumulatorske hidravlične klešče za stiskanje, s kalupi, v kovčku**









<b>TRACON</b>	 mm <sup>2</sup>	 kN max	 350°	 420 mm	 V	 Ah		 V AC	 m
<b>DK60E</b>	16-300	60	350°	420 mm	18 V	2×3200 mAh	Li-ion	230 V AC	4.900 g

Sila stiskanja:	60 kN
Predhod:	17 mm
Število stiskanj z enim polnjenjem:	320 stiskanj (Cu 150 mm <sup>2</sup> )
Čas stiskanja:	3-6 s (odvisno od preseka vodnika)
Napetost akumulatorja:	18 V
Kapaciteta akumulatorja:	3,2 Ah
Masa (z akumulatorjem):	4,9 kg
Čas polnjenja:	1 ura
Kovček:	kovček iz umetne mase

Dodatki (priloženi dobavi):	
Kalupi za stiskanje:	16, 25, 35, 50, 70, 95, 120, 150, 185, 240, 300 mm <sup>2</sup>
Akumulator:	2 kom
Polnilnik:	1 kom
Tesnilni obroč delovnega valja:	1 komplet
Tesnilni obroč varnostnega ventila:	1 komplet



## Akumulatorske hidravlične škarje za rezanje, v kovčku

<b>TRACON</b>	 <b>d<sub>max</sub></b>	 <b>kN<sub>max</sub></b>	 <b>360°</b>	 <b>610 mm</b>	 <b>18 V</b>	 <b>2×5000 mAh</b>	 <b>Li-ion</b>	 <b>230 V AC</b>	 <b>8.550 g</b>
<b>DKV105</b>	105 mm	120	360°	610 mm	18 V	2×5000 mAh	Li-ion	230 V AC	8.550 g

Sila rezanja:	120 kN
Predhod:	108 mm
Območje rezanja:	Ø 150 mm za Cu/Al vodnike in kable
Število rezov z enim polnjenjem:	~70 rezov
Čas rezanja:	15-30 s (odvisno od preseka vodnika/kabla in njegovega materiala)
Napetost akumulatorja:	18 V
Kapaciteta akumulatorja:	5,0 Ah
Čas polnjenja:	1 ura
Mere:	610 × 430 × 85 mm
Kovček:	kovček iz umetne mase
Dodatki (priloženi dobavi):	
Akumulator:	2 kom
Polnilnik:	1 kom
Tesnilni obroč delovnega valja:	1 komplet
Tesnilni obroč varnostnega ventila:	1 komplet





**Hidravlična štanca in stiskalnica**



<b>TRACON</b>	<b>kN max</b>	<b>Imax</b>	<b>a</b>	<b>m</b>
<b>HKS-15</b>	150 kN	max. 2-3 mm	25 mm	6.2 kg

Dodatna oprema stiskalnice: • kalupi Ø21,8mm; Ø27,6mm; Ø34,1mm; Ø42,7mm; Ø48,7mm; Ø60,5mm; □32×32mm • Prenosna torba

Uporablja se za štančanje lukenj v kovinskih omarah. S pomočjo tega orodja se omara enostavno opremi s signalnimi lučkami, tipkami, ročnimi stikali ter tesnilnimi uvodnicami za uvod kablov v kovinske omare.



**Posebej se lahko naročijo naslednji kalupi (niso sestavni del orodja HKS-15):**



<b>TRACON</b>		
<b>HKS-15-20</b>	MG20 tesnilna uvodnica	Ø20 mm
<b>HKS-15-22</b>	Tipka Ø22 mm	Ø22 mm
<b>HKS-15-25</b>	MG25 tesnilna uvodnica	Ø25 mm
<b>HKS-15-32</b>	MG32 tesnilna uvodnica	Ø32 mm
<b>HKS-15-40</b>	MG40 tesnilna uvodnica	Ø40 mm
<b>HKS-15-50</b>	MG50 tesnilna uvodnica	Ø50 mm
<b>HKS-15-63</b>	MG63 tesnilna uvodnica	Ø63 mm
<b>HKS-15-PG13,5</b>	PG13,5 tesnilna uvodnica	Ø20 mm
<b>HKS-15-PG16</b>	PG16 tesnilna uvodnica	Ø23,5 mm
<b>HKS-15-PG21</b>	PG21 tesnilna uvodnica	Ø29,5 mm
<b>HKS-15-PG29</b>	PG29 tesnilna uvodnica	Ø36 mm
<b>HKS-15-PG36</b>	PG36 tesnilna uvodnica	Ø46 mm
<b>HKS-15-PG42</b>	PG42 tesnilna uvodnica	Ø51 mm
<b>HKS-15-PG48</b>	PG48 tesnilna uvodnica	Ø59 mm
<b>HKS-15-43×43</b>	48×48 mm štirioglati instrument	□43×43 mm
<b>HKS-15-68×68</b>	72×72 mm štirioglati instrument	□68×68 mm
<b>HKS-15-92×92</b>	96×96 mm štirioglati instrument	□92×92 mm
<b>HKS-15-BSZ10</b>	Nadomestni mali vijak 105 mm	max. 2-3 mm

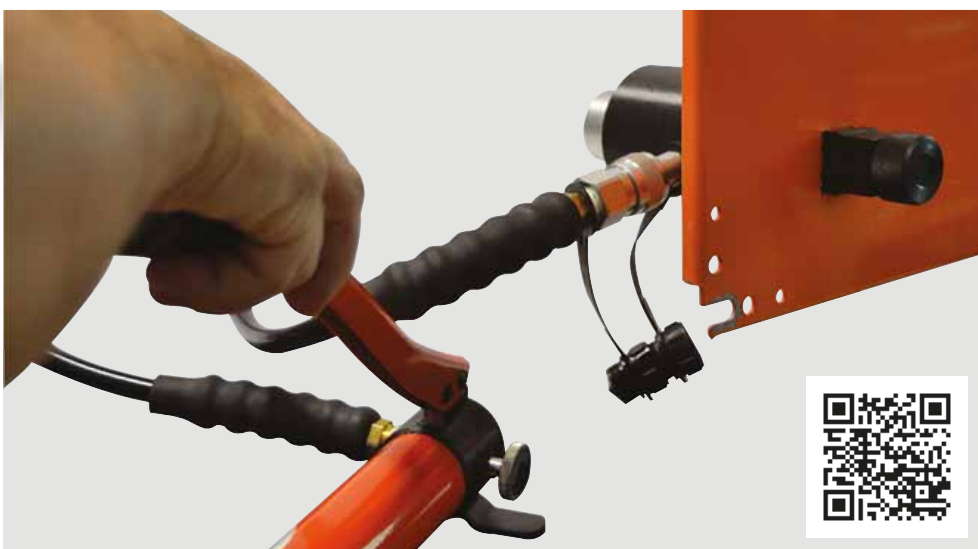

## Klešče s prestavnim razmerjem za rezanje Cu in Al vodnikov

TRACON	d <sub>max</sub> 	NYN 	NYN 	NYCWY 	NAYY 	NAYY 	AYCWY 
<b>RKV300</b>	35 mm	max. 4×50	max. 1×240	max. 4×50/25	max. 4×70	max. 1×300	max. 4×50/25
<b>RKV700</b>	60 mm	max. 4×95	max. 1×240	max. 4×95/50	max. 4×120	max. 1×300	max. 4×95/35
<b>RKV1000</b>	95 mm	–	–	max. 4×240/120	max. 4×240	max. 1×500	–



RKV300



RKV700



teleskopski ročaj

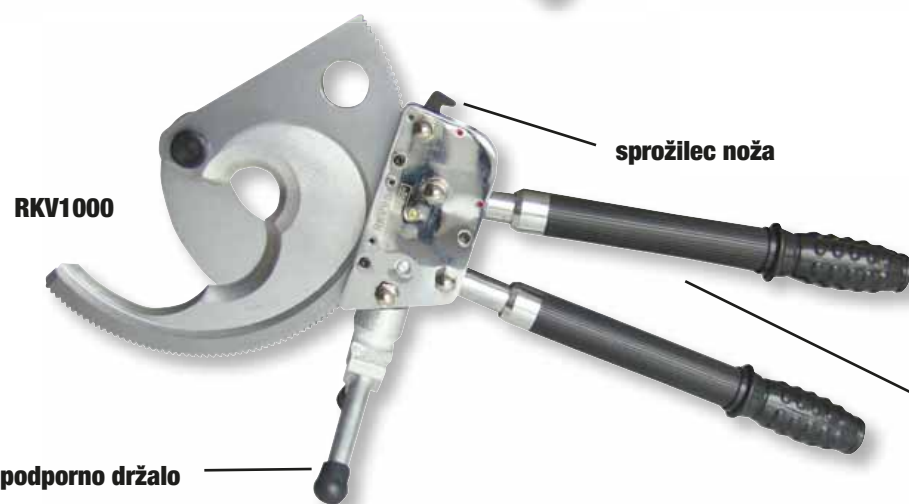

RKV1000

sprožilec noža



teleskopski ročaj





**Klešče za rezanje Cu in Al vodnikov**

TRACON	A <sub>max</sub> 	d <sub>max</sub> 		m 
<b>CC22</b>	16 mm <sup>2</sup>	5,5 mm	150 mm	190 g
<b>CC38</b>	25 mm <sup>2</sup>	6,5 mm	210 mm	350 g
<b>CC60</b>	35 mm <sup>2</sup>	8 mm	230 mm	510 g
<b>CC80</b>	70 mm <sup>2</sup>	9 mm	235 mm	510 g
<b>CC100</b>	100 mm <sup>2</sup>	15 mm	320 mm	500 g
<b>CC250</b>	250 mm <sup>2</sup>	17 mm	600 mm	1250 g
<b>CC500</b>	500 mm <sup>2</sup>	25 mm	800 mm	2850 g



**Klešče - izolirane (1000 V)**



TRACON		m 	
<b>KF-1000</b>	160 mm	230 g	Kombinirke
<b>KF-1000-2</b>	200 mm	370 g	Kombinirke
<b>KB-1000</b>	160 mm	230 g	Klešče za snemanje izolacije
<b>KC-1000</b>	160 mm	210 g	Bočne ščipalke
<b>KL-1000</b>	160 mm	230 g	Telefonske klešče - ravne

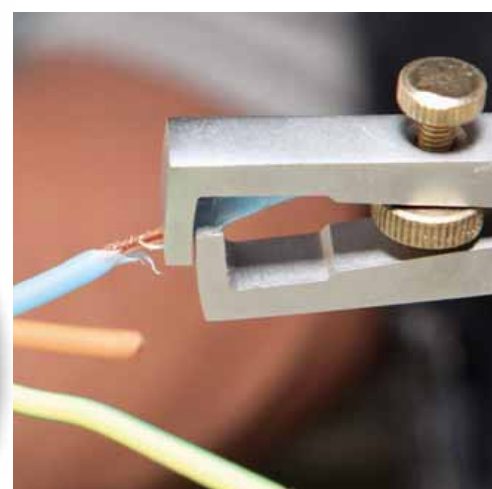

**RELEVANT STANDARD  
EN 60900**



## Izvijači SD - izolirani (1000 V)



TRACON		
SD375F		3×75 mm
SD4100F		4×100 mm
SD5125F		5×125 mm
SD6100F		6×100 mm
SD6125F		6×125 mm
SD6150F		6×150 mm
SD375S		3×75 mm (PH0)
SD4100S		4×100 mm
SD5125S		5×125 mm (PH1)
SD6100S		6×100 mm (PH2)
SD6125S		6×125 mm (PH2)
SD6150S		6×150 mm (PH2)



RELEVANT STANDARD  
EN 60900



## Izvijač PZ, križni, kombinirani - izolirani (1000 V)

TRACON		
SDDK4100S		4×100 mm
SDDK5125S		5×125 mm (PZ1)
SDDK6150S		6×150 mm (PZ2)

Glava izvijačev SDDK je oblikovana tako, da omogoča zategovanje specialnih vijakov v števcih, odklopnikih, magnetnih stikalih, znamke Tracon. Ti vijaki imajo glavo v obliki zvezde (PZ) in se lahko zategujejo tudi s ploskimi izvijači. Izvijač SDDK s kombiniranim profilom združuje prednosti ploskih in križnih izvijačev, kar olajša in zagotavlja varnejše zategovanje.





VDE TEST REPORT NO.:  
40011797



RELEVANT STANDARD  
EN 60900





## Set izvijačev, izoliran na 1000V

TRACON		
KSET1000	1.0 × 5.5 × 125 mm	PH2 × 100 mm
	0.8 × 4.0 × 100 mm	PH1 × 80 mm
	0.4 × 2.5 × 75 mm	PH0 × 60 mm



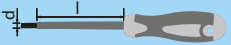

## Izvijači SD - CrV

### Ploščati izvijači (SL)

TRACON			
<b>SD2575SL</b>	SL 2,5 × 75 mm	CrV	52 g
<b>SD40100SL</b>	SL 4,0 × 100 mm	CrV	58 g
<b>SD55125SL</b>	SL 5,5 × 125 mm	CrV	90 g
<b>SD65150SL</b>	SL 6,5 × 150 mm	CrV	127 g



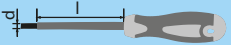

### Križni izvijači (Philips, PH)

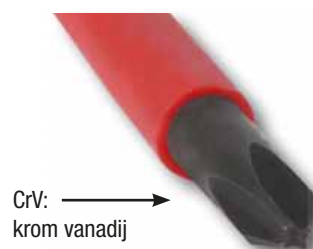
TRACON			
<b>SD3060PH0</b>	PH0 3,0 × 60 mm	CrV	49 g
<b>SD5080PH1</b>	PH1 5,0 × 80 mm	CrV	73 g
<b>SD60100PH2</b>	PH2 6,0 × 100 mm	CrV	102 g
<b>SD80150PH3</b>	PH3 8,0 × 150 mm	CrV	178 g

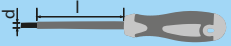

### Križni izvijači (Pozidriv, PZ)



TRACON			
<b>SD3060PZ0</b>	PZ0 3,0 × 60 mm	CrV	49 g
<b>SD5080PZ1</b>	PZ1 5,0 × 80 mm	CrV	73 g
<b>SD60100PZ2</b>	PZ2 6,0 × 100 mm	CrV	102 g
<b>SD80150PZ3</b>	PZ3 8,0 × 150 mm	CrV	178 g



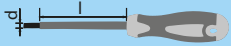

## Izvijači SD - CrV

## Kombinirani izvijači (SLPZ)

TRACON			
<b>SD5080SLPZ1</b>	SL/PZ1 5,0 × 80 mm	CrV	73 g
<b>SD60100SLPZ2</b>	SL/PZ2 6,0 × 100 mm	CrV	102 g



CrV: →  
krom vanadij

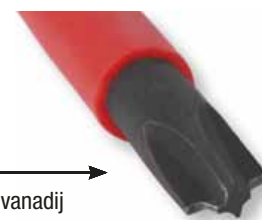



SD5080SLPZ1



SD60100SLPZ2



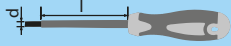

## 8 delni set izvijačev v priročni torbici

TRACON			
<b>SDSETOF8</b>			
-	<b>SD2575SL</b>	SL 2,5 × 75 mm	CrV 52 g
-	<b>SD40100SL</b>	SL 4,0 × 100 mm	CrV 58 g
-	<b>SD55125SL</b>	SL 5,5 × 125 mm	CrV 90 g
-	<b>SD65150SL</b>	SL 6,5 × 150 mm	CrV 127 g
-	<b>SD3060PH0</b>	PH0 3,0 × 60 mm	CrV 49 g
-	<b>SD5080PH1</b>	PH1 5,0 × 80 mm	CrV 73 g
-	<b>SD60100PH2</b>	PH2 6,0 × 100 mm	CrV 102 g
-	<b>SD80150PH3</b>	PH3 8,0 × 150 mm	CrV 178 g

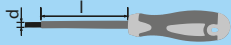

## 12 delni set izvijačev v priročni torbici

TRACON			
<b>SDSETOF12</b>			
-	<b>SD2575SL</b>	SL 2,5 × 75 mm	CrV 52 g
-	<b>SD40100SL</b>	SL 4,0 × 100 mm	CrV 58 g
-	<b>SD55125SL</b>	SL 5,5 × 125 mm	CrV 90 g
-	<b>SD65150SL</b>	SL 6,5 × 150 mm	CrV 127 g
-	<b>SD3060PH0</b>	PH0 3,0 × 60 mm	CrV 49 g
-	<b>SD5080PH1</b>	PH1 5,0 × 80 mm	CrV 73 g
-	<b>SD60100PH2</b>	PH2 6,0 × 100 mm	CrV 102 g
-	<b>SD80150PH3</b>	PH3 8,0 × 150 mm	CrV 178 g
-	<b>SD3060PZ0</b>	PZ0 3,0 × 60 mm	CrV 49 g
-	<b>SD5080PZ1</b>	PZ1 5,0 × 80 mm	CrV 73 g
-	<b>SD60100PZ2</b>	PZ2 6,0 × 100 mm	CrV 102 g
-	<b>SD80150PZ3</b>	PZ3 8,0 × 150 mm	CrV 178 g





**PROSIMO, ODČITAJTE KODO!**

- Oglejte si novosti
- Bodite na tekočem

**Naša paleta izdelkov se nenehno širi!  
Katalog odraža stanje aprila 2021.  
Za ažurne informacije obiščite  
našo spletno stran!**

### Klešče za napenjanje in rezanje vezic

TRACON		
TG007	2.2-8 mm	220 g
TG008	2.2-4.8 mm	320 g



TG008







TG007

### Klešče za napenjanje in rezanje jeklenih vezic

TRACON		
TGF	4,6 - 7,9mm	620 g





### Predvleka za kable in vodnike

TRACON			
TBSZ-5	5 m		Plastična vrv za predvleko s kovinsko glavo
TBSZ-10	10 m	∅ = 3 mm	
TBSZ-20	20 m		
TBSZS-5	5 m		Spiralna kovinska vrv za predvleko
TBSZS-10	10 m	∅ = 3.2 mm	
TBSZS-20	20 m		
TBSZF-5	5 m		Kovinska vrv- ploščata za predvleko
TBSZF-10	10 m	d = 3.2 mm	
TBSZF-20	20 m		



TBSZS



TBSZF



TBSZ



## Toplozračne pištrole

TRACON	$U_n$				
HLF-02	230 V AC	1.000/2.000 W	350/600 °C	1450 g	300 / 500 l/min

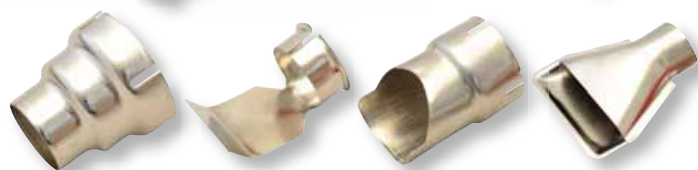

## TERMIČNI STEZNI PROIZVODI



D/2-D/13

## Orodje za odstranjevanje izolacije, z dvojnimi rezilom

TRACON		
KB-UNI	160 mm	70 g



## Orodje za odstranjevanje izolacije, s kljukastim rezilom

TRACON		max. $\varnothing$	
KBY	200 mm	12 mm	95 g



### PROSIMO, ODČITAJTE KODO!

- Oglejte si novosti
- Bodite na tekočem

Naša paleta izdelkov se nenehno širi!  
 Katalog odraža stanje aprila 2021.  
 Za ažurne informacije obiščite  
 našo spletno stran!



UTILK Tapetniški noži

TRACON					
UTILK01			168×35×18 mm l=110; d=18; x=0,7 (×4)	Zn + TPR	250 g
UTILK02			178×33×19 mm l=110; d=18; x=0,7 (×1)	Zn + TPR	250 g
UTILK03			155×33×19 mm l=110; d=18; x=0,7 (×1)	ABS + TPR	125 g
UTILK04			175×41×27 mm l = 62; d=19; x=0,6 (×1)	Al + TPR	194 g
UTILK05			149×19×17 mm l=90; d=12.5; x=0,2mm; x1	ABS	59 g
UTILK06			140×23×18 mm l=90; d=12.5; x=0,2mm; x1	Al	80 g
UTILK07			145×22×18 mm l=82; d=9; x=0,6mm; x1	TPR	54 g
UTILK08			145×21×17 mm l=82; d=9; x=0,6mm; x1	ABS	50 g

**UTILK01**  
Cink prijemalo z gumijasto oblogo

**UTILK05**  
Fleksibilna SK4 rezila z vzmetno pritrditvijo, ABS prijemalo

**UTILK02**  
Prijemalo iz cinkove zlitine z gumijasto oblogo

**UTILK06**  
Fleksibilna SK4 rezila s fiksno pritrditvijo, aluminijasto prijemalo



**UTILK03**  
ABS prijemalo z gumijasto oblogo

**UTILK07**  
Ozka SK4 rezila z vzmetno pritrditvijo, obešalo uho, TPR gumijasto prijemalo

**UTILK04**  
Nož s trapeznim rezilom, ALU prijemalo z gumijasto oblogo

**UTILK08**  
Ozka SK4 rezila z vzmetno pritrditvijo, ABS prijemalo

## BD Rezila

TRACON		
<b>BD02</b>	l=90; d=12,5; x=0,2mm; (×30)	38 g
<b>BD05</b>	l=110; d=18; x=0,5mm; (×10)	105 g
<b>BD06</b>	l=110; d=18; x=0,6mm; (×10)	115 g
<b>BD07</b>	l=110; d=18; x=0,7mm; (×10)	125 g
<b>BDT06</b>	l=62; d=19; x=0,6mm; (×10)	92 g
<b>BD069</b>	l=82; d=9; x=0,6mm; (×10)	38 g

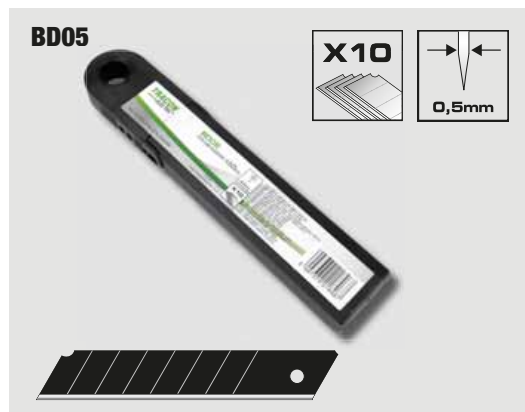

- Ekstremno ostro. • 5× vzdržljivejše, kot običajno rezilo. • Nerjaveče jeklo.
- Ostrina rezila je izdelana z večstopenjsko lasersko izostritvijo, ki zagotavlja večjo trdnost.
  - Za posebno težke naloge. • Orodno jeklo SK4.



**PROSIMO, ODČITAJTE KODO!**

- Oglejte si novosti
- Bodite na tekočem

**Naša paleta izdelkov se nenehno širi!**  
**Katalog odraža stanje aprila 2021.**  
**Za ažurne informacije obiščite**  
**našo spletno stran!**