



Klasické sťahovacie pásky 2



Klasické sťahovacie pásky farebné 3



Sťahovacie pásky s kovovým jazýčkom, čierne 4



Sťahovacie pásky pre viacnásobné použitie 5



Sťahovacie pásky perličkové, rozpínacie 5



Sťahovacie pásky so zvýšenou tepelnou odolnosťou 6



Sťahovacie pásky nehorľavé 6



Sťahovacia páska so zastrkávacou hlavou 6



Sťahovacie pásky so štítkom 7



Oceľové sťahovacie pásky 7



Sťahovacie pásky so samopínacou pätkou 8



Páska na zväzovanie káblov na suchý zips 9



Samolepiaca príchytka káblov 9



Skrutkovacie pätky k sťahovacím páskam 10



Zatlačacie hmoždinky k sťahovacím páskam 11



Príchytka na káble, s klincom 12



Samopínacie príchytka 12



Hmoždinky na uchytienie káblov 13



Hmoždinky s profilovými skrutkami 14



Hmoždinky lemované, so šesťhrannou skrutkou 14



Zatíkáacie hmoždinky do sadrokartónu 14



Hmoždinky nylon s vysokou zaťažiteľnosťou 15



Hmoždinky do sadrokartónu 15



Hmoždinky so zatíkácou skrutkou 16



Hmoždinky lemované 17



Lanové očnice 18



Háky "S" 19



Lanové svorky, profil "U" 19



Lanové svorky dvoj-skrutkové "duplex" 20



Karabíny s pružinou 21



Napínacie skrutky 22



Káblové zväzovacie špirály 23



Pletená zväzovacia sieťka 23



Plomby 24



Plomba na meracie prístroje 24

C/O Vysvetlenie piktogramov hlavičky tabuliek

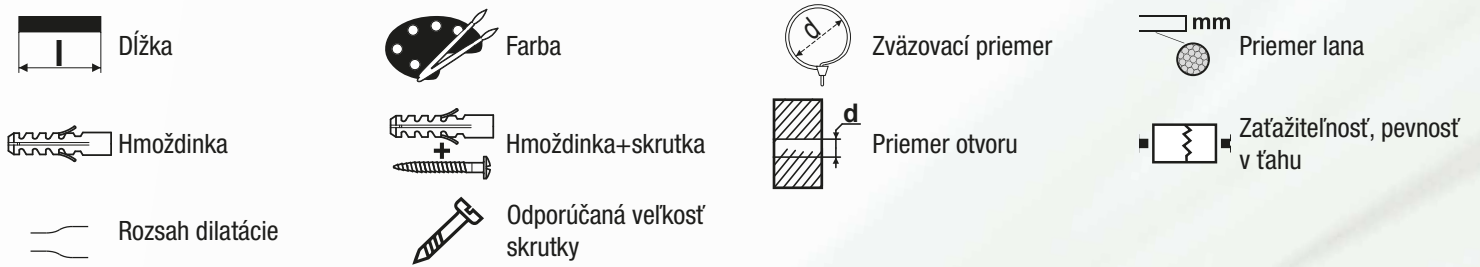

C/O Piktogramy technických parametrov

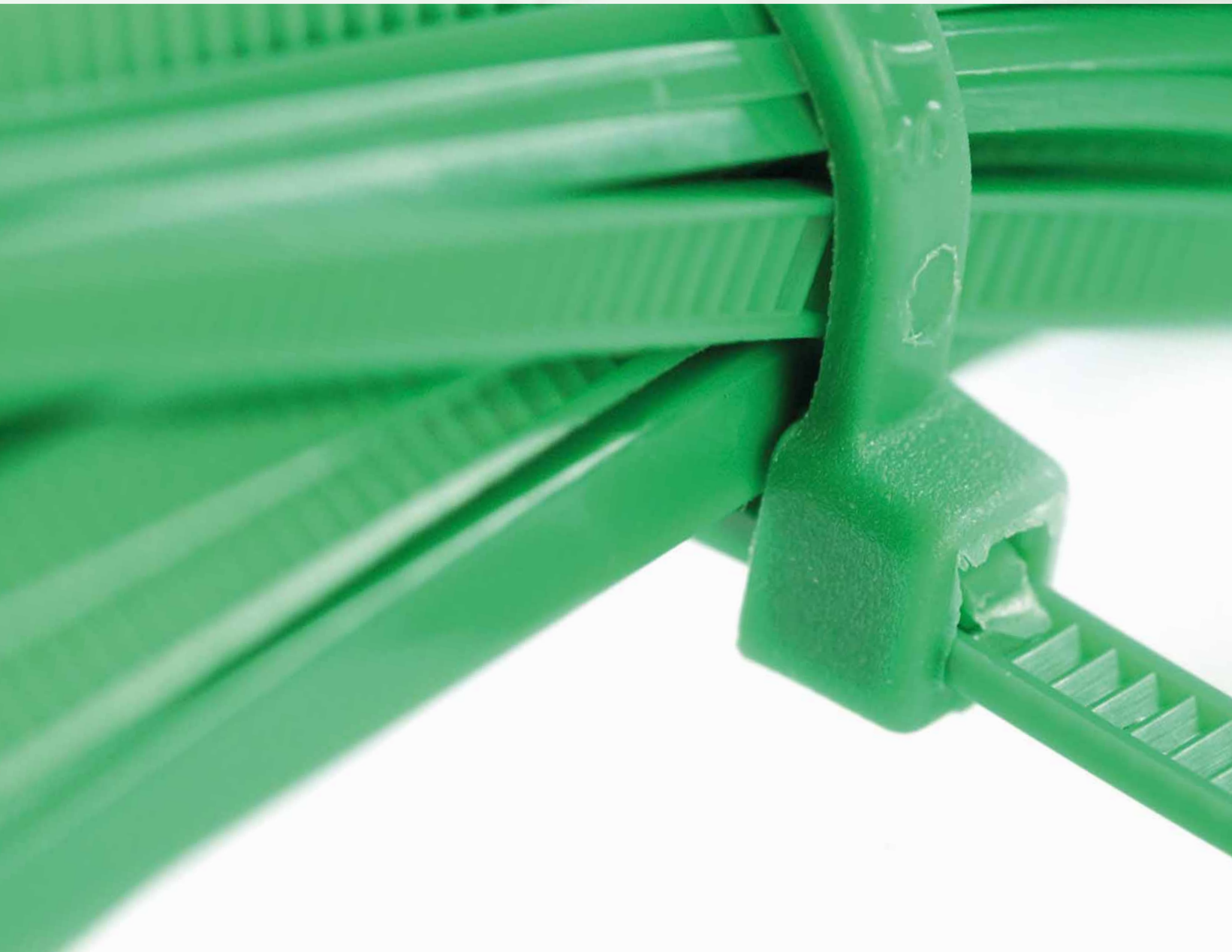

Klasické sťahovacie pásky

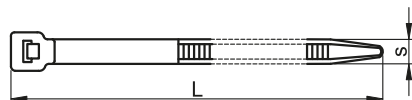

| TRACON | | | | | | | |
|---------------|--|---------------|--|----------------|------------|-------|--|
| 80PR | | 81PR | | 75 × 2.2 mm | 0.75-15 mm | 35 N | |
| 120PR | | 121PR | | 98 × 2.5 mm | 1-21 mm | 45 N | |
| 130PR | | 131PR | | 135 × 2.6 mm | 1-32 mm | 45 N | |
| 150PR | | 151PR | | 140 × 3.6 mm | 2-36 mm | 80 N | |
| 160PR | | 161PR | | 160 × 2.6 mm | 1-40 mm | 45 N | |
| 180PR | | 181PR | | 180 × 7.8 mm | 3.5-45 mm | 250 N | |
| 200PR | | 201PR | | 200 × 2.6 mm | 1-52 mm | 45 N | |
| 170PR | | 171PR | | 200 × 3.6 mm | 2-50 mm | 80 N | |
| 190PR | | 191PR | | 200 × 4.8 mm | 3-50 mm | 110 N | |
| 250PR | | 251PR | | 250 × 4.8 mm | 3-68 mm | 110 N | |
| 280PR | | 281PR | | 280 × 8.0 mm | 4-65 mm | 180 N | |
| 230PR | | 231PR | | 290 × 3.6 mm | 2-80 mm | 80 N | |
| 210PR | | 211PR | | 290 × 4.8 mm | 3.5-79 mm | 110 N | |
| 300PR | | 301PR | | 300 × 7.8 mm | 5-80 mm | 250 N | |
| 220PR | | 221PR | | 360 × 4.8 mm | 3.5-103 mm | 110 N | |
| 260PR | | 261PR | | 365 × 7.8 mm | 8-100 mm | 250 N | |
| 370PR | | 371PR | | 370 × 3.6 mm | 5-108 mm | 80 N | |
| 430PR | | 431PR | | 430 × 4.8 mm | 3.5-115 mm | 110 N | |
| 450PR | | 451PR | | 450 × 7.8 mm | 35-130 mm | 250 N | |
| 530PR | | 531PR | | 550 × 8 mm | 10-160 mm | 250 N | |
| 760PR | | 761PR | | 780 × 9 mm | 35-233 mm | 350 N | |
| 850PR | | 851PR | | 850 × 12.6 mm | 40-255 mm | 450 N | |
| 1000PR | | 1001PR | | 1000 × 12.6 mm | 40-302 mm | 450 N | |
| 270PR | | 271PR | | 260 × 2.5 mm | 3-73 mm | 45 N | |
| 550PR | | 551PR | | 550 × 4.6 mm | 4-160 mm | 110 N | |
| 610PR | | 611PR | | 610 × 8.8 mm | 9-181 mm | 350 N | |
| 580PR | | 581PR | | 580 × 12.4 mm | 9-168 mm | 450 N | |



RELEVANT STANDARD
EN 62275



B/18

TG008

TG007



Vlastnosti:

Trvale odolné voči olejom, benzínu, derivátom uhľovodíka, syntetickým rozpúšťadlám, plesniam, alkoholom.

Krátkodobo odolné voči organickým kyselinám, zásadám, anorganickým soľam a organickým látkam.

Nie sú odolné voči anorganickým kyselinám a oxidačným prípravkom.

Klasické sťahovacie pásky farebné

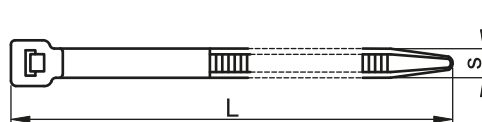
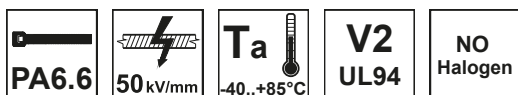

| TRACON | | | | |
|--------------|--|--------------|-----------|-------|
| 120K | | 98 × 2.5 mm | 1-21 mm | 45 N |
| 150P | | 140 × 3.6 mm | 2-36 mm | 80 N |
| 150Z | | 140 × 3.6 mm | 2-36 mm | 80 N |
| 200K | | 200 × 2.6 mm | 1-52 mm | 45 N |
| 170K | | 200 × 3.6 mm | 2-50 mm | 80 N |
| 170P | | 200 × 3.6 mm | 2-50 mm | 80 N |
| 190K | | 200 × 4.8 mm | 3-50 mm | 110 N |
| 230NZ | | 290 × 3.6 mm | 2-80 mm | 80 N |
| 170Z | | 203 × 3.6 mm | 2 - 52 mm | 80 N |
| 190Z | | 203 × 4.6 mm | 2 - 52 mm | 110 N |

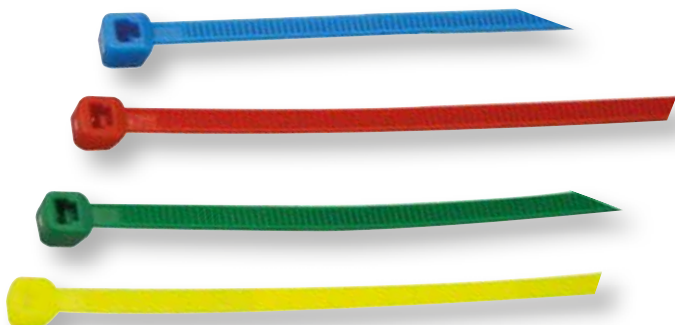

RELEVANT STANDARD
EN 62275

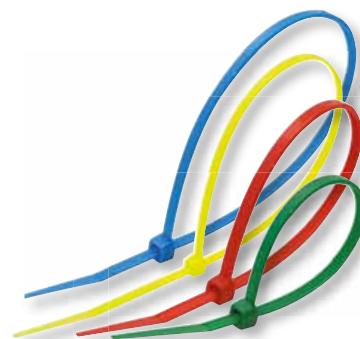

Sťahovacie pásky s kovovým jazýčkom, prírodné

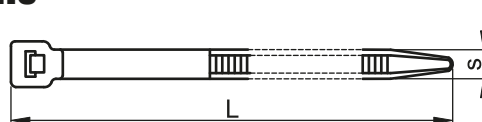
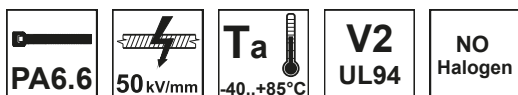

| TRACON | | | |
|-------------|--|--------------|------------|
| T92 | | 92 × 2.4 mm | 2-16 mm |
| T140 | | 140 × 3.6 mm | 2-29 mm |
| T186 | | 186 × 4.8 mm | 3.5-45 mm |
| T200 | | 200 × 2.4 mm | 2-50 mm |
| T208 | | 208 × 3.6 mm | 2-50 mm |
| T281 | | 281 × 3.6 mm | 2-76 mm |
| T293 | | 293 × 4.8 mm | 3.5-78 mm |
| T338 | | 338 × 7.6 mm | 3.5-120 mm |
| T360 | | 360 × 4.8 mm | 3.5-102 mm |



Sťahovacie pásky s kovovým jazýčkom, čierne

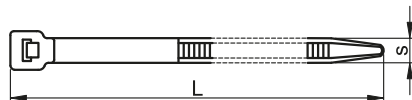

Vysvetlivky piktogramov

C/0

| TRACON | | | | |
|--------|--|--------------|------------|-------|
| TU92 | | 92 × 2.4 mm | 2-16 mm | 35 N |
| TU140 | | 140 × 3.6 mm | 2-29 mm | 75 N |
| TU186 | | 186 × 4.8 mm | 3.5-45 mm | 110 N |
| TU200 | | 200 × 2.4 mm | 2-50 mm | 35 N |
| TU208 | | 208 × 3.6 mm | 2-50 mm | 75 N |
| TU281 | | 281 × 3.6 mm | 2-76 mm | 75 N |
| TU293 | | 293 × 4.8 mm | 3.5-78 mm | 110 N |
| TU338 | | 338 × 7.6 mm | 3.5-120 mm | 110 N |
| TU360 | | 360 × 4.8 mm | 3.5-102 mm | 110 N |



Sťahovacie pásky s dvoma jazýčkami

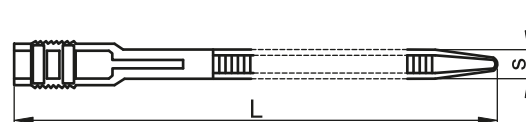

| TRACON | | | | |
|--------|--|--------------|----------|-------|
| 132-12 | | 132 × 9.0 mm | 4-27 mm | 120 N |
| 180-12 | | 180 × 9.0 mm | 5-45 mm | 150 N |
| 265-12 | | 260 × 9.0 mm | 25-65 mm | 250 N |
| 300-12 | | 300 × 9.0 mm | 25-80 mm | 225 N |
| 360-12 | | 350 × 9.0 mm | 25-93 mm | 250 N |



RELEVANT STANDARD
EN 62275

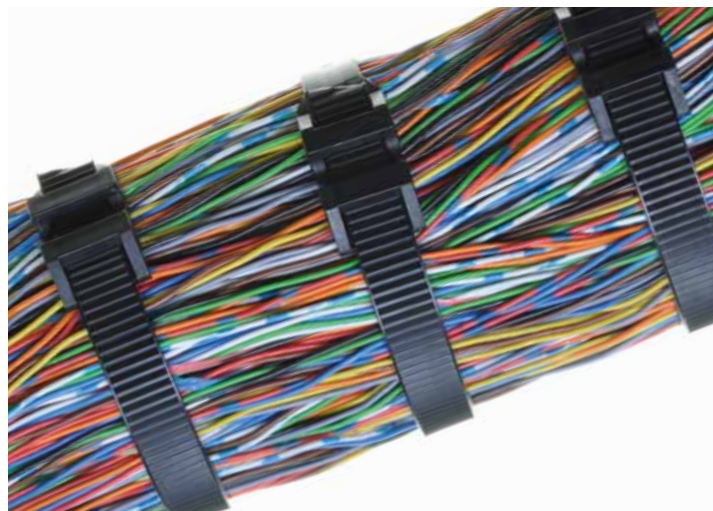

Sťahovacie pásky pre viacnásobné použitie

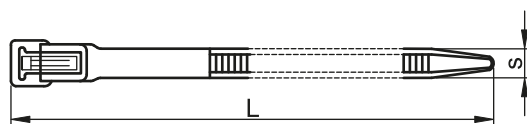
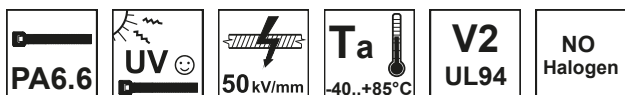

| TRACON | | | | |
|---------------|---------------|--------------|-----------|---------|
| 180-NY | 181-NY | 200 × 7.5 mm | 10-50 mm | 10-45 N |
| 260-NY | 261-NY | 250 × 7.5 mm | 10-65 mm | 10-45 N |
| 280-NY | 281-NY | 300 × 7.5 mm | 10-70 mm | 10-45 N |
| 350-NY | 351-NY | 350 × 8 mm | 10-120 mm | 10-45 N |



Sťahovacie pásky perličkové, rozpínacie

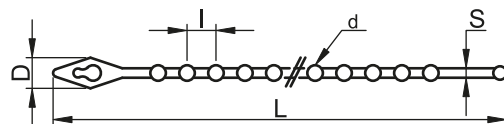
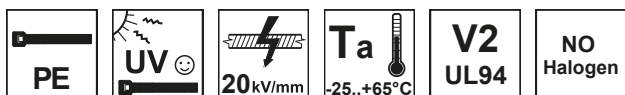





| TRACON | | L × S (mm) | d (mm) | D (mm) | I (mm) | | |
|----------------|----------------|------------|--------|--------|--------|-----------|------|
| 100N-GY | 100F-GY | 1.2 × 100 | 2.5 | 4.85 | 3 | 3 - 25 mm | 45 N |
| 120N-GY | 120F-GY | 120 × 1.3 | 2.5 | 5.5 | 3 | 6-25 mm | 40 N |
| 150N-GY | 150F-GY | 150 × 2 | 3 | 7.5 | 4.5 | 8-35 mm | 40 N |
| 160N-GY | 160F-GY | 1.7 × 150 | 2.6 | 7.73 | 4 | 4 - 38 mm | 40 N |
| 180N-GY | 180F-GY | 180 × 2 | 3 | 7.5 | 4.5 | 8-45 mm | 40 N |
| 200N-GY | 200F-GY | 1.8 × 200 | 2.5 | 7.63 | 5 | 5 - 59 mm | 40 N |

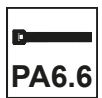

RELEVANT STANDARD
EN 62275

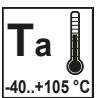
Sťahovacie pásky so zvýšenou tepelnou odolnosťou

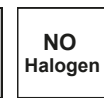





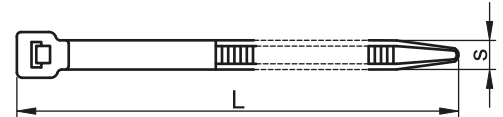
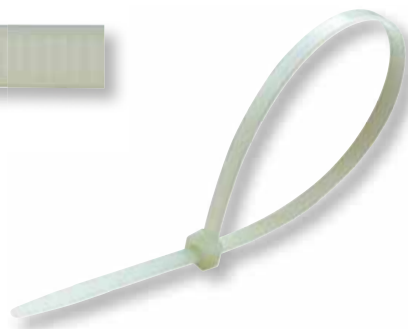

Vysvetlivky piktogramov
C/O

TRACON











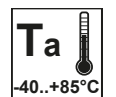
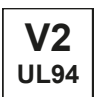



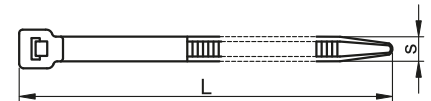

RELEVANT STANDARD
EN 62275

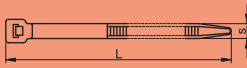
Sťahovacie pásky nehorľavé

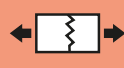











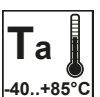

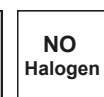

| TRACON |  |  |  |
|---|--|--|--|
| 150L  | 3.6 × 150mm | 4 - 36 mm | 80 N |
| 200L  | 4.6 × 200mm | 4 - 52 mm | 110 N |
| 300L  | 4 × 300mm | 4 - 81 mm | 110 N |
| 380L  | 7.6 × 380mm | 9 - 108 mm | 250 N |



Sťahovacia páska so zastrkávacou hlavou

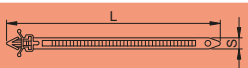





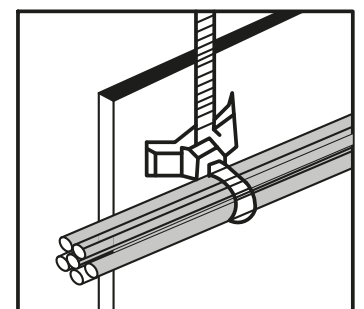
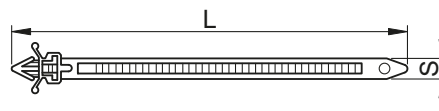
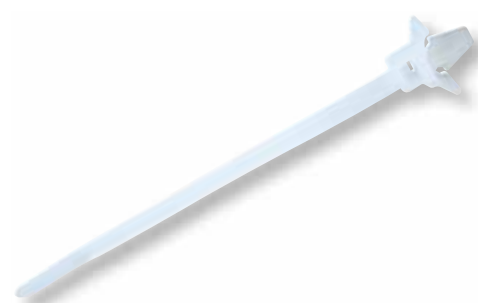

Vysvetlivky piktogramov
C/O

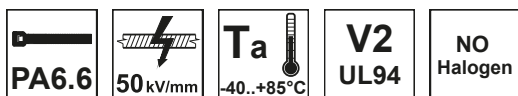
TRACON







Sťahovacie pásky so štítkom

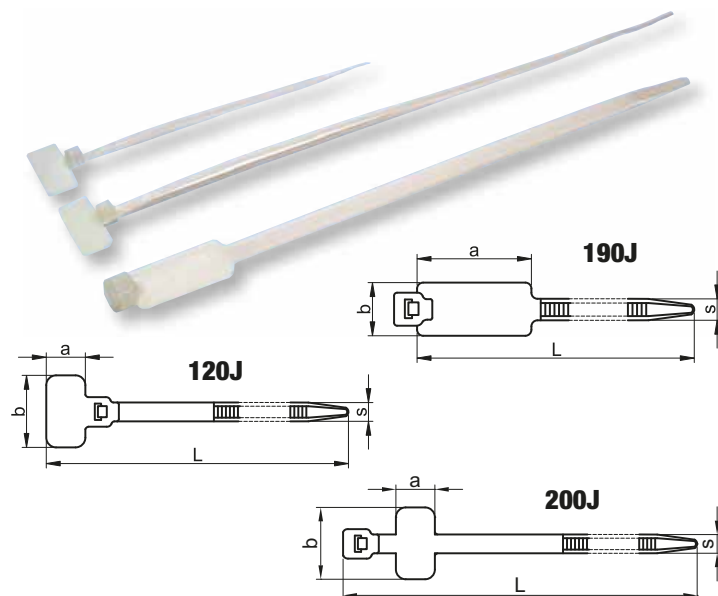

| TRACON | L × S (mm) | a (mm) | b (mm) | | |
|-------------|------------|--------|--------|----------|------|
| 120J | 110 × 2.5 | 8 | 25 | 1-20 mm | 40 N |
| 190J | 190 × 3.6 | 27 | 13 | 10-48 mm | 70 N |
| 200J | 210 × 2.5 | 15 | 30 | 5-45 mm | 40 N |



Oceľové sťahovacie pásky

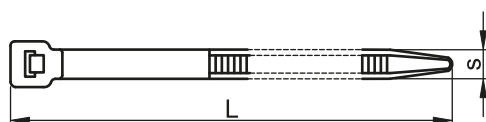

| TRACON | | | |
|-------------|--------------|-------------|-------|
| F125 | 125 × 4.6 mm | 15 - 38 mm | 350 N |
| F200 | 200 × 4.6 mm | 15 - 61 mm | 350 N |
| F201 | 200 × 7.9 mm | 15 - 61 mm | 450 N |
| F290 | 290 × 4.6 mm | 15 - 90 mm | 350 N |
| F291 | 290 × 7.9 mm | 15 - 90 mm | 450 N |
| F520 | 520 × 4.6 mm | 15 - 163 mm | 350 N |
| F521 | 520 × 7.9 mm | 15 - 163 mm | 450 N |
| F840 | 840 × 4.6 mm | 15 - 265 mm | 350 N |
| F841 | 840 × 7.9 mm | 15 - 265 mm | 450 N |



B/18

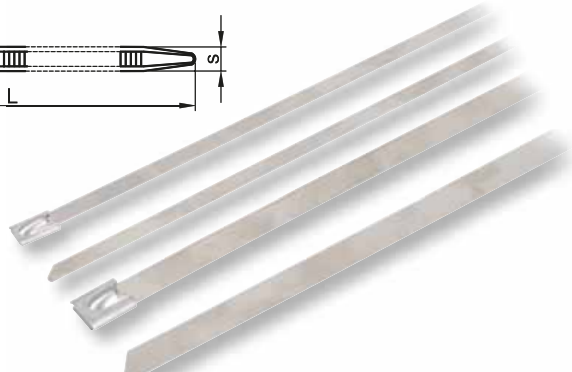
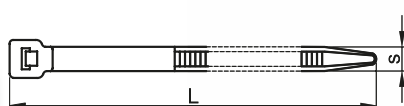

Skrutkovateľná sťahovacia páska

PA6.6
 Ta -40..+85°C
 V2
 UL94

Vysvetlivky piktogramov
C/O

| TRACON | | | | | |
|---------------|--|--------------|------------|-------|------|
| 110-CS | | 110 × 2.5 mm | 3 - 19 mm | 45 N | M2.5 |
| 150-CS | | 150 × 3.6 mm | 3 - 35 mm | 80 N | M4 |
| 160-CS | | 160 × 4.8 mm | 3 - 36 mm | 110 N | M5 |
| 200-CS | | 200 × 4.8 mm | 3 - 49 mm | 110 N | M5 |
| 300-CS | | 300 × 4.8 mm | 3 - 82 mm | 110 N | M5 |
| 310-CS | | 300 × 7.6 mm | 8 - 78 mm | 250 N | M6 |
| 370-CS | | 370 × 4.8 mm | 3 - 103 mm | 110 N | M5 |
| 400-CS | | 400 × 7.6 mm | 8 - 109 mm | 250 N | M6 |

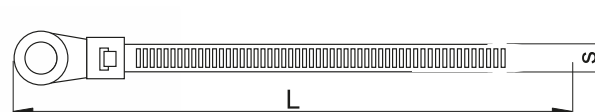

Sťahovacie pásiky so samoupínacou pätkou

PA6.6
 Ta -40..+85°C
 V2
 UL94
 NO Halogen

Vysvetlivky piktogramov
C/O

| TRACON | | | | |
|-------------|--|-------------|-----------|-------|
| CSKT | | 4.8 × 200mm | 3 - 49 mm | 110 N |

Maximálna hrúbka okraja: 3 mm.



Páska na zväzovanie káblov na suchý zips



Vysvetlivky
piktogramov

C/O

| TRACON | | | |
|---------|--|------------------|-------|
| TKR130 | | 130 x 12,5 mm | 35 mm |
| TKR200 | | 200 x 12,5 mm | 35 mm |
| TKR300 | | 300 x 12,5 mm | 89 mm |
| TKR310 | | 300 x 17 mm | 92 mm |
| TKR-12T | | 22,8 m x 12,5 mm | - |
| TKR-20T | | 25 m x 20 mm | - |



TKR-12T
TKR-20T



Samolepiaca príchytka káblov



Vysvetlivky
piktogramov

C/O

| TRACON | | L (mm) | W (mm) | H (mm) |
|--------|--|-----------|-----------|-----------|
| OKT15 | | 15 | 24 | 9 |
| OKT20 | | 20 | 24 | 9 |
| OKT25 | | 25 | 24 | 9 |
| OKT28 | | 28 | 24 | 9 |

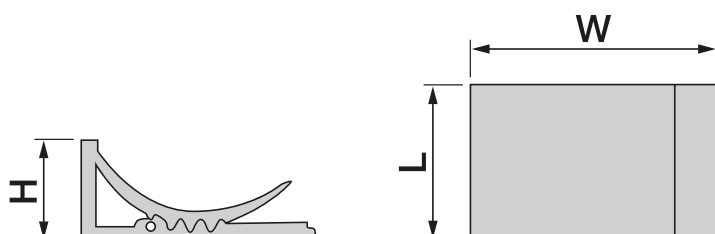

Skrutkovacie pätky k sťahovacím páskam

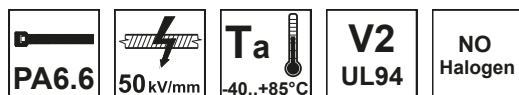

| TRACON | a (mm) | b (mm) | L (mm) | d (mm) | D (mm) |
|----------|--------|--------|--------|--------|--------|
| CSTALP | 15 | 10 | 5.1 | 3.5 | 7 |
| CSTALP-3 | 12.8 | 7 | 4 | 3.3 | 5.8 |
| CSTALP-2 | 23 | 16 | 9 | 6.3 | 9.8 |
| CSTALP-4 | 16 | 11 | 5.3 | 3.5 | 7 |
| CSTALP-5 | 22 | 15 | 8.3 | 5 | 9.5 |
| CSTALP-6 | 26 | 16 | 9.5 | 5 | 10.7 |

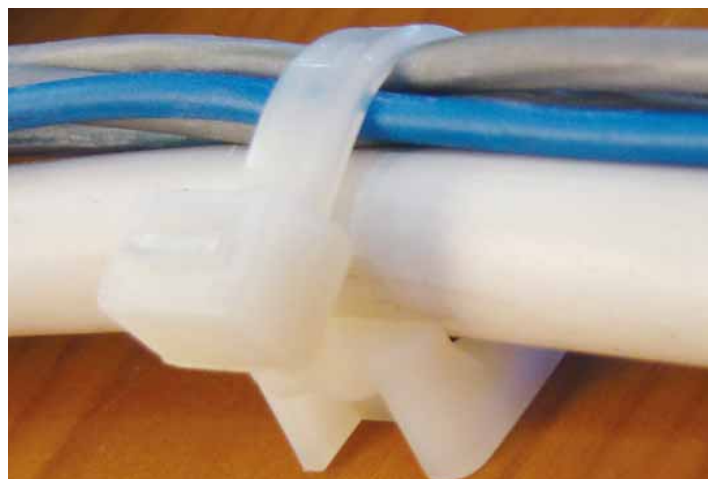
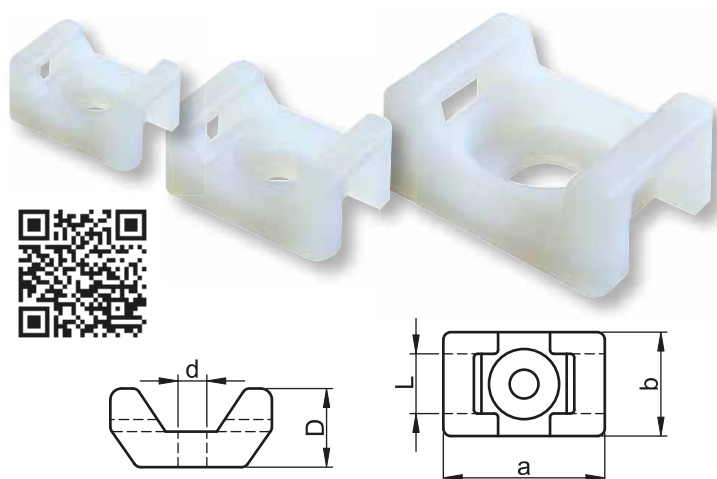

Dvojstupové samolepiace pätky k sťahovacím páskam

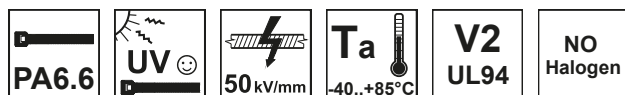

| TRACON | | a (mm) | b (mm) | L (mm) | d (mm) | D (mm) |
|-----------|--|--------|--------|--------|--------|--------|
| TALP190-2 | | 18.7 | 18.7 | 4 | 4.4 | 5.7 |
| TALP191-2 | | 18.7 | 18.7 | 4 | 4.4 | 5.7 |
| TALP270-2 | | 26.5 | 26.5 | 5.8 | 4.3 | 8.1 |
| TALP271-2 | | 26.5 | 26.5 | 5.8 | 4.3 | 8.1 |

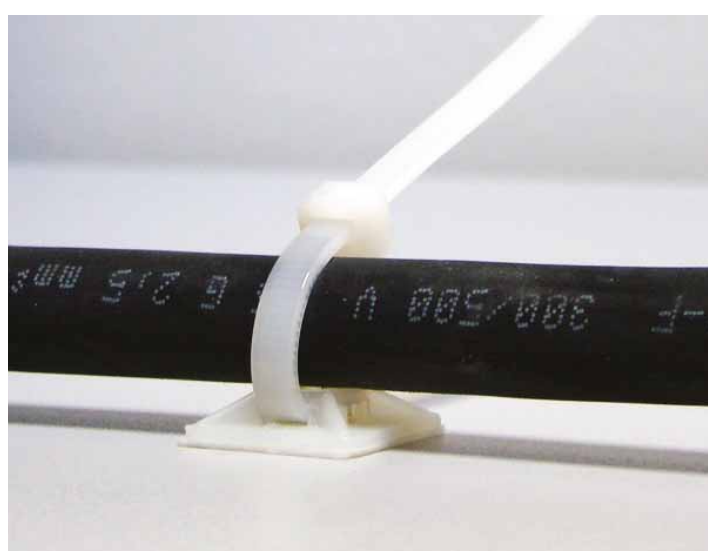
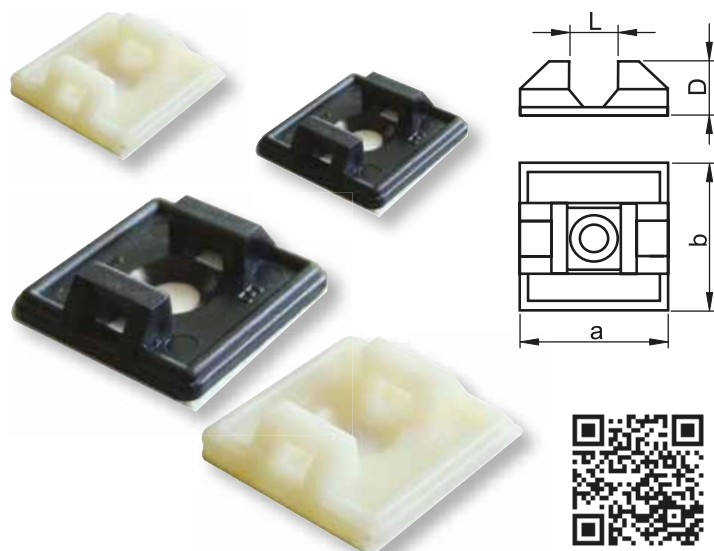

Štvorstupové samolepiace pätky k sťahovacím páskam

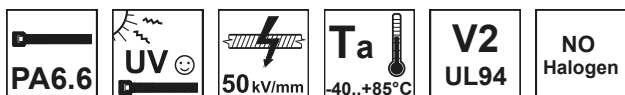

| TRACON | | a (mm) | b (mm) | L (mm) | d (mm) | D (mm) |
|---------|--|--------|--------|--------|--------|--------|
| TALP190 | | 20 | 20 | 5 | 2.9 | 6.1 |
| TALP191 | | 20 | 20 | 5 | 2.9 | 6.1 |
| TALP200 | | 19 | 19 | 4.3 | 5 | 6 |
| TALP201 | | 19 | 19 | 4.3 | 5.7 | 6.5 |
| TALP270 | | 25 | 25 | 6.2 | 3.5 | 7.5 |
| TALP271 | | 25 | 25 | 6.2 | 3.5 | 7.5 |
| TALP280 | | 28 | 28 | 5.2 | 5.7 | 6.5 |
| TALP281 | | 28 | 28 | 5.2 | 5.7 | 6.5 |

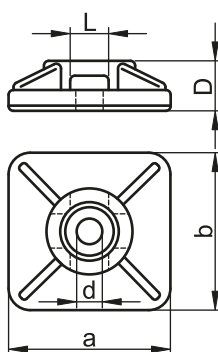

Ztláčacie hmoždinky k sťahovacím páskam

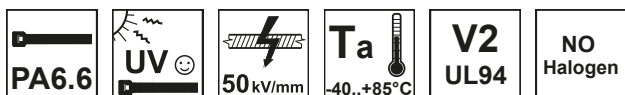

| TRACON | | | a (mm) | b (mm) | c (mm) | W ₁ (mm) | W ₂ (mm) | L (mm) | D (mm) |
|--------|--|------|--------|--------|--------|---------------------|---------------------|--------|--------|
| 5458 | | 8 mm | 10.6 | 6.3 | 3.1 | 12.8 | 12.6 | 43.8 | 9.9 |
| 5458N | | 7 mm | 9.8 | 6.4 | 2.1 | 15.4 | 11.1 | 38.0 | 7.9 |
| 8138 | | 7 mm | 10.2 | 6.4 | 3 | 14.6 | 11 | 38 | 9.9 |
| 9843 | | 8 mm | 10.3 | 6.5 | 3.2 | 12.8 | 12.9 | 43.3 | 9.7 |

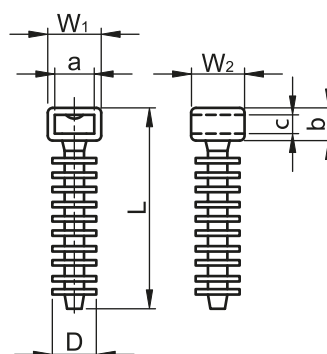
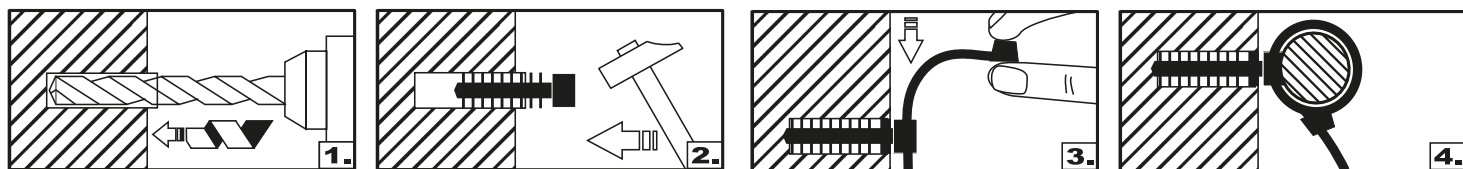

Príchytky na káble, s klincom

| TRACON | |  | a (mm) | b (mm) |
|---------|--------|---|--------|--------|
| 100 pcs | 20 pcs | | | |
| NOF | NOF-20 | | 2.5 | 4.5 |
| N1 | N1-20 | | 6 | 7.3 |
| N2 | N2-20 | | 8 | 8.1 |
| N3 | N3-20 | | 9 | 8.3 |
| N4 | N4-20 | | 11 | 10 |

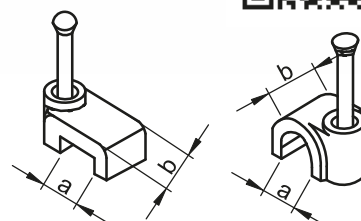

Samoupínacie príchytky



| TRACON |  | D (mm) | W (mm) | L (mm) | H (mm) |
|--------|--|--------|--------|--------|--------|
| CSS-16 | | 16 | 29.3 | 12.9 | 21.7 |
| CSS-20 | | 20 | 33 | 12.9 | 24.2 |
| CSS-25 | | 25 | 37.5 | 12.9 | 27.9 |

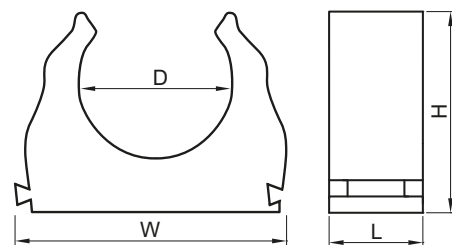

Samolepiace klipsy



| TRACON |  | d (mm) | W (mm) | L (mm) |
|-----------|---|--------|--------|--------|
| TKCR-0708 | | 7-8 | 20 | 25 |

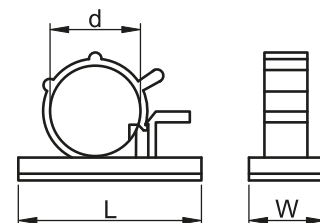

Rozpínacie káblvé príchytky

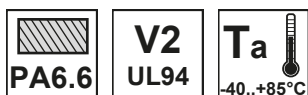

| TRACON | | d (mm) | L (mm) | H (mm) |
|----------|--|--------|--------|--------|
| TKCRZ-12 | | 12 | 28 | 24.5 |
| TKCRZ-15 | | 15 | 28 | 28.5 |
| TKCRZ-18 | | 18 | 28 | 33 |
| TKCRZ-22 | | 22 | 34 | 37 |
| TKCRZ-28 | | 28 | 38,5 | 45 |
| TKCRZ-32 | | 32 | 38 | 47.5 |
| TKCRZ-35 | | 35 | 41 | 49 |



Umelohmotné káblvé príchytky

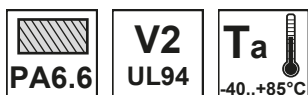

| TRACON | | a (mm) | b (mm) | L (mm) | l (mm) | H (mm) | W (mm) |
|--------|--|--------|--------|--------|--------|-----------|--------|
| BCSV-3 | | 10-18 | 18.6 | 26.4 | 16.2 | 19.8-37.5 | 17.7 |
| BCSV-4 | | 19-31 | 28.8 | 39.4 | 15.1 | 39.5-51.6 | 18.2 |

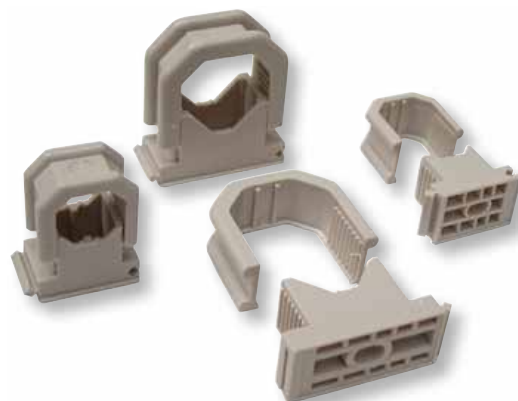
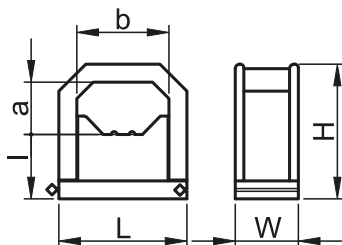

Hmoždinky na uchytenie káblov

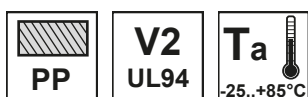

| TRACON | | d ₁ (mm) | d ₂ (mm) | B (mm) | L (mm) |
|--------|--|---------------------|---------------------|--------|--------|
| KRT | | 6 | 6 | 10 | 36.5 |
| KRT8 | | 8 | 7.7 | 12.2 | 42.7 |

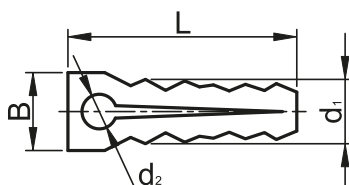

Hmoždinky s profilovými skrutkami

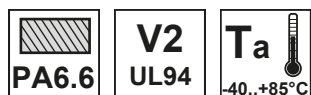

| TRACON | | D × L (mm) | d (mm) | l ₁ (mm) | l ₂ (mm) | B (mm) |
|--------|--|------------|--------|---------------------|---------------------|--------|
| T6H | | 6 × 30 | 3.3 | 37 | 24.2 | 15.4 |
| T6K | | 6 × 30 | 3.3 | 38.5 | 10 | 13.4 |

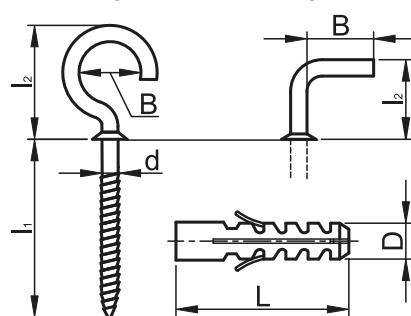

Hmoždinky lemované, so šesťhrannou skrutkou

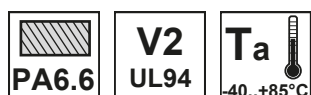

| TRACON | D × L (mm) | d × l (mm) |
|---------|------------|------------|
| | | |
| T10080P | 10 × 80 | 6.8 × 95 |
| T10100P | 10 × 100 | 6.8 × 115 |
| T10120P | 10 × 120 | 6.8 × 135 |
| T10140P | 10 × 140 | 6.8 × 155 |
| T10160P | 10 × 160 | 6.8 × 175 |
| T10200P | 10 × 200 | 6.8 × 215 |
| T10240P | 10 × 240 | 6.8 × 255 |
| T10300P | 10 × 300 | 6.8 × 315 |

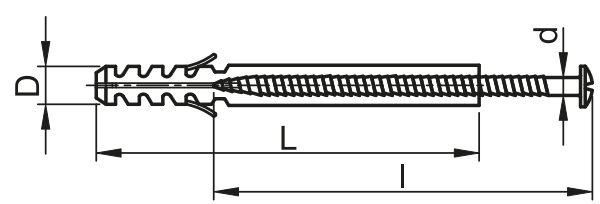

Zatíkové hmoždinky ddo sadrokartónu

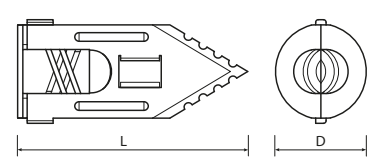

| TRACON | D × L (mm) | |
|--------|------------|----------|
| GTL30 | 10,5 × 30 | 3,5-4 mm |
| GTL40 | 10,5 × 40 | 3,5-4 mm |
| GTL43 | 16 × 43 | 3,5-4 mm |



Hmoždinky s vysokou zaťažiteľnosťou

V2
UL94Ta
-40..+85°CVysvetlivky
piktogramov

C/O

| TRACON | D × L (mm) | d × l (mm)* |
|---------|---------------|----------------|
| T5-UNI | 5 × 25 | 3.5 × 35 |
| T6-UNI | 6 × 30 | 4 × 40 |
| T8-UNI | 8 × 40 | 5 × 50 |
| T10-UNI | 10 × 50 | 6 × 60 |

* Rozmery odporúčanej skrutky

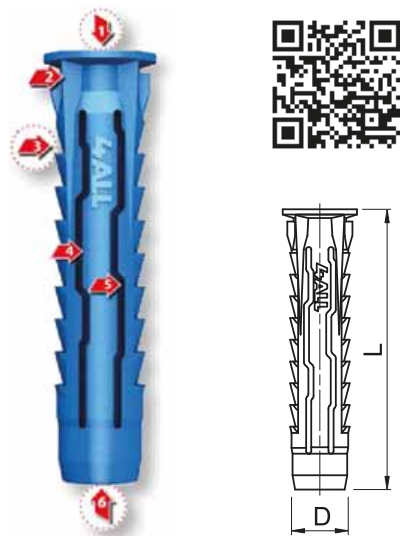

Jedinečné vyhotovenie vnútra, s vynikajúcim uložením použitej skrutky.



Kriedelka proti otočeniu, ktoré fixujú hmoždin-ku v každom type muriva, ako aj v mäkkých materiáloch.



Ryhovanie pod hlavou zvyšuje bezpečné zafixovanie hmoždinky v každom materiáli.



Hmoždinka sa doťahovaním skrutky skracuje a plášť sa v dutých materiáloch rozširuje, čo umožňuje vynikajúce fixovanie.

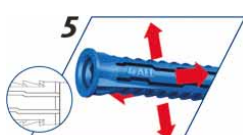

Rozširovanie do 4 strán umožňuje použiteľnosť v murive ľubovoľného typu a materiálu.



Zosilnený hrot hmoždinky zabezpečuje vhodné vedenie skrutky pri montáži.



Betón



Duté murivo



Stavebná doska

Hmoždinky do sadrokartónu

V2
UL94Ta
-40..+85°C

| TRACON | Popis | D × L (mm) | d × l (mm)* |
|--------|---|---------------|----------------|
| GBT | Hmoždinka skrutkovacia do sadrokartónu | 16 × 36 | 4 × 35 |
| GSZT | Hmoždinka s kriedelkami do sadrokartónu | 10 × 55 | 4 × 50 |

* Rozmery odporúčanej skrutky

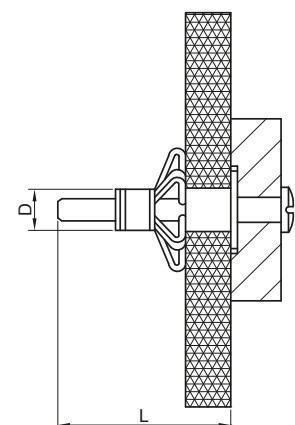

GSZT

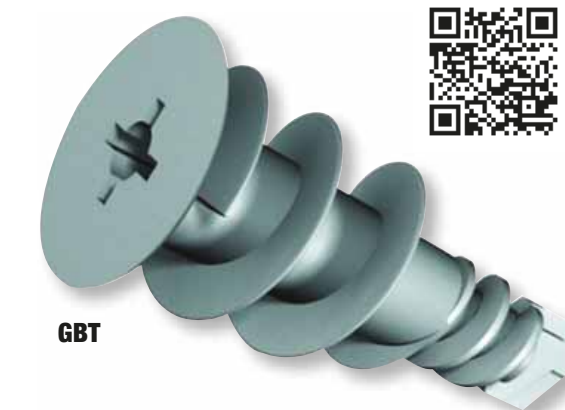

GBT



Hmoždinky štvorhranné



V2
UL94

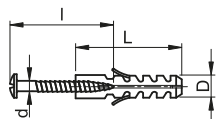

| TRACON | | D × L (mm) | d × l (mm) |
|-------------|---------------|---------------|---------------|
| | | | |
| TN6 | TNCS6 | 6 × 23 | 2.6 × 30 |
| TN8 | TNCS8 | 8 × 34 | 3.5 × 38 |
| TN10 | TNCS10 | 10 × 42 | 4.4 × 46 |
| TN12 | TNCS12 | 12 × 52 | 5.4 × 61 |
| TN14 | - | 14 × 65 | - |



Vysvetlivky piktogramov **C/O**

Hmoždinky so zatĺkacou skrutkou



V2
UL94

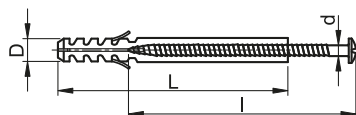

| TRACON | | | TRACON | | |
|--------------|---------------|---------------|---------------|---------------|---------------|
| | D × L (mm) | d × l (mm) | | D × L (mm) | d × l (mm) |
| TB525 | 5 × 25 | 3.5 × 29 | TB845 | 8 × 45 | 4.9 × 48 |
| TB535 | 5 × 30 | 3.5 × 38 | TB860 | 8 × 60 | 4.4 × 60 |
| TB545 | 5 × 50 | 3.5 × 47 | TB875 | 8 × 80 | 4.7 × 78 |
| TB635 | 6 × 35 | 3.7 × 39 | TB8100 | 8 × 100 | 4.7 × 102 |
| TB645 | 6 × 40 | 3.7 × 48 | TB8120 | 8 × 120 | 4.4 × 122 |
| TB655 | 6 × 55 | 3.7 × 58 | TB8135 | 8 × 135 | 4.4 × 137 |
| TB670 | 6 × 80 | 3.2 × 83 | | | |



Hmoždinky dlhé, PA6.6



V2
UL94

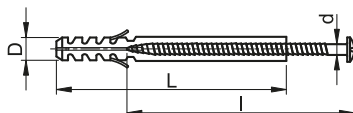

| TRACON | | D × L (mm) | d × l (mm) |
|----------------|-----------------|---------------|---------------|
| | | | |
| - | THC8100 | 8 × 100 | 5.3 × 104 |
| TH8120 | THC8120 | 8 × 120 | 5.5 × 126 |
| TH8135 | THC8135 | 8 × 135 | 5.4 × 134 |
| TH1080 | THC1080 | 10 × 80 | 6.8 × 85 |
| TH10100 | THC10100 | 10 × 100 | 6.8 × 105 |
| TH10115 | THC10115 | 10 × 115 | 6.8 × 119 |
| TH10135 | THC10135 | 10 × 135 | 6.8 × 141 |
| TH10160 | THC10160 | 10 × 160 | 7 × 165 |



Hmoždinky klasické



V2
UL94

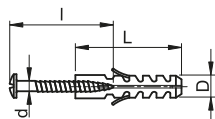

| TRACON | | D × L (mm) | d × l (mm) |
|--------|---|---------------|---------------|
| | | 6 × 30 | 4 × 40 |
| | | 8 × 40 | 5 × 50 |
| | | 10 × 50 | 5.5 × 60 |
| | - | 12 × 60 | - |
| | - | 14 × 75 | - |

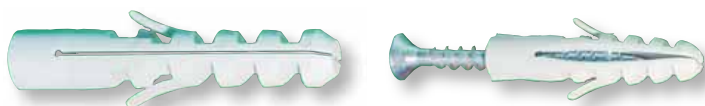

Vysvetlivky piktogramov **C/O**

Hmoždinky lemované



V2
UL94

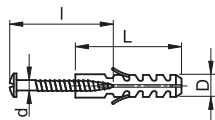

| TRACON | | D × L (mm) | d × l (mm) |
|--------|---|---------------|---------------|
| - | | 6 × 30 | 4 × 40 |
| | | 8 × 40 | 5 × 50 |
| | | 10 × 50 | 5.5 × 60 |
| | - | 12 × 60 | - |



Hmoždinky uzlovacie



V2
UL94

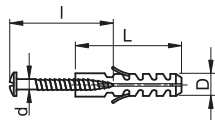

| TRACON | | D × L (mm) | d × l (mm) |
|--------|--|---------------|---------------|
| | | 6 × 40 | 4 × 50 |
| | | 8 × 50 | 5 × 60 |
| | | 10 × 60 | 6 × 70 |



NAČÍTAJTE KÓD!

- Pozrite si naše novinky!
- Buďte informovaný!

Náš sortiment sa neustále a rýchlo rozrastá.
Predložený katalóg odráža stav k aprílu 2021.
Pre aktuálne informácie, prosím,
navštívte našu internetovú stránku!

Sklápacie závesy do dutých priestorov



TMK TMCS TMM TMSZ

| TRACON | d (mm) | L (mm) | a (mm) | B (mm) | |
|--------|--------|--------|--------|--------|-------|
| TMK | M4 | 95 | 20 | 14 | 200 N |
| TMCS | M4 | 81 | 20 | – | 800 N |
| TMM | M4 | 100 | 20 | – | 800 N |
| TMSZ | M4 | 93 | 20 | 14 | 200 N |

Materiál: oceľ, pozinkovaná.

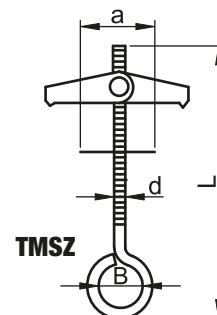
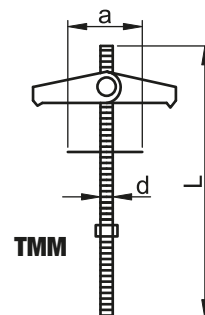
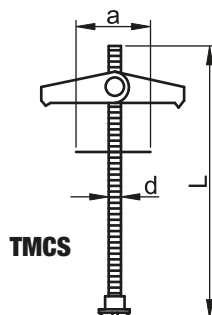
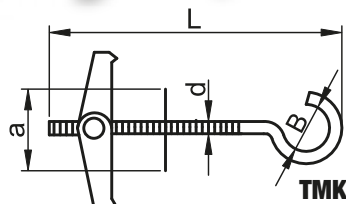

Lanové očnice

| TRACON | W (mm) | I (mm) | L (mm) | c (mm) | s (mm) | |
|---------|--------|--------|--------|--------|--------|------------|
| SZIV-3 | 4.5 | 41.6 | 46.3 | 17 | 1 | 1 – 3 mm |
| SZIV-4 | 5.5 | 37.7 | 41.7 | 15 | 1 | 3 – 4 mm |
| SZIV-5 | 6.2 | 37.8 | 42.4 | 15 | 1 | 4 – 5 mm |
| SZIV-6 | 9 | 42.8 | 47.5 | 18.1 | 1 | 5 – 6 mm |
| SZIV-8 | 9.4 | 47.7 | 54.5 | 19.2 | 1.5 | 6 – 7 mm |
| SZIV-10 | 12.1 | 53.8 | 59.7 | 21.9 | 1.5 | 7 – 9 mm |
| SZIV-12 | 17.1 | 62.4 | 68.5 | 28.8 | 1.5 | 9 – 12 mm |
| SZIV-16 | 21.1 | 75.7 | 82.9 | 39.2 | 2 | 12 – 14 mm |
| SZIV-19 | 21.6 | 80.6 | 90.3 | 42.2 | 2.3 | 16 – 19 mm |

Materiál: oceľ, pozinkovaná.

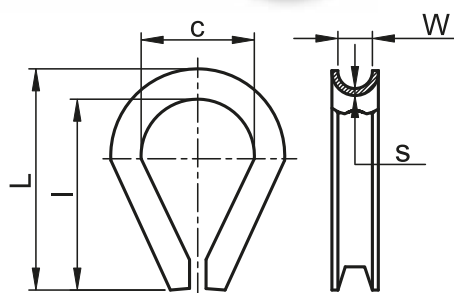

Háky "S"

| TRACON | d (mm) | L (mm) | l (mm) | m (mm) | D (mm) |  |
|---------|--------|--------|--------|--------|--------|---|
| HR3-25 | 3 | 26 | 20.2 | 3 | 7 | 320 N |
| HR3-30 | 3 | 31.1 | 25.5 | 4.8 | 8.8 | 320 N |
| HR4-30 | 4 | 33.4 | 25.5 | 4.8 | 10 | 575 N |
| HR4-35 | 4 | 35.3 | 27.5 | 5.2 | 10.2 | 575 N |
| HR4-40 | 4 | 41 | 33.3 | 5.9 | 10.9 | 575 N |
| HR5-45 | 4.8 | 46 | 36.7 | 6.6 | 12.5 | 730 N |
| HR5-50 | 5 | 53.5 | 44 | 10.3 | 15.3 | 885 N |
| HR6-80 | 6 | 80 | 69 | 12 | 24 | 1250 N |
| HR8-100 | 8 | 104 | 88 | 17 | 31 | 2000 N |

Materiál: oceľ, pozinkovaná.



Lanové svorky, profil "U"

| TRACON | d (mm) | D (mm) | W (mm) | H (mm) | h (mm) | L (mm) |  mm |
|--------|--------|--------|--------|--------|--------|--------|--|
| U03 | M4 | 5.4 | 9.5 | 20.4 | 7.3 | 18 | 2-3 mm |
| U05 | M5 | 7.2 | 9.6 | 24.2 | 7.5 | 21.5 | 3.2-5 mm |
| U06 | M5 | 8.0 | 11.2 | 24.2 | 9.5 | 23.8 | 4.5-7 mm |
| U08 | M6 | 9 | 12.9 | 35.4 | 10.4 | 27.4 | 6.3-8 mm |
| U09 | M8 | 10.5 | 16.6 | 37.3 | 12.7 | 33 | 8-9 mm |
| U11 | M8 | 11 | 18.4 | 41 | 16 | 36.4 | 10-11 mm |
| U13 | M10 | 14.8 | 20.6 | 54.7 | 18.7 | 42.2 | 12-14 mm |
| U14 | M10 | 14.9 | 24.2 | 55.2 | 23 | 43.7 | 12-14 mm |
| U16 | M10 | 18.2 | 26 | 62 | 25.2 | 49.9 | 14-16 mm |
| U19 | M12 | 21.5 | 29.7 | 76.8 | 30.2 | 54.4 | 16-19 mm |
| U22 | M12 | 21.5 | 31 | 77.8 | 33.2 | 56.7 | 19-22 mm |
| U25 | M14 | 27.7 | 32.8 | 95.7 | 34.5 | 63.3 | 22-25 mm |

Materiál: napínacia skrutka: oceľ, pozinkovaná. Telo svorky: temperovaná zliatina.

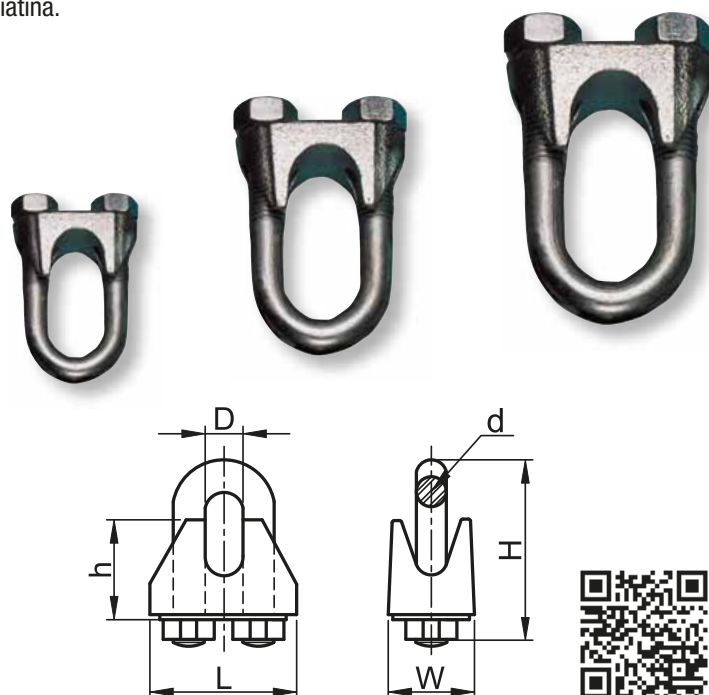

Lanové svorky jednoskrutkové “simplex”

| TRACON | d (mm) | b (mm) | B (mm) | H (mm) | L (mm) | k (mm) |
|--------|-----------|-----------|-----------|-----------|-----------|-----------|
| BSZ1-2 | M4 | 5.1 | 13.6 | 6.1 | 17.2 | 13 |
| BSZ1-3 | M4 | 6.4 | 15.3 | 7 | 18.4 | 13.6 |
| BSZ1-4 | M5 | 10 | 16.6 | 6.5 | 21 | 17.4 |
| BSZ1-5 | M5 | 10.4 | 18.7 | 8.9 | 24.4 | 16.9 |
| BSZ1-6 | M6 | 12.5 | 23.3 | 9.6 | 30.2 | 21.6 |
| BSZ1-8 | M8 | 18.6 | 30.4 | 13.5 | 36.5 | 29.2 |

Materiál: oceľ, pozinkovaná.

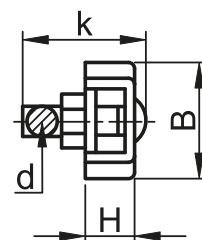
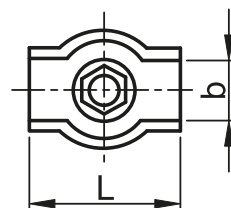
Lanové svorky dvojskrutkové “duplex”

| TRACON | d (mm) | b (mm) | B (mm) | H (mm) | L (mm) | k (mm) |
|--------|-----------|-----------|-----------|-----------|-----------|-----------|
| BSZ2-2 | M4 | 5.8 | 12.9 | 5 | 36.6 | 13.4 |
| BSZ2-3 | M4 | 6.4 | 15.3 | 6.7 | 35.2 | 13.5 |
| BSZ2-4 | M5 | 8.4 | 17.5 | 7.1 | 40 | 17.6 |
| BSZ2-5 | M5 | 11.9 | 20.4 | 8.8 | 48.8 | 19.6 |
| BSZ2-6 | M6 | 12.5 | 23.3 | 9.6 | 60.5 | 21.6 |
| BSZ2-8 | M8 | 18.6 | 30.4 | 13.5 | 73 | 29.2 |

Materiál: oceľ, pozinkovaná.

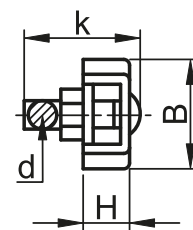
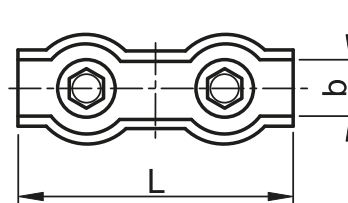

Lanové svorky ploché “AMAX”

| TRACON | d (mm) | W (mm) | H (mm) | L (mm) | k (mm) |  |
|--------|-----------|-----------|-----------|-----------|-----------|---|
| AMAX3 | M3 | 16.1 | 10.2 | 28.6 | 12.7 | 3 mm (1/8") |
| AMAX5 | M5 | 17.5 | 10.7 | 30.5 | 12.4 | 5 mm (3/16") |
| AMAX6 | M6 | 22.9 | 12.9 | 34.9 | 15.9 | 6 mm (1/4") |

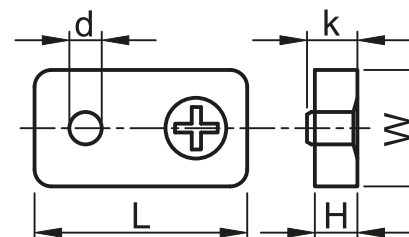
Materiál: oceľ, pozinkovaná.



Karabíny s pružinou

| TRACON | d (mm) | D (mm) | W (mm) | L (mm) | m (mm) |  |
|---------|-----------|-----------|-----------|-----------|-----------|---|
| RKARA4 | 4.5 | 5.8 | 21.1 | 42.0 | 5.5 | 300 N |
| RKARA5 | 5 | 6.6 | 26 | 51.3 | 7.2 | 500 N |
| RKARA6 | 6 | 6.9 | 30.2 | 62.3 | 7.7 | 800 N |
| RKARA7 | 7 | 7.8 | 35.1 | 70.7 | 8.7 | 1100 N |
| RKARA8 | 8 | 8.1 | 40.4 | 80.5 | 10.2 | 1400 N |
| RKARA9 | 9 | 9.7 | 45 | 90.3 | 11.7 | 1700 N |
| RKARA10 | 10 | 11.1 | 47.3 | 99.8 | 13.4 | 2100 N |
| RKARA11 | 11 | 12.3 | 57.3 | 121.2 | 16.5 | 2500 N |
| RKARA12 | 12 | 13.9 | 63.2 | 142.5 | 20.8 | 2700 N |
| RKARA13 | 13 | 15.8 | 72.8 | 149.4 | 24.1 | 3000 N |

Materiál: oceľ, pozinkovaná.

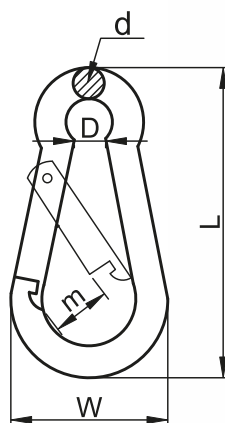

Karabíny so skrutkou

| TRACON | d (mm) | D (mm) | W (mm) | L (mm) |  |
|-----------|-----------|-----------|-----------|-----------|---|
| CSKARA3,5 | 3.5 | 10.8 | 17.9 | 35.5 | 420 N |
| CSKARA4 | 4 | 11.6 | 19.7 | 40.6 | 850 N |
| CSKARA5 | 5 | 13.6 | 23.5 | 50.9 | 1270 N |
| CSKARA6 | 6 | 14.7 | 26.7 | 58.3 | 1700 N |
| CSKARA7 | 7 | 18.4 | 32 | 68.2 | 2550 N |
| CSKARA8 | 8 | 19.6 | 36 | 73.8 | 3100 N |
| CSKARA9 | 9 | 20.6 | 39.2 | 82.2 | 4250 N |
| CSKARA10 | 10 | 21.6 | 42.4 | 89.6 | 5100 N |
| CSKARA12 | 12 | 23.5 | 48.3 | 106.2 | 6400 N |

Materiál: oceľ, pozinkovaná.

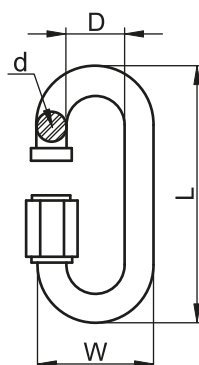

Napínacie skrutky

| TRACON | | | d (mm) | l (mm) | L (mm) | d (mm) | |
|--------|--|---|-----------|-----------|-----------|-----------|--------|
| | | | 5 | 50 | 92.6 | 7.8 | 750 N |
| | | | 5 | 70 | 113 | 8 | 770 N |
| | | | 6 | 60 | 112 | 10 | 1050 N |
| | | | 6 | 100 | 154 | 10.2 | 1800 N |
| | | - | 8 | 70 | 137 | 12.3 | 1200 N |
| | | | 8 | 110 | 176 | 12.3 | 2000 N |
| | | | 10 | 120 | 194 | 13.3 | 3000 N |
| | | | 12 | 130 | 224 | 18.3 | 4450 N |
| - | | | 16 | 140 | 265 | 22 | 5950 N |

Skrutka: oceľ, pozinkovaná. Telo: temperovaná zliatina.



FSS



FSH



FHH

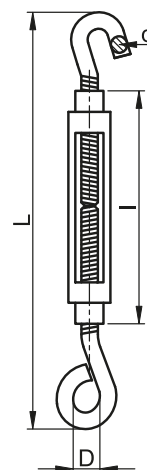

Káblové zväzovacie špirály

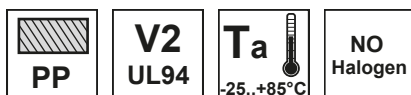

| TRACON | d (mm) | D (mm) | s (mm) | | |
|--------|-----------|-----------|-----------|-----|-------|
| | 6.2 | 8.6 | 1.9 | 1 m | 6 mm |
| | 8 | 10.9 | 2.4 | 1 m | 8 mm |
| | 10 | 13.2 | 2.9 | 1 m | 10 mm |
| | 12 | 15.4 | 2.9 | 1 m | 12 mm |
| | 15 | 17.1 | 2.9 | 1 m | 15 mm |
| | 20 | 24 | 3 | 1 m | 20 mm |
| | 25 | 28.7 | 3 | 1 m | 25 mm |

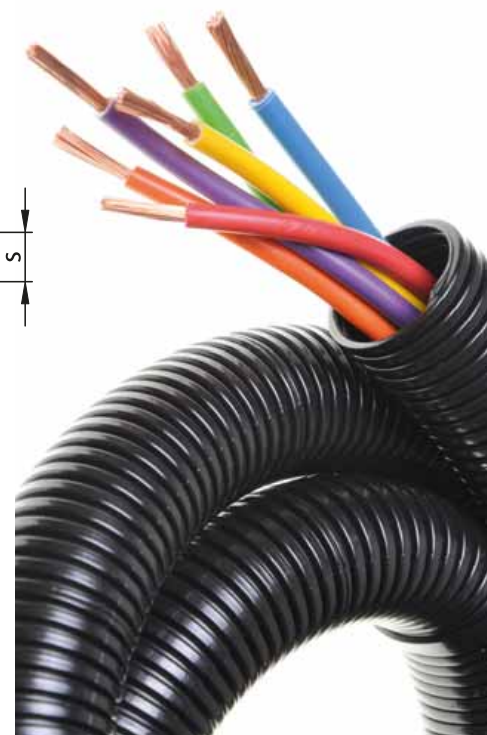
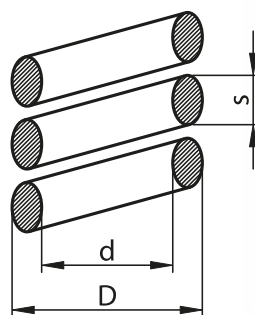

NAČITAJTE KÓD!

- Pozrite si naše novinky!
- Buďte informovaný!

Náš sortiment sa neustále a rýchlo rozrastá. Predložený katalóg odráža stav k aprílu 2021.

Pre aktuálne informácie, prosím, navštívte našu internetovú stránku!

Káblové zväzovacie špirály

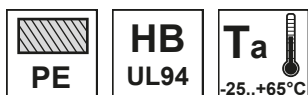

| TRACON | | D (mm) | d (mm) | W (mm) | | |
|-----------------|-----------------|-----------|-----------|-----------|------|-------------|
| KSPI-4N | KSPI-4F | 4.5 | 3.2 | 6.8 | 10 m | 4...20 mm |
| KSPI-6N | KSPI-6F | 6.9 | 5.3 | 10.3 | 10 m | 7...40 mm |
| KSPI-8N | KSPI-8F | 8.4 | 6.6 | 11.7 | 10 m | 12...50 mm |
| KSPI-10N | KSPI-10F | 10.2 | 8.2 | 13.4 | 10 m | 13...70 mm |
| KSPI-12N | KSPI-12F | 12.2 | 9.6 | 15.9 | 10 m | 15...80 mm |
| KSPI-16N | KSPI-16F | 15.7 | 12.4 | 21.6 | 10 m | 20...120 mm |

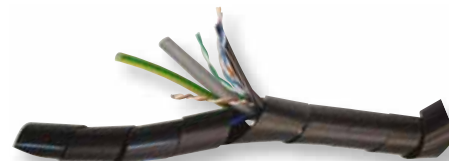
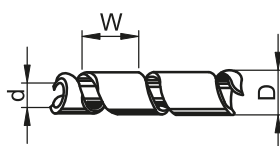

Plastové zväzovacie sieťky

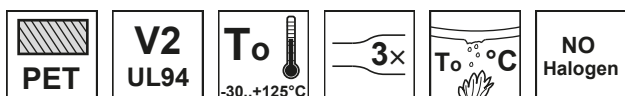

| TRACON | | |
|----------------|-------|----------------|
| TKH-003 | 3 mm | 2.4 – 6.4 mm |
| TKH-010 | 10 mm | 4.8 – 15.9 mm |
| TKH-016 | 16 mm | 9.5 – 25.4 mm |
| TKH-025 | 25 mm | 15.9 – 36.1 mm |
| TKH-032 | 32 mm | 19.1 – 44.5 mm |



Umožňujú flexibilné uloženie a mechanickú ochranu káblov a vodičov v slaboj- i silnoprúdových elektrických inštaláciách, v automobilovom priemysle. Rezanie na príslušnú dĺžku je účelné vykonávať horúcim nožom alebo špeciálnym spájkovacím hrotom. Otvorený systém zväzovania umožňuje dobrú ventiláciu a odvedenie tepla od povrchu vodičov.

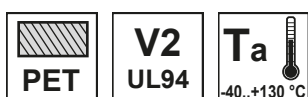

Pletená zväzovacia sieťka

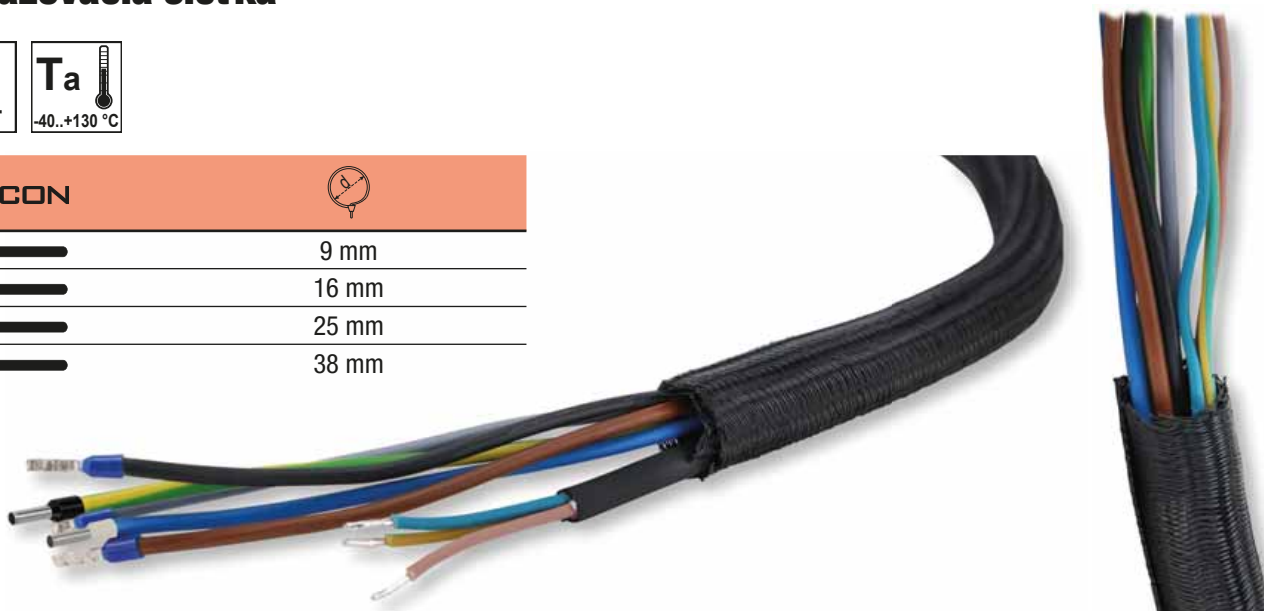

| TRACON | |
|--------------|-------|
| OFK9 | 9 mm |
| OFK16 | 16 mm |
| OFK25 | 25 mm |
| OFK38 | 38 mm |



Plomba

| TRACON |  | L (mm) | a (mm) | b (mm) |  |
|--------|---|--------|--------|--------|---|
| JPL1 | | 230 | 18 | 54 | 80 N |
| JPL2 | | 330 | 18 | 54 | 80 N |
| JPL3 | | 415 | 21 | 79 | 200 N |



Výrobok na označovanie, ktorá obsahuje jedinečné sériové číslo, čím sa ľahko dajú identifikovať chránené predmety. Nasadenie a odstránenie plomby je jednoduché, nepotrebujeme žiadne náradie. Hlavice umelohmotných plomb sú vyrobené z kovu ,alebo z tvrdej umelej hmoty, ktorá nereaguje na teplo. Nedajú sa odstrániť bez zničenia.



Plomba na meracie prístroje

| TRACON |  | a (mm) | b (mm) |
|--------|---|--------|--------|
| MP1 | | 30,5 | 21 |
| MP2 | | 27 | 13 |

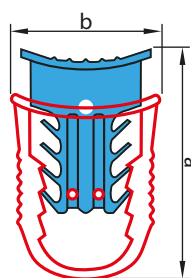

Plomby na meracie prístroje sú vhodné na symbolickú ochranu rozvodných skríň, plynových hodín a iných meracích hodín. Ponúkame na všetky také miesta, kde potrebujete symbolicky uzavrieť, ale nechcete aby plomba pred časom sa roztrhla. Na nasadenie nepotrebujete žiadne náradie ani pomocný materiál.

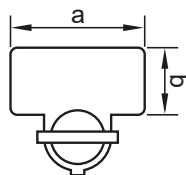

NAČÍTAJTE KÓD!

- Pozrite si naše novinky!
- Buďte informovaný!

Náš sortiment sa neustále a rýchlo rozrastá. Predložený katalóg odráža stav k aprílu 2021.

Pre aktuálne informácie, prosím, navštívte našu internetovú stránku!

TRACON
.....ELECTRIC®

EVO

MODULÁRNE PRÍSTROJE



F/14-F/28