

Pictograms of the table head

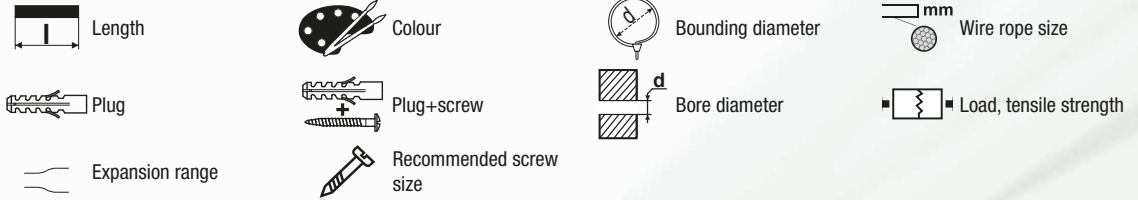

Pictograms of the technical data

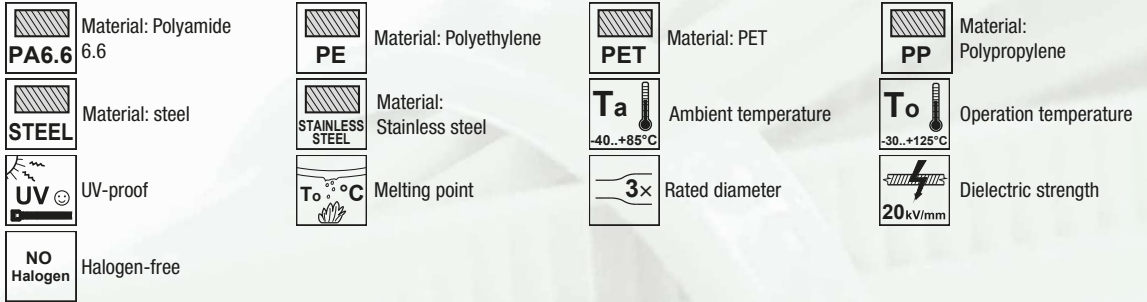

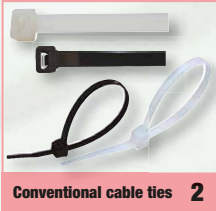

Conventional cable ties **2**

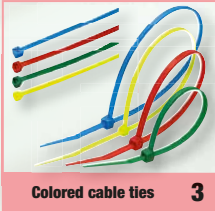

Colored cable ties **3**

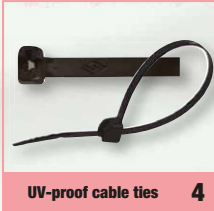

UV-proof cable ties **4**

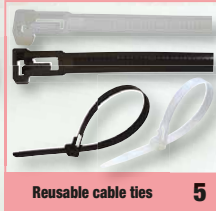

Reusable cable ties **5**



Reusable cable ties with pearls **5**

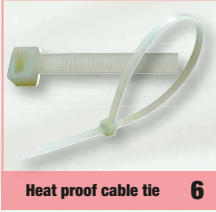

Heat proof cable tie **6**



Cable tie with flame retardant **6**

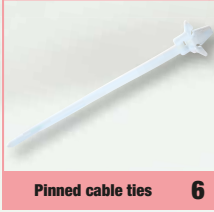

Pinned cable ties **6**

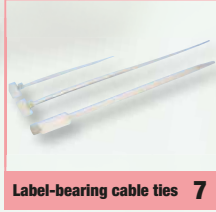

Label-bearing cable ties **7**



Steel cable tie **7**



Edge clip cable tie **8**



Velcro cable organizer **9**



Self-adhesive cable holder **9**

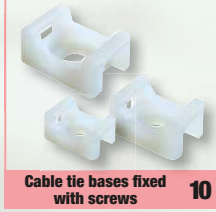

Cable tie bases fixed with screws **10**



Cable tie fixing plugs **11**



Plastic cable/wire clamps with pin **12**



Plastic pipe clip **12**



Wire fixing plug **13**



Hammer-in fixing for drywalls **14**



Plug for drywall **14**



Plug with neck and hexagonal flanged screw **15**



Extremely resistant Nylon plugs, for all building materials **15**



Collar plug **16**



Knock-in plug **17**



Stainless steel dowels **18**



Threaded rod and accessories **19**



Wire thimble **20**



Hook **21**



U wire clips **21**



Double wire clips **22**



Spring hooks **23**



Turnbuckles **23**



Long grain chain **24**



Cable tie spiral **25**



Self-locking woven cable stockings **25**

Conventional cable ties

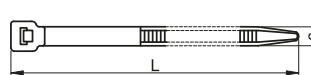

TRACON						
80PR		81PR		75 × 2.2 mm	0.75-15 mm	35 N
120PR		121PR		98 × 2.5 mm	1-21 mm	45 N
130PR		131PR		135 × 2.6 mm	1-32 mm	45 N
150PR		151PR		140 × 3.6 mm	2-36 mm	80 N
160PR		161PR		160 × 2.6 mm	1-40 mm	45 N
170PR		171PR		200 × 3.6 mm	2-50 mm	80 N
180PR		181PR		180 × 7.8 mm	3.5-45 mm	250 N
190PR		191PR		200 × 4.8 mm	3-50 mm	110 N
200PR		201PR		200 × 2.6 mm	1-52 mm	45 N
210PR		211PR		290 × 4.8 mm	3.5-79 mm	110 N
220PR		221PR		360 × 4.8 mm	3.5-103 mm	110 N
230PR		231PR		290 × 3.6 mm	2-80 mm	80 N
250PR		251PR		250 × 4.8 mm	3-68 mm	110 N
260PR		261PR		365 × 7.8 mm	8-100 mm	250 N
270PR		271PR		260 × 2.5 mm	3-73 mm	45 N
280PR		281PR		280 × 8.0 mm	4-65 mm	180 N
300PR		301PR		300 × 7.8 mm	5-80 mm	250 N
370PR		371PR		370 × 3.6 mm	5-108 mm	80 N
430PR		431PR		430 × 4.8 mm	3.5-115 mm	110 N
450PR		451PR		450 × 7.8 mm	35-130 mm	250 N
530PR		531PR		550 × 8 mm	10-160 mm	250 N
550PR		551PR		550 × 4.6 mm	4-160 mm	110 N
580PR		581PR		580 × 12.4 mm	9-168 mm	450 N
610PR		611PR		610 × 8.8 mm	9-181 mm	350 N
760PR		761PR		780 × 9 mm	35-233 mm	350 N
850PR		851PR		850 × 12.6 mm	40-255 mm	450 N
1000PR		1001PR		1000 × 12.6 mm	40-302 mm	450 N

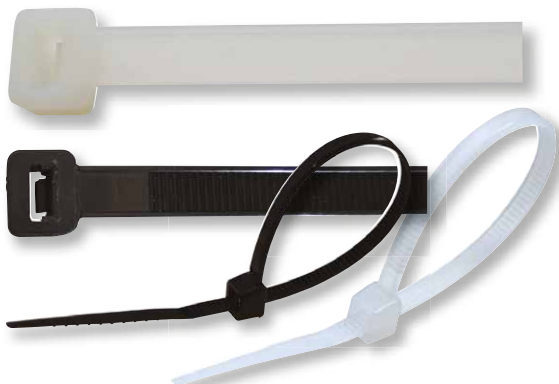

RELEVANT STANDARD
EN 62275



Completely resistant against:
Moderately resistant against:
Non resistant against:

hydrocarbons, alcohols and some organic solvents
organic acids, lyes, reagents and other organic materials
mineral acids and oxidizing agents!



Colored cable ties

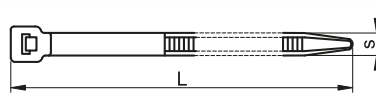
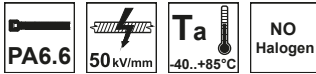

TRACON					
120K		98 × 2.5 mm	1-21 mm	45 N	
150P		140 × 3.6 mm	2-36 mm	80 N	
150Z		140 × 3.6 mm	2-36 mm	80 N	
170P		200 × 3.6 mm	2-50 mm	80 N	
170Z		203 × 3.6 mm	2 - 52 mm	80 N	
190K		200 × 4.8 mm	3-50 mm	110 N	
190Z		203 × 4.6 mm	2 - 52 mm	110 N	
200K		200 × 2.6 mm	1-52 mm	45 N	
230NZ		290 × 3.6 mm	2-80 mm	80 N	

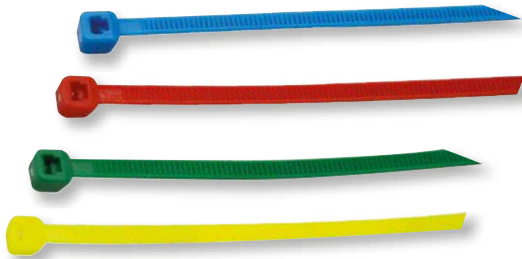

RELEVANT STANDARD
EN 62275

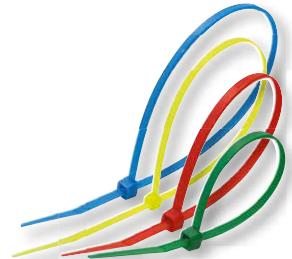

Cable ties with metal blade

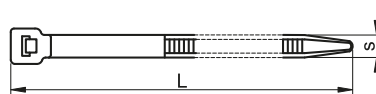
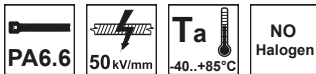

TRACON				
T92		92 × 2.4 mm	2-16 mm	35 N
T140		140 × 3.6 mm	2-29 mm	75 N
T186		186 × 4.8 mm	3.5-45 mm	110 N
T200		200 × 2.4 mm	2-50 mm	35 N
T208		208 × 3.6 mm	2-50 mm	75 N
T281		281 × 3.6 mm	2-76 mm	75 N
T293		293 × 4.8 mm	3.5-78 mm	110 N
T338		338 × 7.6 mm	3.5-120 mm	110 N
T360		360 × 4.8 mm	3.5-102 mm	110 N



UV-proof cable ties

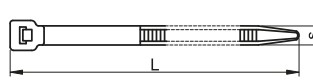

TRACON				
TU92		92 × 2.4 mm	2-16 mm	35 N
TU140		140 × 3.6 mm	2-29 mm	75 N
TU186		186 × 4.8 mm	3.5-45 mm	110 N
TU200		200 × 2.4 mm	2-50 mm	35 N
TU208		208 × 3.6 mm	2-50 mm	75 N
TU281		281 × 3.6 mm	2-76 mm	75 N
TU293		293 × 4.8 mm	3.5-78 mm	110 N
TU338		338 × 7.6 mm	3.5-120 mm	110 N
TU360		360 × 4.8 mm	3.5-102 mm	110 N



PA12 cable ties

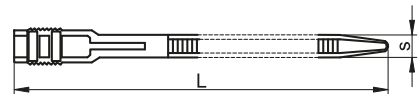

TRACON				
132-12		132 × 9.0 mm	4-27 mm	120 N
180-12		180 × 9.0 mm	5-45 mm	150 N
265-12		260 × 9.0 mm	25-65 mm	250 N
300-12		300 × 9.0 mm	25-80 mm	225 N
360-12		350 × 9.0 mm	25-93 mm	250 N



RELEVANT STANDARD
EN 62275

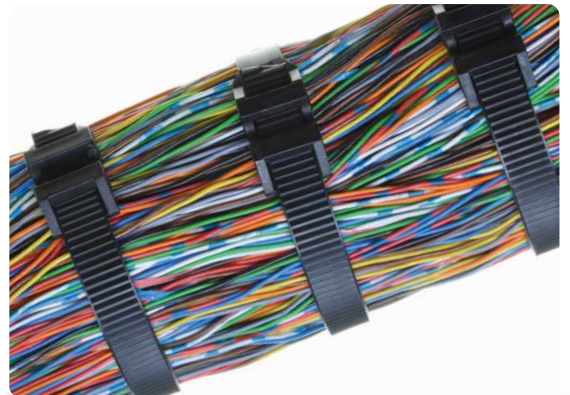

Reusable cable ties

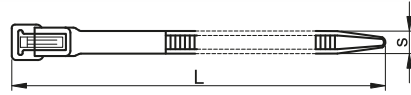

TRACON				
180-NY	181-NY	200 × 7.5 mm	10-50 mm	10-45 N
260-NY	261-NY	250 × 7.5 mm	10-65 mm	10-45 N
280-NY	281-NY	300 × 7.5 mm	10-70 mm	10-45 N
350-NY	351-NY	350 × 8 mm	10-120 mm	10-45 N



Reusable cable ties with pearls

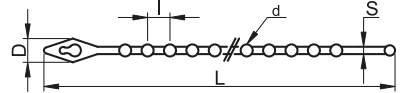

TRACON		L × S (mm)	d (mm)	D (mm)	l (mm)		
100N-GY	100F-GY	1.2 × 100	2.5	4.85	3	3 - 25 mm	45 N
120N-GY	120F-GY	120 × 1.3	2.5	5.5	3	6-25 mm	40 N
150N-GY	150F-GY	150 × 2	3	7.5	4.5	8-35 mm	40 N
160N-GY	160F-GY	1.7 × 150	2.6	7.73	4	4 - 38 mm	40 N
180N-GY	180F-GY	180 × 2	3	7.5	4.5	8-45 mm	40 N
200N-GY	200F-GY	1.8 × 200	2.5	7.63	5	5 - 59 mm	40 N



Heat proof cable tie

PA6.6
50 kV/mm
Ta -40...+105 °C
 NO Halogen

Pictograms **C/O**

TRACON

260T

 365 × 7.8 mm
 8-100 mm
 135 °C (5-8 min)
 250 N

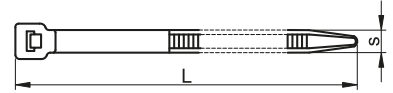
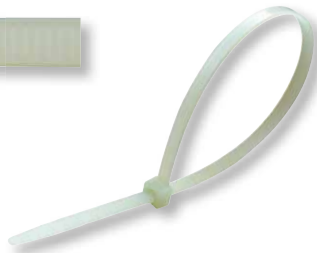

RELEVANT STANDARD
EN 62275

Cable tie with flame retardant

PA6.6
Ta -40...+85 °C
 NO Halogen

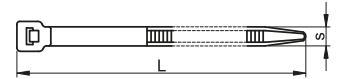

TRACON			
150L	3.6 × 150mm	4 - 36 mm	80 N
200L	4.6 × 200mm	4 - 52 mm	110 N
300L	4 × 300mm	4 - 81 mm	110 N
380L	7.6 × 380mm	9 - 108 mm	250 N

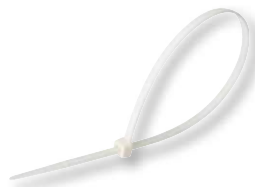

Pinned cable ties

PA6.6
50 kV/mm
Ta -40...+85 °C
 NO Halogen

Pictograms **C/O**

TRACON

BK-130

 130 × 4.8 mm
 d=6 mm
 3-25 mm
 200 N

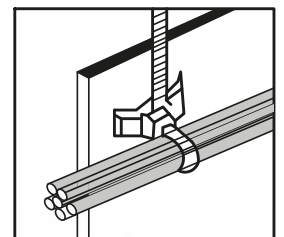
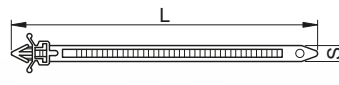
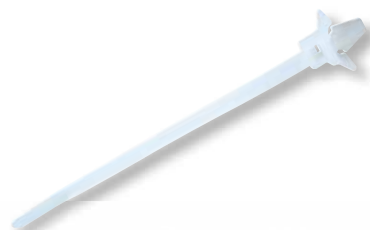

Label-bearing cable ties

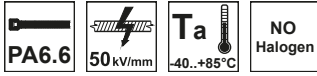

TRACON	L × S (mm)	a (mm)	b (mm)		
120J	110 × 2.5	8	25	1-20 mm	40 N
190J	190 × 3.6	27	13	10-48 mm	70 N
200J	210 × 2.5	15	30	5-45 mm	40 N

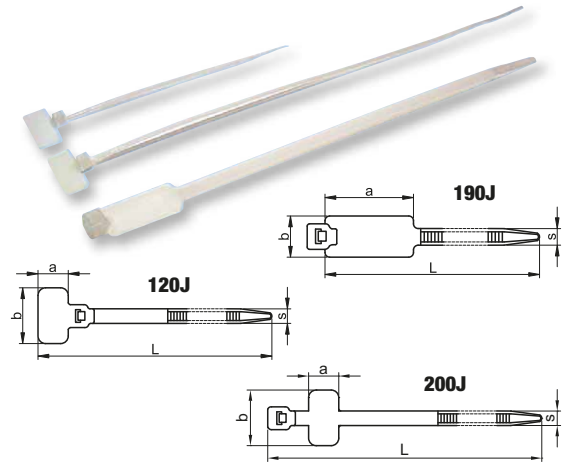

Steel cable tie

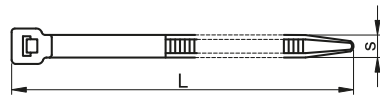

TRACON			
F125	125 × 4.6 mm	15 - 38 mm	350 N
F200	200 × 4.6 mm	15 - 61 mm	350 N
F201	200 × 7,9 mm	15 - 61 mm	450 N
F290	290 × 4.6 mm	15 - 90 mm	350 N
F291	290 × 7,9 mm	15 - 90 mm	450 N
F520	520 × 4.6 mm	15 - 163 mm	350 N
F521	520 × 7,9 mm	15 - 163 mm	450 N
F840	840 × 4.6 mm	15 - 265 mm	350 N
F841	840 × 7.9 mm	15 - 265 mm	450 N

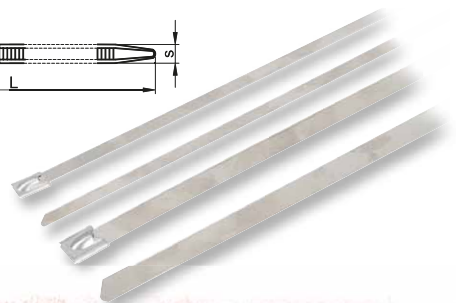
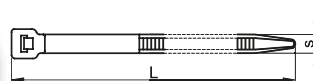

Screw mounted cable tie

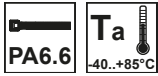

TRACON					
110-CS		110 × 2.5 mm	3 - 19 mm	45 N	M2.5
150-CS		150 × 3.6 mm	3 - 35 mm	80 N	M4
160-CS		160 × 4.8 mm	3 - 36 mm	110 N	M5
200-CS		200 × 4.8 mm	3 - 49 mm	110 N	M5
300-CS		300 × 4.8 mm	3 - 82 mm	110 N	M5
310-CS		300 × 7.6 mm	8 - 78 mm	250 N	M6
370-CS		370 × 4.8 mm	3 - 103 mm	110 N	M5
400-CS		400 × 7.6 mm	8 - 109 mm	250 N	M6

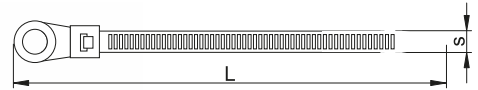

Edge clip cable tie

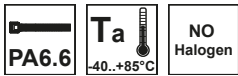

TRACON				
CSKT		4.8 × 200mm	3 - 49 mm	110 N

Maximum edge thickness 3 mm.



Velcro cable organizer



Pictograms

C/O

TRACON			
TKR130		130 × 12,5 mm	35 mm
TKR200		200 × 12,5 mm	35 mm
TKR300		300 × 12,5 mm	89 mm
TKR310		300 × 17 mm	92 mm
TKR-12T		22,8 m × 12,5 mm	-
TKR-20T		25 m × 20 mm	-



Self-adhesive cable holder





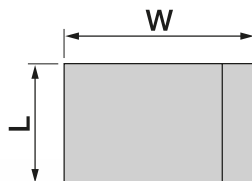
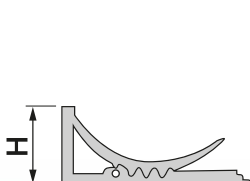

Pictograms

C/O

TRACON		L (mm)	W (mm)	H (mm)
OKT15		15	24	9
OKT20		20	24	9
OKT25		25	24	9
OKT28		28	24	9



Cable tie bases fixed with screws

 PA6.6
 50 kV/mm
 Ta -40...+85°C
 NO Halogen

 Pictograms **C/O**



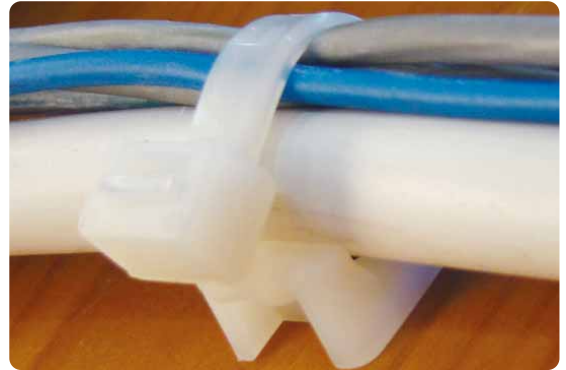
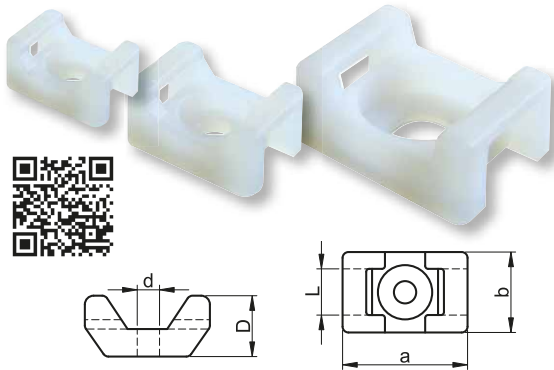

TRACON	a (mm)	b (mm)	L (mm)	d (mm)	D (mm)
CSTALP	15	10	5.1	3.5	7
CSTALP-3	12.8	7	4	3.3	5.8
CSTALP-2	23	16	9	6.3	9.8
CSTALP-4	16	11	5.3	3.5	7
CSTALP-5	22	15	8.3	5	9.5
CSTALP-6	26	16	9.5	5	10.7



Cable tie base, fixing with sticker, with two ways entry

 PA6.6
 UV
 50 kV/mm
 Ta -40...+85°C
 NO Halogen

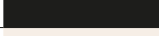
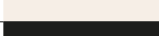
 Pictograms **C/O**

TRACON		a (mm)	b (mm)	L (mm)	d (mm)	D (mm)
TALP190-2		18.7	18.7	4	4.4	5.7
TALP191-2		18.7	18.7	4	4.4	5.7
TALP270-2		26.5	26.5	5.8	4.3	8.1
TALP271-2		26.5	26.5	5.8	4.3	8.1

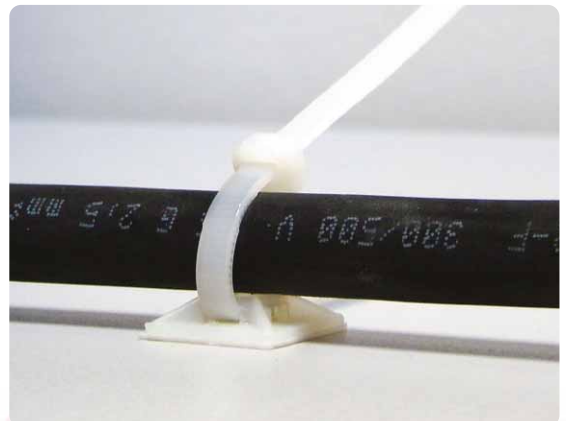
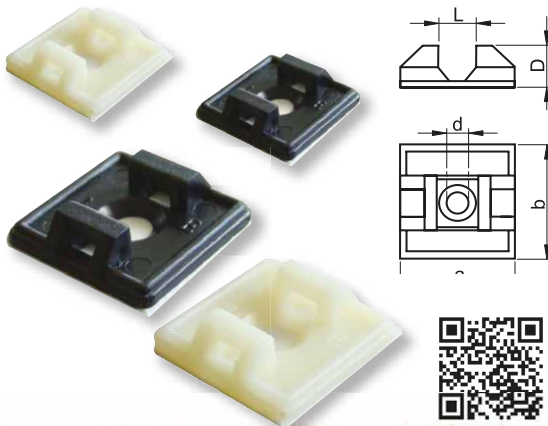

Cable tie base, fixing with sticker, with four ways entry

Pictograms
C/O

TRACON		a (mm)	b (mm)	L (mm)	d (mm)	D (mm)
TALP190		20	20	5	2.9	6.1
TALP191		20	20	5	2.9	6.1
TALP200		19	19	4.3	5	6
TALP201		19	19	4.3	5.7	6.5
TALP270		25	25	6.2	3.5	7.5
TALP271		25	25	6.2	3.5	7.5
TALP280		28	28	5.2	5.7	6.5
TALP281		28	28	5.2	5.7	6.5

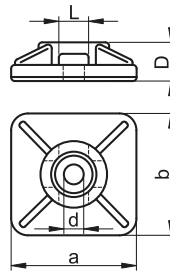

Cable tie fixing plugs

Pictograms
C/O

TRACON			a (mm)	b (mm)	c (mm)	W ₁ (mm)	W ₂ (mm)	L (mm)	D (mm)
5458		8 mm	10.6	6.3	3.1	12.8	12.6	43.8	9.9
5458N		7 mm	9.8	6.4	2.1	15.4	11.1	38.0	7.9
8138		7 mm	10.2	6.4	3	14.6	11	38	9.9
9843		8 mm	10.3	6.5	3.2	12.8	12.9	43.3	9.7

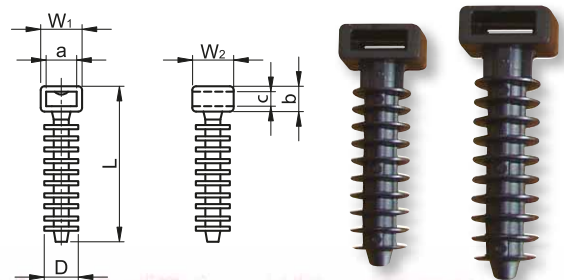
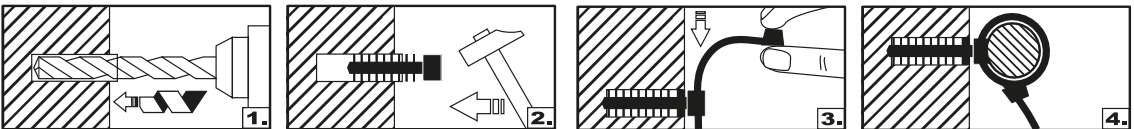

Plastic cable/wire clamps with pin

TRACON			a (mm)	b (mm)
100 pcs	20 pcs			
NOF	NOF-20		2.5	4.5
N1	N1-20		6	7.3
N2	N2-20		8	8.1
N3	N3-20		9	8.3
N4	N4-20		11	10



N1..N4



NOF

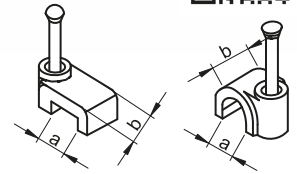
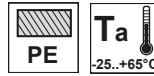

Plastic pipe clip



TRACON		D (mm)	W (mm)	L (mm)	H (mm)
CSS-16			16	29.3	12.9
CSS-20		20	33	12.9	24.2
CSS-25		25	37.5	12.9	27.9

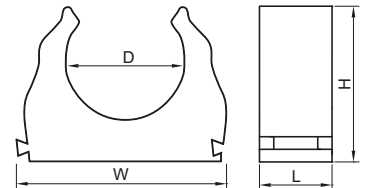

Clips for tubes and cables

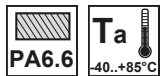

TRACON		d (mm)	W (mm)	L (mm)
TKCR-0708			7-8	20

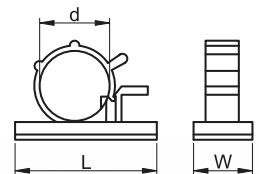

Lockable cable and tube clips

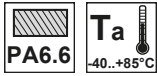

TRACON		d (mm)	L (mm)	H (mm)
TKCRZ-15		15	28	28.5
TKCRZ-18		18	28	33
TKCRZ-22		22	34	37
TKCRZ-28		28	38,5	45
TKCRZ-32		32	38	47.5
TKCRZ-35		35	41	49

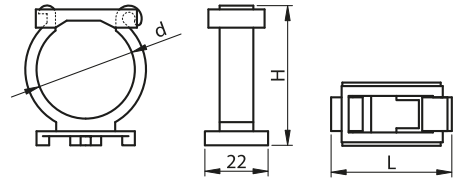

Clips for tubes and cable-like wires

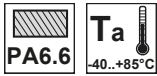

TRACON		a (mm)	b (mm)	L (mm)	I (mm)	H (mm)	W (mm)
BCSV-3		10-18	18.6	26.4	16.2	19.8-37.5	17.7
BCSV-4		19-31	28.8	39.4	15.1	39.5-51.6	18.2

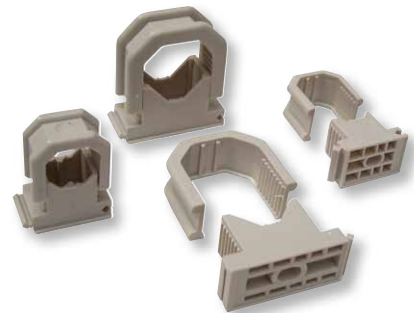

Wire fixing plug

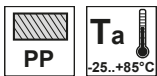

TRACON		d ₁ (mm)	d ₂ (mm)	B (mm)	L (mm)
KRT		6	6	10	36.5
KRT8		8	7.7	12.2	42.7

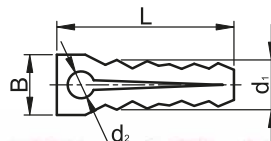

Hammer-in fixing for drywalls



TRACON	D × L (mm)	
GTL30	10,5 × 30	3,5-4 mm
GTL40	10,5 × 40	3,5-4 mm
GTL43	16 × 43	3,5-4 mm

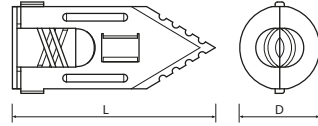

Plug for drywall

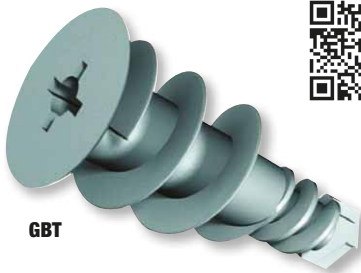

GBT

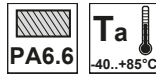

TRACON	Description	D × L (mm)	d × l (mm)*
			
GBT	Self-drill plug for drywalls	16 × 36	4 × 35
GSZT	Plug for drywalls with wings	10 × 55	4 × 50

* Recommended screw size



GSZT

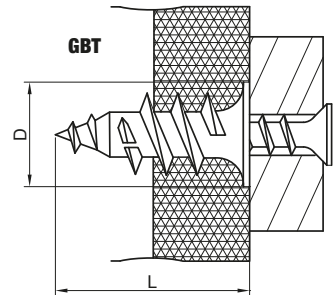
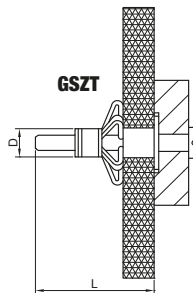

Plasterboard screw for metal (S) and wood (W)



GCSS90

GCSW35

GCSS45

GCSW45

GCSS25

GCSW25

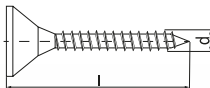



TRACON		
	∅ d1	l (mm)
GCSS25	3,5	25
GCSS35		35
GCSS45		45
GCSS55		55
GCSS70		70
GCSS90	4,2	90
GCSW25	3,5	25
GCSW35		35
GCSW45		45
GCSW55		55
GCSW70		70
GCSW90	4,2	90

for metal

for wood

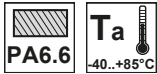
Plug with neck and hexagonal flanged screw



TRACON		
	D x L (mm)	d x l (mm)
T10080P	10 x 80	6.8 x 95
T10100P	10 x 100	6.8 x 115
T10120P	10 x 120	6.8 x 135
T10140P	10 x 140	6.8 x 155
T10160P	10 x 160	6.8 x 175
T10200P	10 x 200	6.8 x 215
T10240P	10 x 240	6.8 x 255
T10300P	10 x 300	6.8 x 315

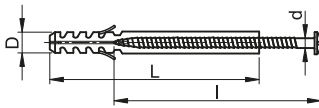

High endurance universal plug

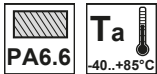

TRACON		
	D x L (mm)	d x l (mm)*
T5-UNI	5 x 25	3.5 x 35
T6-UNI	6 x 30	4 x 40
T8-UNI	8 x 40	5 x 50
T10-UNI	10 x 50	6 x 60

* Recommended screw size

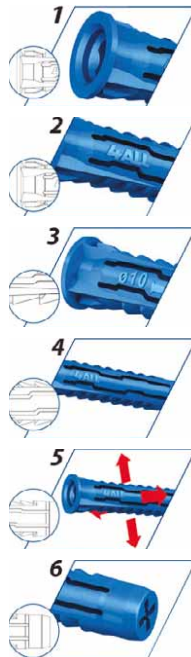
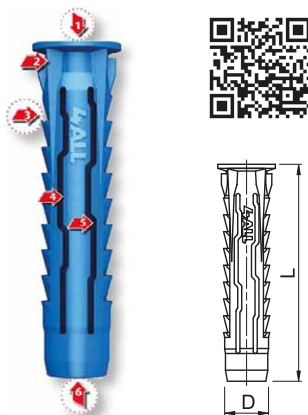

Special interior space for best seat of the bolt.

The ears sit fast in all -even soft- materials preventing the plug to turn.

The toothing behind the head ensures safe fixation in any material.

The expansion part enhances the fixation in the hollow areas of the material.

The opening in four directions makes the plug adapted to walls of any material.

The reinforced tip of the plug ensures proper position of the bolt at installation.



Concrete



Perforated brick



Building plate

Our range of products is continuously and quickly expanding. Our catalogue shows our products as of January 2023. Check our website to stay up-to-date.

SCAN THE QR CODE!

- Check our new products
- Be updated



Normal plug

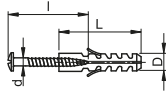
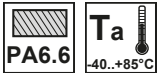

TRACON		D × L (mm)	d × l (mm)
T6-PA	T6CS-PA	6 × 30	4 × 40
T8-PA	T8CS-PA	8 × 40	5 × 50
T10-PA	T10CS-PA	10 × 50	5.5 × 60
T12-PA	-	12 × 60	-
T14-PA	-	14 × 75	-



Collar plug

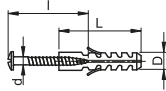
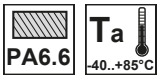

TRACON		D × L (mm)	d × l (mm)
-	T6PCS-PA	6 × 30	4 × 40
T6P-PA	-	6 × 30	4 × 40
T8P-PA	T8PCS-PA	8 × 40	5 × 50
T10P-PA	T10PCSPA	10 × 50	5.5 × 60
T12P-PA	-	12 × 60	-



Self-stretching plug

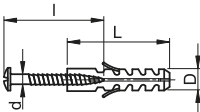
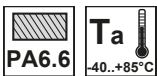

TRACON		D × L (mm)	d × l (mm)
TOP6	TOPCS6	6 × 40	4 × 50
TOP8	TOPCS8	8 × 50	5 × 60
TOP10	TOPCS10	10 × 60	6 × 70



OVO



Square-section plug

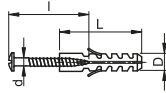
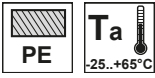

TRACON		D x L (mm)	d x l (mm)
TN6	TNCS6	6 x 23	2.6 x 30
TN8	TNCS8	8 x 34	3.5 x 38
TN10	TNCS10	10 x 42	4.4 x 46
TN12	TNCS12	12 x 52	5.4 x 61
TN14	-	14 x 65	-



Knock-in plug

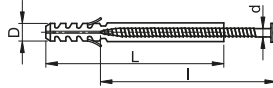
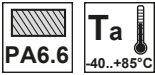

TRACON			TRACON		
	D x L (mm)	d x l (mm)		D x L (mm)	d x l (mm)
TB525	5 x 25	3.5 x 29	TB845	8 x 45	4.9 x 48
TB535	5 x 30	3.5 x 38	TB860	8 x 60	4.4 x 60
TB545	5 x 50	3.5 x 47	TB875	8 x 80	4.7 x 78
TB635	6 x 35	3.7 x 39	TB8100	8 x 100	4.7 x 102
TB645	6 x 40	3.7 x 48	TB8120	8 x 120	4.4 x 122
TB655	6 x 55	3.7 x 58	TB8135	8 x 135	4.4 x 137
TB670	6 x 80	3.2 x 83			



Long plug

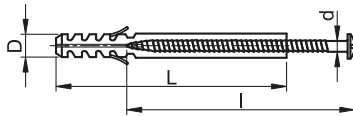
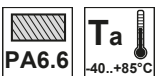

TRACON		D x L (mm)	d x l (mm)
-	THC8100	8 x 100	5.3 x 104
TH8120	THC8120	8 x 120	5.5 x 126
TH8135	THC8135	8 x 135	5.4 x 134
TH10100	THC10100	10 x 100	6.8 x 105
TH10115	THC10115	10 x 115	6.8 x 119
TH10135	THC10135	10 x 135	6.8 x 141
TH10160	THC10160	10 x 160	7 x 165



Collar plugs

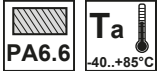

TRACON		D × L (mm)	d (mm)	l ₁ (mm)	l ₂ (mm)	B (mm)
T6H		6 × 30	3.3	37	24.2	15.4
T6K		6 × 30	3.3	38.5	10	13.4

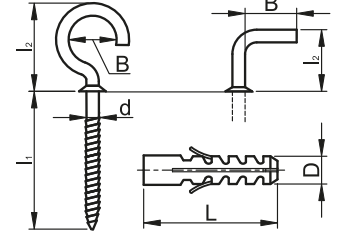

Stainless steel dowels



TRACON	d (mm)	l (mm)	M
RFD6	8	25	M6
RFD8	10	30	M8
RFD10	12	40	M10

Flat-headed self-tapping screw



TRACON	d (mm)	l (mm)
OPCS13	4.2	13
OPCS16	4.2	16
OPCS19	4.2	19
OPCS22	4.2	22
OPCS25	4.2	25
OPCS32	4.2	32



Threaded rod and accessories

Threaded rod

TRACON	M (mm)	l (mm)
SZAL6	6	1.000
SZAL8	8	
SZAL10	10	



Stainless steel threaded rod extension

TRACON	M (mm)	l (mm)
MTOLD6	6	17.9
MTOLD8	8	23.7
MTOLD10	10	30.3



Hexagon nut, self-closing, galvanised

TRACON	M
HANYA06	6
HANYA08	8
HANYA010	10



Hexagon nut, galvanised

TRACON	M
HANYA6	6
HANYA8	8
HANYA10	10



Spring spacer, galvanised

TRACON	M
ALAR6	6
ALAR8	8
ALAR10	10



Flat spacer, galvanised

TRACON	M
ALAL6	6
ALAL8	8
ALAL10	10





Serrated spacer, galvanised

TRACON	M
ALAF6	6
ALAF8	8
ALAF10	10

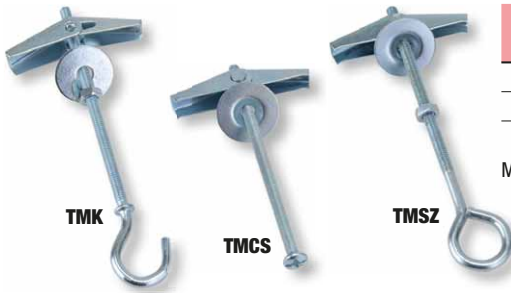

Ceiling bolts



TRACON	d (mm)	L (mm)	a (mm)	B (mm)	
TMK	M4	95	20	14	200 N
TMCS	M4	81	20	–	800 N
TMSZ	M4	93	20	14	200 N

Material: steel, chromed

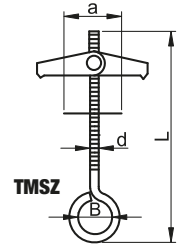
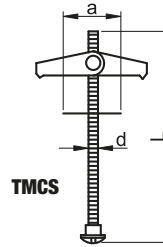
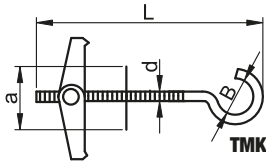

Wire thimble

TRACON	W (mm)	l (mm)	L (mm)	c (mm)	s (mm)	
SZIV-3	4.5	41.6	46.3	17	1	1 – 3 mm
SZIV-4	5.5	37.7	41.7	15	1	3 – 4 mm
SZIV-5	6.2	37.8	42.4	15	1	4 – 5 mm
SZIV-6	9	42.8	47.5	18.1	1	5 – 6 mm
SZIV-8	9.4	47.7	54.5	19.2	1.5	6 – 7 mm
SZIV-10	12.1	53.8	59.7	21.9	1.5	7 – 9 mm
SZIV-12	17.1	62.4	68.5	28.8	1.5	9 – 12 mm
SZIV-16	21.1	75.7	82.9	39.2	2	12 – 14 mm
SZIV-19	21.6	80.6	90.3	42.2	2.3	16 – 19 mm

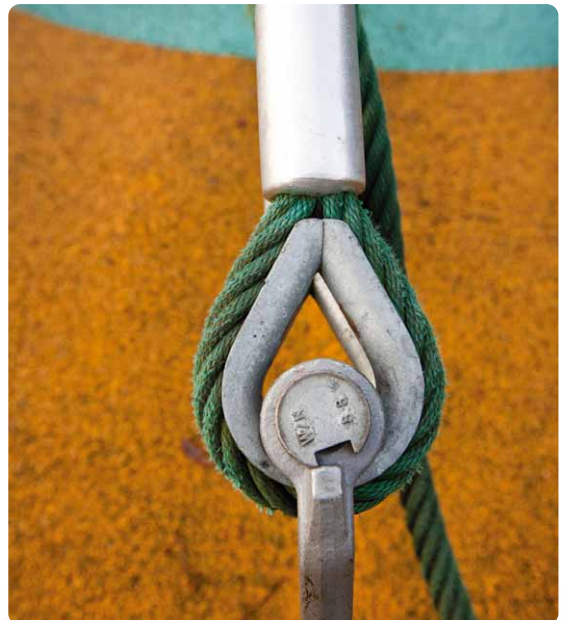
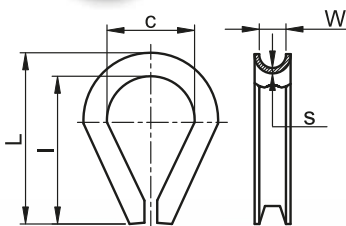

Hook

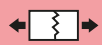
TRACON	d (mm)	L (mm)	l (mm)	m (mm)	D (mm)	
HR3-25	3	26	20.2	3	7	320 N
HR3-30	3	31.1	25.5	4.8	8.8	320 N
HR4-30	4	33.4	25.5	4.8	10	575 N
HR4-35	4	35.3	27.5	5.2	10.2	575 N
HR4-40	4	41	33.3	5.9	10.9	575 N
HR5-45	4.8	46	36.7	6.6	12.5	730 N
HR5-50	5	53.5	44	10.3	15.3	885 N
HR6-80	6	80	69	12	24	1250 N
HR8-100	8	104	88	17	31	2000 N

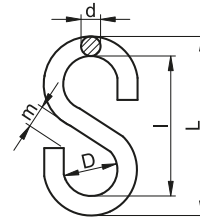

U wire clips

TRACON	d (mm)	D (mm)	W (mm)	H (mm)	h (mm)	L (mm)	 mm
U03	M4	5.4	9.5	20.4	7.3	18	2-3 mm
U05	M5	7.2	9.6	24.2	7.5	21.5	3.2-5 mm
U06	M5	8.0	11.2	24.2	9.5	23.8	4.5-7 mm
U08	M6	9	12.9	35.4	10.4	27.4	6.3-8 mm
U09	M8	10.5	16.6	37.3	12.7	33	8-9 mm
U11	M8	11	18.4	41	16	36.4	10-11 mm
U13	M10	14.8	20.6	54.7	18.7	42.2	12-14 mm
U14	M10	14.9	24.2	55.2	23	43.7	12-14 mm
U16	M10	18.2	26	62	25.2	49.9	14-16 mm
U19	M12	21.5	29.7	76.8	30.2	54.4	16-19 mm
U22	M12	21.5	31	77.8	33.2	56.7	19-22 mm
U25	M14	27.7	32.8	95.7	34.5	63.3	22-25 mm

Material: pressing screw – steel, body – tempered casting

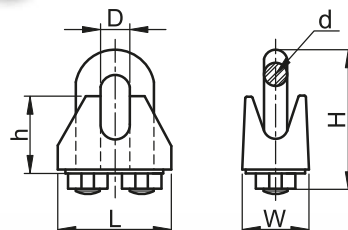

Simple wire clips

TRACON	d (mm)	b (mm)	B (mm)	H (mm)	L (mm)	k (mm)
BSZ1-2	M4	5.1	13.6	6.1	17.2	13
BSZ1-3	M4	6.4	15.3	7	18.4	13.6
BSZ1-4	M5	10	16.6	6.5	21	17.4
BSZ1-5	M5	10.4	18.7	8.9	24.4	16.9
BSZ1-6	M6	12.5	23.3	9.6	30.2	21.6
BSZ1-8	M8	18.6	30.4	13.5	36.5	29.2

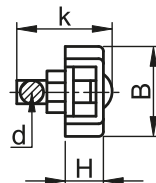
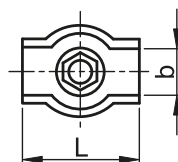

Double wire clips

TRACON	d (mm)	b (mm)	B (mm)	H (mm)	L (mm)	k (mm)
BSZ2-2	M4	5.8	12.9	5	36.6	13.4
BSZ2-3	M4	6.4	15.3	6.7	35.2	13.5
BSZ2-4	M5	8.4	17.5	7.1	40	17.6
BSZ2-5	M5	11.9	20.4	8.8	48.8	19.6
BSZ2-6	M6	12.5	23.3	9.6	60.5	21.6
BSZ2-8	M8	18.6	30.4	13.5	73	29.2

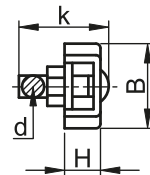
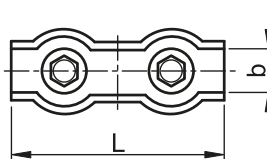

"AMAX" wire clips

TRACON	d (mm)	W (mm)	H (mm)	L (mm)	k (mm)	⌀a
AMAX3	M3	16.1	10.2	28.6	12.7	3 mm (1/8")
AMAX5	M5	17.5	10.7	30.5	12.4	5 mm (3/16")
AMAX6	M6	22.9	12.9	34.9	15.9	6 mm (1/4")

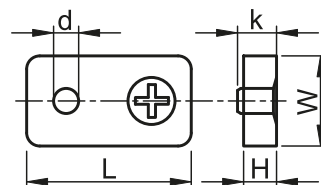

Spring hooks

TRACON	d (mm)	D (mm)	W (mm)	L (mm)	m (mm)	
RKARA4	4.5	5.8	21.1	42.0	5.5	300 N
RKARA5	5	6.6	26	51.3	7.2	500 N
RKARA6	6	6.9	30.2	62.3	7.7	800 N
RKARA7	7	7.8	35.1	70.7	8.7	1100 N
RKARA8	8	8.1	40.4	80.5	10.2	1400 N
RKARA9	9	9.7	45	90.3	11.7	1700 N
RKARA10	10	11.1	47.3	99.8	13.4	2100 N
RKARA11	11	12.3	57.3	121.2	16.5	2500 N
RKARA12	12	13.9	63.2	142.5	20.8	2700 N
RKARA13	13	15.8	72.8	149.4	24.1	3000 N

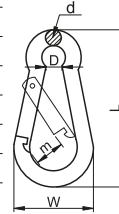



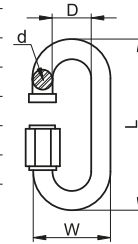

Quick links

TRACON	d (mm)	D (mm)	W (mm)	L (mm)	
CSKARA3,5	3.5	10.8	17.9	35.5	420 N
CSKARA4	4	11.6	19.7	40.6	850 N
CSKARA5	5	13.6	23.5	50.9	1270 N
CSKARA6	6	14.7	26.7	58.3	1700 N
CSKARA7	7	18.4	32	68.2	2550 N
CSKARA8	8	19.6	36	73.8	3100 N
CSKARA9	9	20.6	39.2	82.2	4250 N
CSKARA10	10	21.6	42.4	89.6	5100 N
CSKARA12	12	23.5	48.3	106.2	6400 N



Turnbuckles

TRACON			d (mm)	l (mm)	L (mm)	D (mm)	
							
FSS550	FSH550	FHH550	5	50	92.6	7.8	750 N
FSS570	FSH570	FHH570	5	70	113	8	770 N
FSS660	FSH660	FHH660	6	60	112	10	1050 N
FSS6100	FSH6100	FHH6100	6	100	154	10.2	1800 N
FSS870	FSH870	-	8	70	137	12.3	1200 N
FSS8110	FSH8110	FHH8110	8	110	176	12.3	2000 N
FSS10120	FSH10120	FHH10120	10	120	194	13.3	3000 N
FSS12130	FSH12130	FHH12130	12	130	224	18.3	4450 N
-	FSH16140	-	16	140	265	22	5950 N

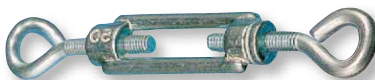

FSS



FHH

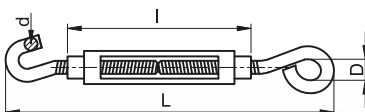

FSH

Long link chain



TRACON				
	A (mm)	B (mm)		C (mm)
LANC4	4	16	40	25
LANC5	5	20	45	25
LANC6	6	24	54	20

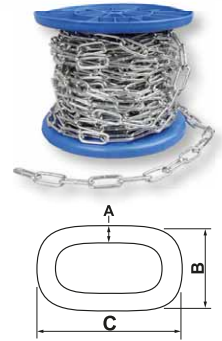

PVC insulated wire-rope



TRACON	$\varnothing d$ (mm)	
DK0T3	3	100
DK0T4	4	100
DK0T5	5	100



Cable tie spiral



TRACON		d (mm)	D (mm)	s (mm)		
SPI6		6.2	8.6	1.9	1 m	6 mm
SPI8		8	10.9	2.4	1 m	8 mm
SPI10		10	13.2	2.9	1 m	10 mm
SPI12		12	15.4	2.9	1 m	12 mm
SPI15		15	17.1	2.9	1 m	15 mm
SPI20		20	24	3	1 m	20 mm
SPI25		25	28.7	3	1 m	25 mm

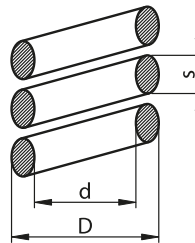



PRODUCTION OF UNIQUE JUNCTION BOXES FOR INDIVIDUAL NEEDS















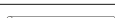

Cable tie tape spiral





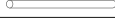





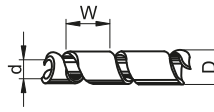

TRACON		D (mm)	d (mm)	W (mm)		
KSPI-4N 	KSPI-4F 	4.5	3.2	6.8	10 m	4...20 mm
KSPI-6N 	KSPI-6F 	6.9	5.3	10.3	10 m	7...40 mm
KSPI-8N 	KSPI-8F 	8.4	6.6	11.7	10 m	12...50 mm
KSPI-10N 	KSPI-10F 	10.2	8.2	13.4	10 m	13...70 mm
KSPI-12N 	KSPI-12F 	12.2	9.6	15.9	10 m	15...80 mm
KSPI-16N 	KSPI-16F 	15.7	12.4	21.6	10 m	20...120 mm









Pictograms

Flexible and expandable cable sleeve















TRACON		
TKH-003 	3 mm	2.4 – 6.4 mm
TKH-010 	10 mm	4.8 – 15.9 mm
TKH-016 	16 mm	9.5 – 25.4 mm
TKH-025 	25 mm	15.9 – 36.1 mm
TKH-032 	32 mm	19.1 – 44.5 mm



In addition to a mechanical protection, these cable sleeves fit the cable and adapt themselves to the different diameters. The sleeves can be tailored with a special iron edge or a hot knife to avoid curling and damages. The woven structure does not retain heat and humidity.

Self-locking woven cable stockings

TRACON	
OFK9 	9 mm
OFK16 	16 mm
OFK25 	25 mm
OFK38 	38 mm

